



CONTENTS

MT5000/4000 SERIES HMI AND PLC CONNECTING GUIDE	3
SERIAL COMMUNICATION PIN DEFINITION.....	3
PARALLEL PORT PIN DEFINITION	3
PRINTER CONNECTING CABLE DIAGRAM	4
DOWNLOAD CABLE DIAGRAM.....	10
COMMUNICATION SETTINGS AND GUIDE OF HMI CONNECTING WITH CONTROLLER.....	11
ABB Corporation	11
Allen-Bradley	14
ACS-Tech80 Motion Controller.....	24
ADAM.....	25
AysjNet.....	28
Baldor NextMove ES(Motion Controller).....	29
Barcode	32
Baumuller.....	33
Bosch Rexroth KVFC+ (Frequency Converter).....	34
Bosch Rexroth.....	35
Bosch Rexroth Ethernet	44
CANOpen Node Slave	48
Danfoss Inverter	55
Delta Corporation.....	61
Delta (Temperature Controller).....	64
D3CellTM	71
EB-MOD2P-01(Bus Bridge).....	72
ENDA.....	78
Emerson NetWork Power.....	79
Epower	83
eView Master & Eview Slave(Master/Slave Protocol Connection).....	85
Facon Corporation.....	87
Fuji SPB	91
GE Fanuc Automation Inc.....	93
HAIWELL.....	98
HanG	100
Hitachi Inverter	101
Hitachi IES Co., Ltd.....	103
Hollysys Corporation	108
HuaDA HD-JZ06.....	110
IDEC Corporation	112
KDN Corporation.....	113
Kinco Corporation.....	115
Kinco ED Series	117
Keyence Corporation.....	119

Koyo Corporation.....	122
KTC Srdlink.....	125
LENZE Inverter.....	127
LS Industrial Systems Co., Ltd.	129
LUST BUS Inverter.....	138
Matsushita Electric Corporation.....	139
Memory map.....	144
Mitsubishi Electric Corporation.....	145
Mks controller.....	162
ModBus.....	163
OE MAX.....	167
Omron Corporation.....	169
OMRON E5EZ-R3(Temperature Controller).....	177
OPTO 22.....	179
Parker Compax3 (Servo Controller).....	182
PMAC Motion Controller.....	185
Power-one AURORA Wind Inverter.....	186
Profibus Slave.....	188
RF-IC (Card Reader).....	193
Saia-Burgess.....	194
Sailsors D9 (Temperature Controller).....	196
Schneider Electric, Ltd.....	198
SHIMADEN FP23.....	207
SIEMENS.....	210
TAIAN.....	226
TMCM_303.....	228
THINGET Controller (Support MODBUS RTU Protocol).....	230
Trio motion controller.....	232
Vigor Corporation.....	236
XiLin Inverter.....	238
Yamatake Corporation.....	240
Yaskawa Inverter.....	245
Yaskawa UDP.....	246
Yaskawa MP2300 (Motion Controller).....	251
Yaskawa SGDM (Servo Controller).....	252
YuDian AI.....	254

MT5000/4000 Series HMI and PLC connecting guide



Serial Communication Pin definition

Pin Designations	Pin assignment of the 9-pin male, D-SUB, COM0/COM2 . This port is used to connect MT5000/MT4000 series touch screens and provides RS-232/485/422 port.					
	Note: The COM2 port is used for programming and debugging, and it is also used for communication, but only provides RS-232 port controller.					
COM0/COM2 (male)	Pin #	Signal	PLC [RS-422] 4 wire	PLC [RS-485] 2 wire	PLC [RS-232]	PC / PLC [RS-232]
	1	Rx-(B)	RS485 Rx	RS485B		
	2	RxD_PLC			RS232 Rx	
	3	TxD_PLC			RS232 Tx	
	4	Tx-	RS485 Tx			
	5	GND	Signal ground			
	6	Rx+(A)	RS485 Rx	RS485A		
	7	RxD_PC/ PLC				RS232 Rx
	8	TxD_PC/ PLC				RS232 Tx
	9	Tx+	RS485Tx			
Pin Designations	Pin assignment of the 9-pin female, D-SUB, COM1 . This port is used to connect MT5000/MT4000 series touch screens and provides RS-232/485/422 port.					
	Pin assignment of this port is basically the same as COM0. The only difference is that COM0 is connected with the RS-232 interface of the PC to serve as the hardware flow control signal for PLC-232 connection.					
COM1 (female)	Pin #	Signal	PLC [RS-422] 4 wire	PLC [RS-485] 2 wire	PLC [RS-232]	
	1	Rx-(B)	RS485 Rx	RS485B		
	2	RxD_PLC			RS232 Rx	
	3	TxD_PLC			RS232 Tx	
	4	Tx-	RS485 Tx			
	5	GND	Signal ground			
	6	Rx+(A)	RS485 Rx	RS485A		
	7	CTS_PLC			Clear to send	
	8	RTS_PLC			Request to send	
	9	Tx+	RS485 Tx			

Parallel Port Pin Definition

The parallel printer port on the back of case can be used to connect with various parallel port printers on the market.

Printout	The full series of MT5000/MT4000 products support printout function. The printing port will export data when the printing component works. The MT5000/MT4000 series touch screens support multiple printers, and Kinco
-----------------	---

	HMItek Ltd. will continuously provide drivers for various brands of printers. Note: The maximum distance of printer cable is 5m.					
Pin Designations  PRINTER(15-pin)	Pin assignment of 15-pin , D-SUB, female, parallel printer port					
	Pin#	Signal	Function	Pin#	Signal	Function
	1	GND	Signal ground	10	BUSY	Input
	2	DATA7	Output	11	DATA8	Output
	3	DATA4	Output	12	DATA5	Output
	4	DATA1	Output	13	DATA2	Output
	5	STB	Output	14	INIT	Output
	7	DATA6	Output	15	nERROR	Input
 PRINTER(25-pin)	Pin assignment of 25-pin , D-SUB, female, parallel printer port					
	Pin#	Signal	Function	Pin#	Signal	Function
	1	STB	Output	8	DATA7	Output
	2	DATA1	Output	9	DATA8	Output
	3	DATA2	Output	11	BUSY	Input
	4	DATA3	Output	15	ERROR	Input
	5	DATA4	Output	16	INIT	Output
	6	DATA5	Output	18-25	GND	Signal ground
7	DATA6	Output				

Printer Connecting Cable Diagram

1. Parallel Printer Cable of SPRT SP-DN16PH/ WH4008A31-053 Printer

Note: WH4008A31 support printing of 240 dots width.

When use parallel interface, you should mount W1 block, parallel connect WA to WB for TTL level.



The MT4300 series touch screens cable diagram: As follows

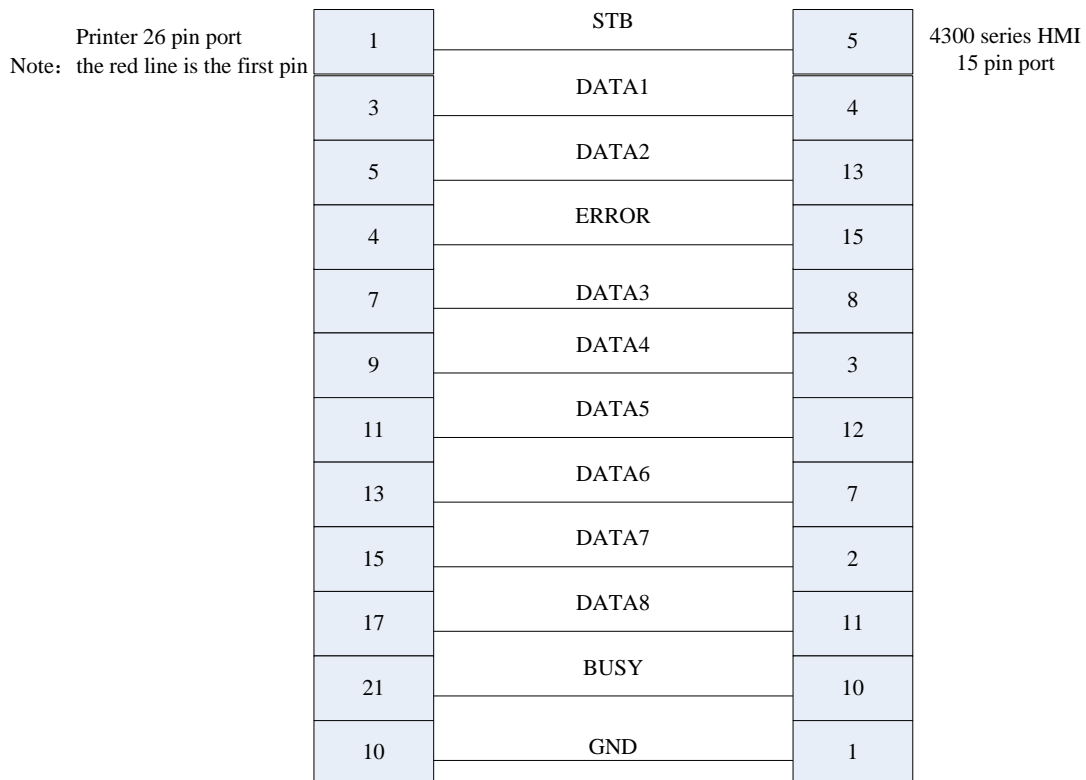

The MT5000 series touch screens cable diagram: As follows

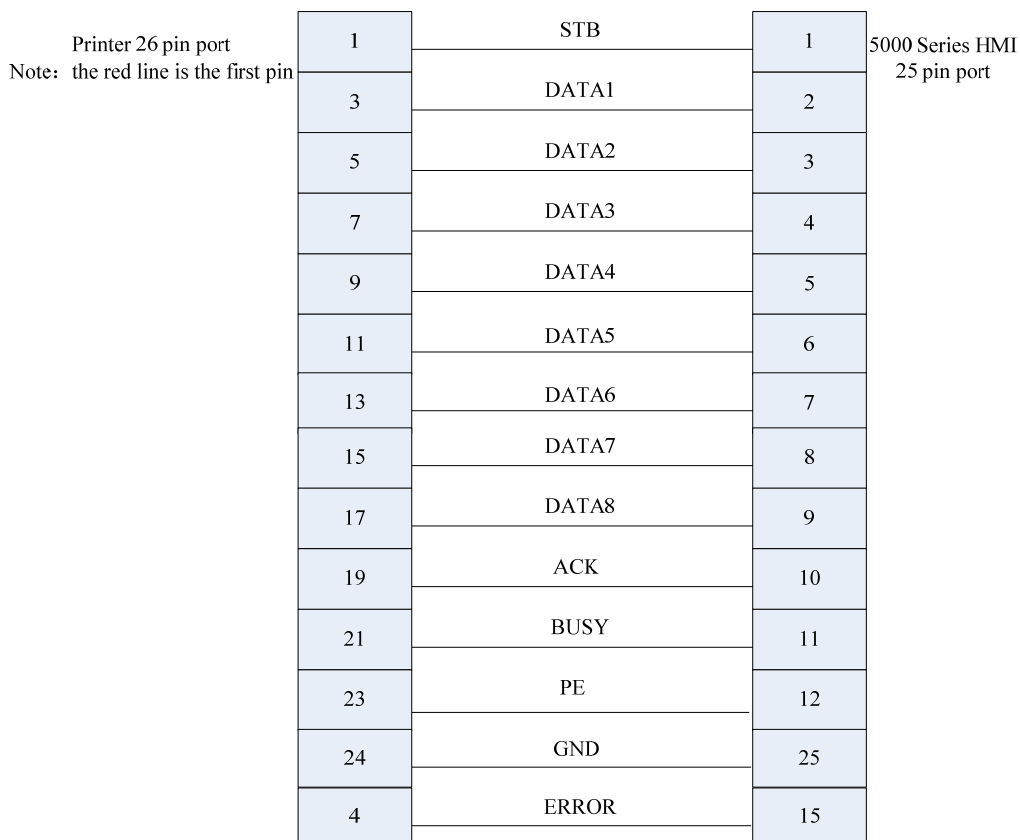

2. Serial Interface Printer Cable of Bright Printer

a. **WH4008A31-053** Serial port printing mode, pulling up W1 short circuit block by RS232 level.

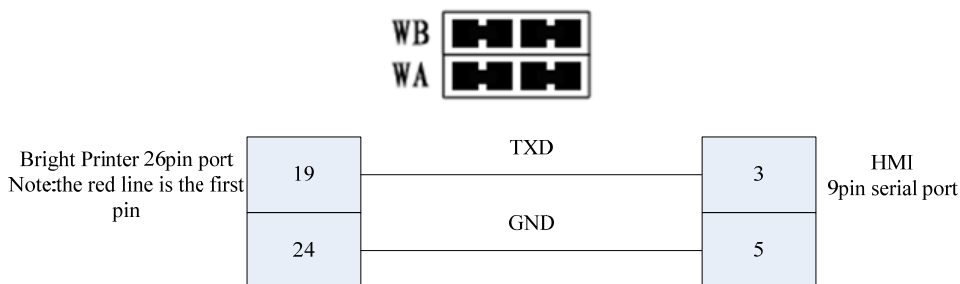

b. **WH-A62R10** support printing of **190 dots** width.

Serial port printing mode via RS232 level, short circuit as follows:

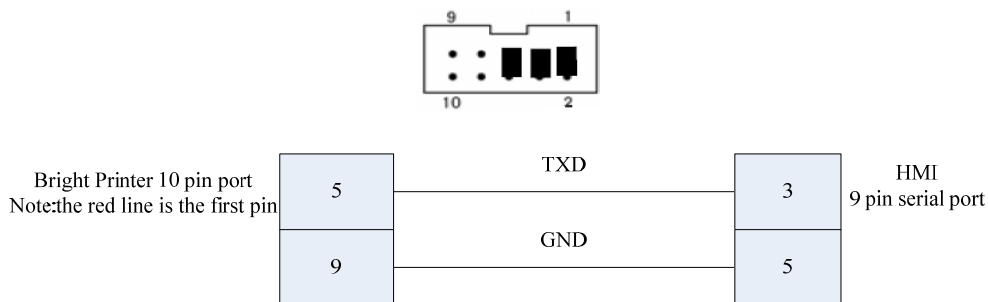

c. **WH-A52Z20-30E125** support printing of **240 dots** width.

Serial port printing mode via RS232 level, short circuit as follows:

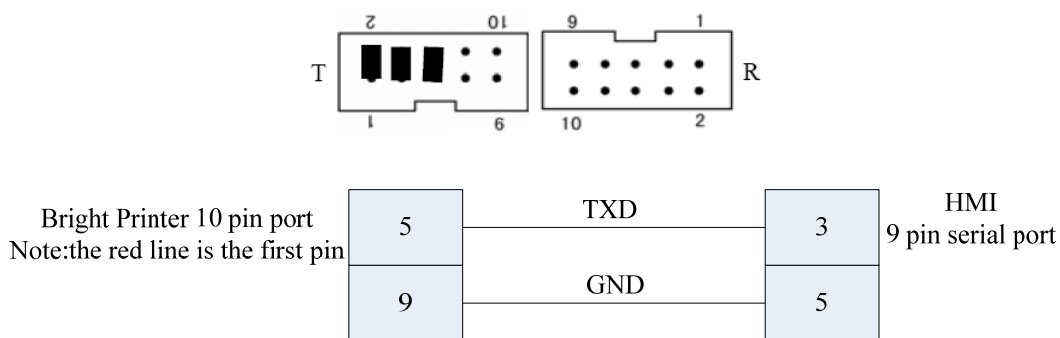

d. **WH-A93RG0-00E825** now support printing of **384 dots** width

Serial port printing mode via RS232 level, short circuit as follows:

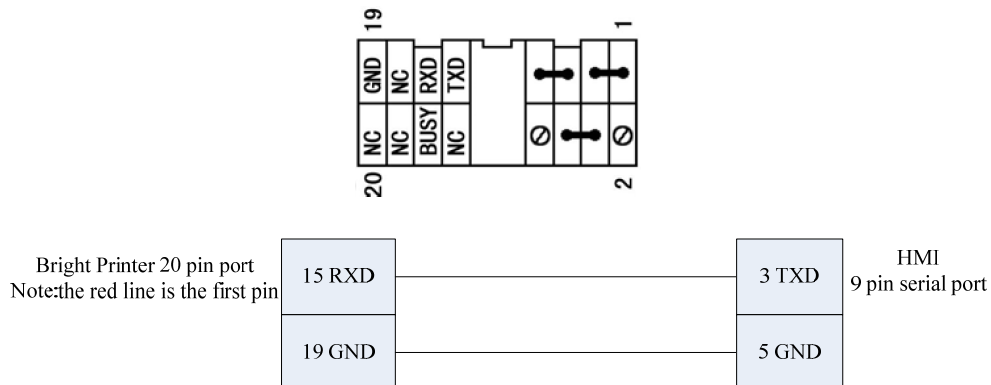

3. Siupo Printer cable

a. **SP-E40004SK** serial printer supports 240 dots width.

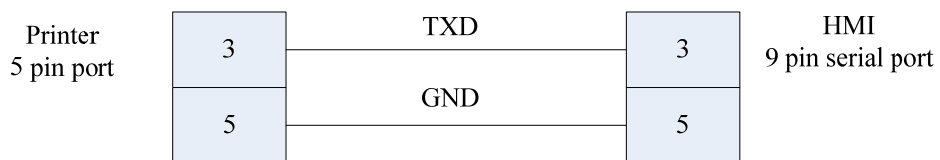

4. Parallel Printer Cable of EPSON/HP Printer

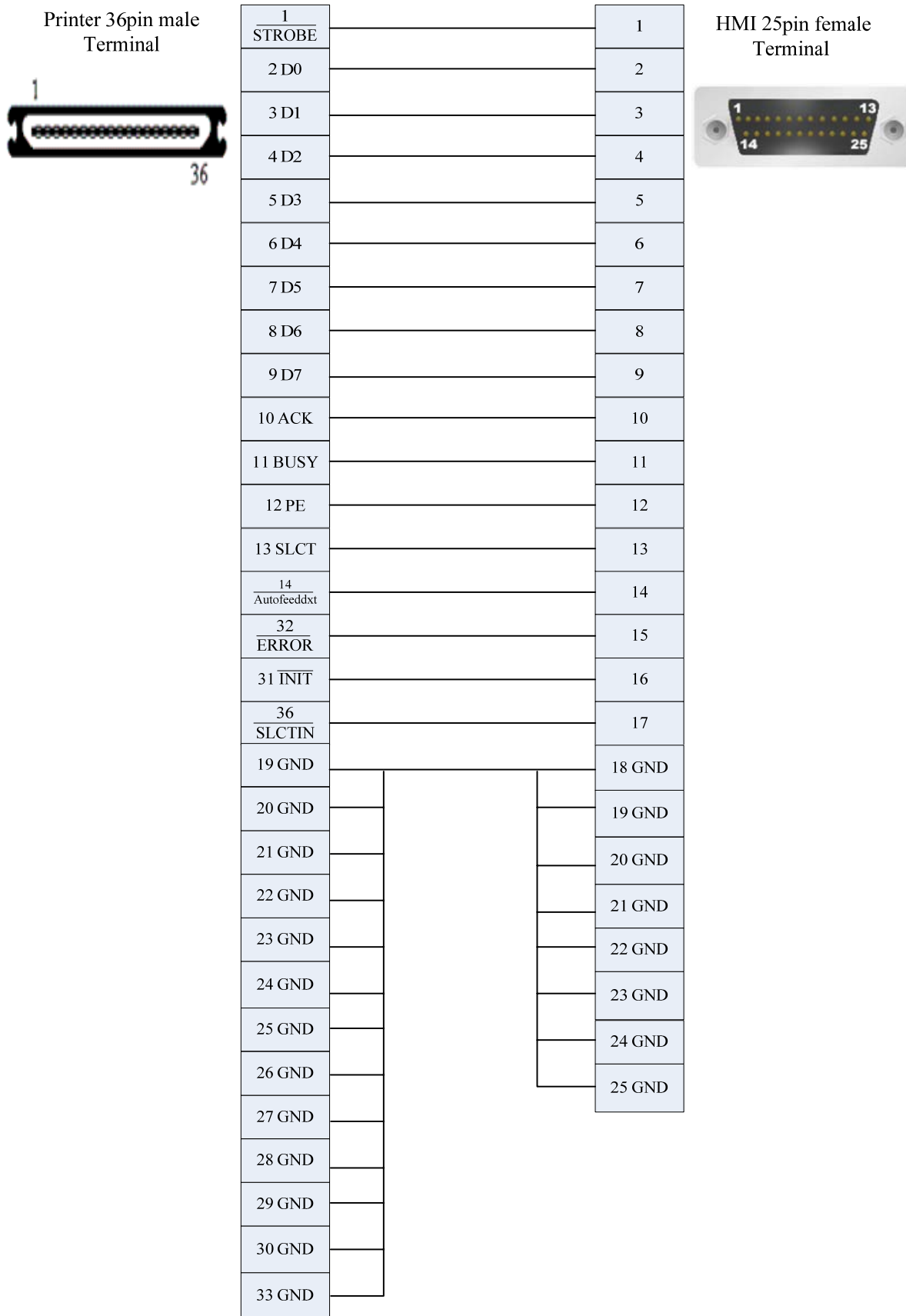

Printer series 25 pin convert to 15 pin of the MT4300 series touch screen

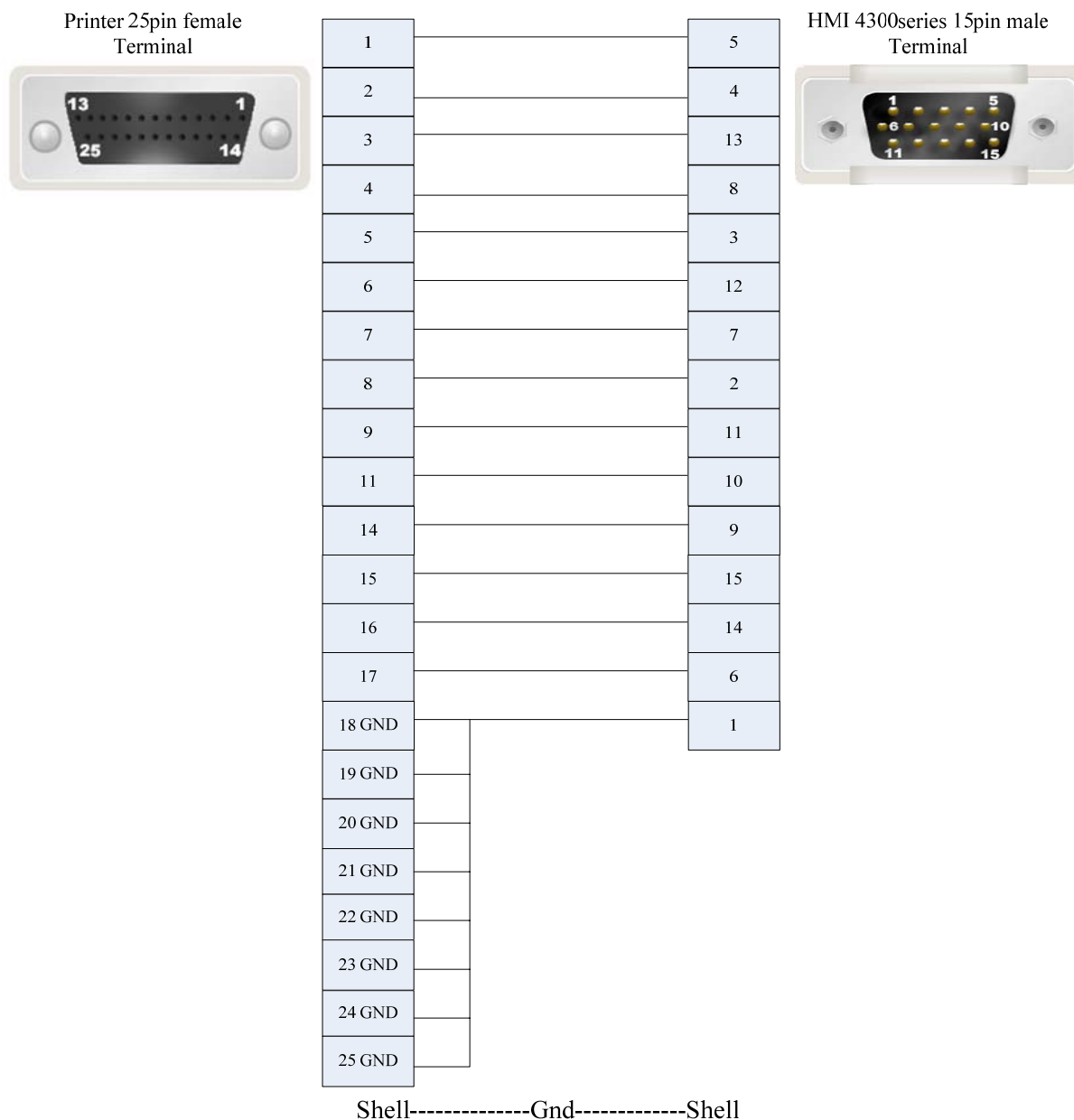

5. Recommend Optional printer

Printer Driver	Printer model	Interface	Print Structure	Print format
EPSON ESC/P	EPSON ME30	USB	inkjet printer	A4
EPSON ESC/P2	EPSON LQ305KT	Parallel	Stylus printer	A4
	EPSON LQ-630K	USB	Stylus printer	A4
HP PCL5e	HP LaserJet p2014	Parallel \USB	laser	A4
SPRT SP-DN16PH	SP-DN16PH	Parallel	Stylus micro printer	240 dots/line
	SP-RMDIV16PH	Parallel	thermal	240 dots/line
WH4008A31-053	WH4008A31-053	Parallel \serial	Stylus micro printer	240 dots/line
	WH4008A31	Parallel \serial	Stylus micro printer	240 dots/line
	WH-A52Z20-30E125	Parallel	Stylus micro printer	240 dots/line
WH-A62R10	WH-A62R10	Parallel	thermal	192 dots/line
	WH-A93RG0-00E725	Serial	thermal	192 dots/line

WH-A93RG0-00E825	WH-A93RG0-00E825	Serial	thermal	384 dots/line
SP-M, D, E, F	SP-E4004SK	Serial	Stylus micro printer	240 dots/line

Download Cable Diagram

Download by Serial Port

The COM2 port on the back of the case can be used to connect PLC RS-232 devices and can also be used to connect with the programming interface and setting interface of a PC.

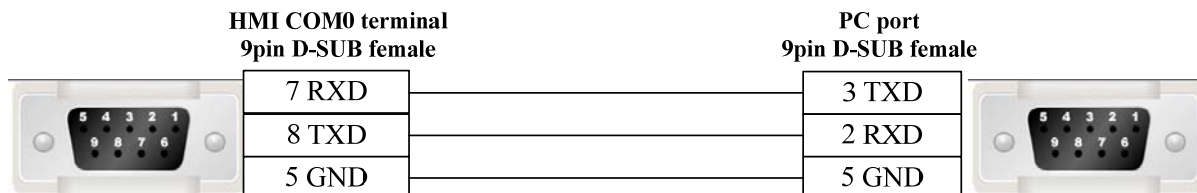

Download by USB

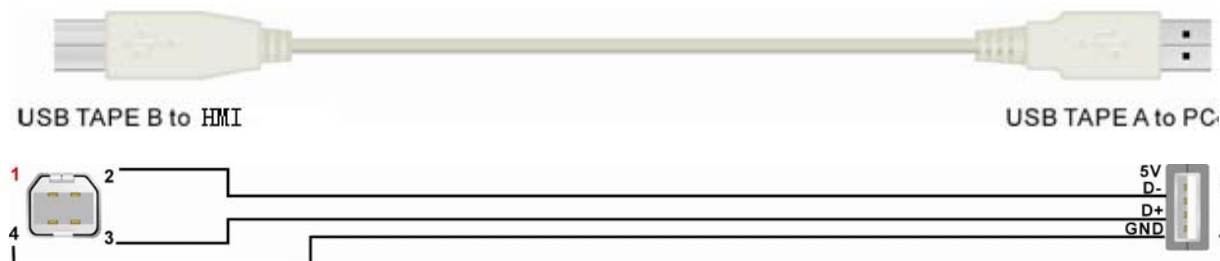

Download by Network Ethernet

Connecting PC and HMI use cross-ruling; communicating with hub or switch use Cross-over cable or cross-ruling.

a. cross-ruling cable diagram:

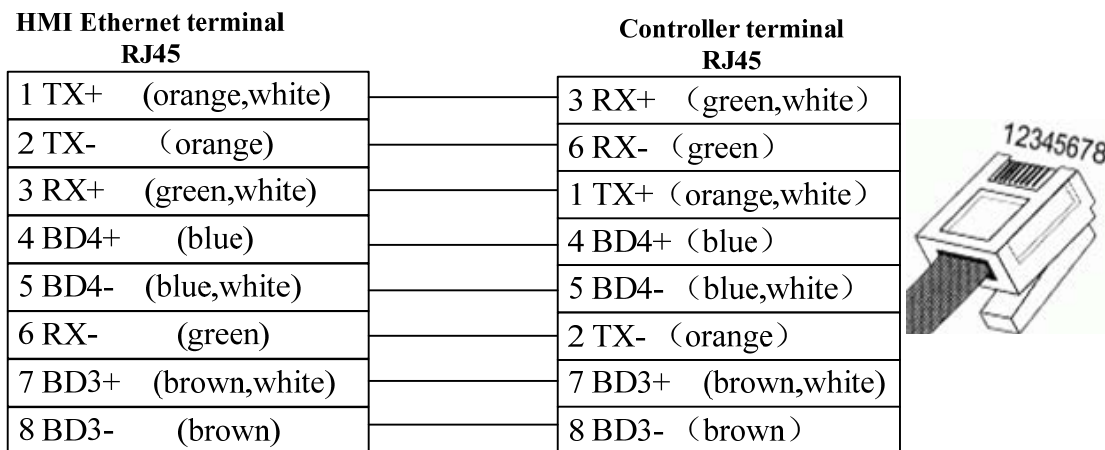

b. cross-over cable diagram:

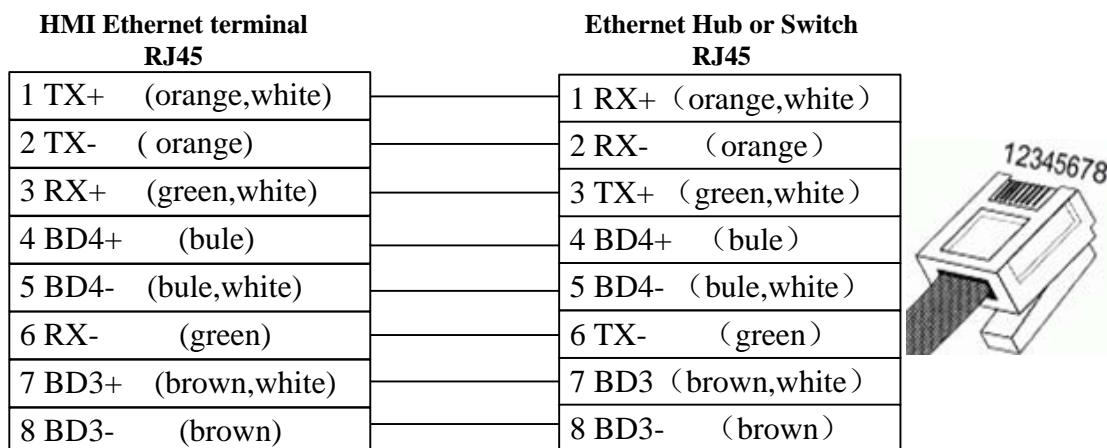

Communication Settings and guide of HMI connecting with Controller

Note: Don't live plug!

ABB Corporation

Serial Communication

Series	CPU	Link Module	Driver
ABB AC31	O7KR51-V3.6	RS232 on the CPU unit	ABB AC31 Modbus RTU
		RS485	
ABB AC500	PM571 PM581 PM591	RS232 on the CPU unit	ABB AC500

System configuration

Series	CPU	Link Module	COMM Type	Parameter	Cable
ABB AC31	O7KR51-V3.6	RS232 on the CPU unit	RS232	Setting	Your owner cable
		RS485	RS485-2	Setting	Your owner cable
ABB AC500	PM571 PM581 PM591	RS232 on the port 1	RS232	Setting	Your owner cable
		RS232 on the port 2	RS232	Setting	Your owner cable

Communication Settings

HMI

ABB AC31: Default communication parameters 9600, 8, none, 1; station No. : 1
[RS232](#)

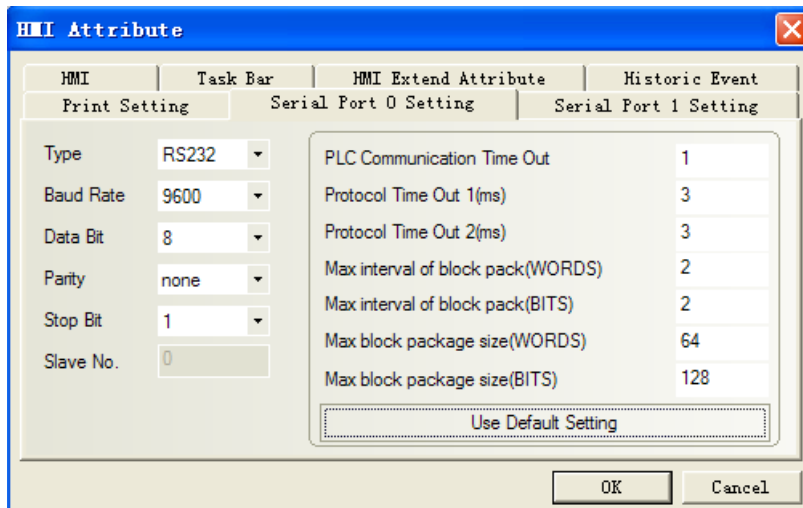

RS485



ABB AC500: Default communication parameters 9600, 8, none, 1; station No. : 1
RS232



Supported Device

ABB AC31

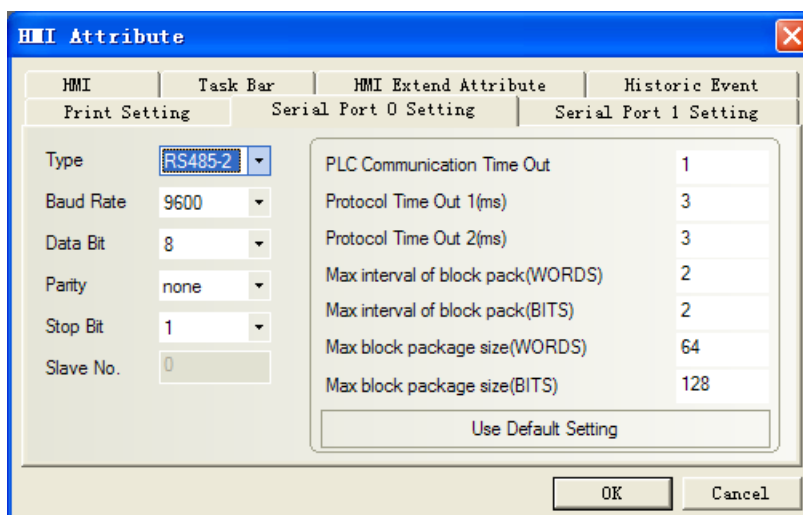
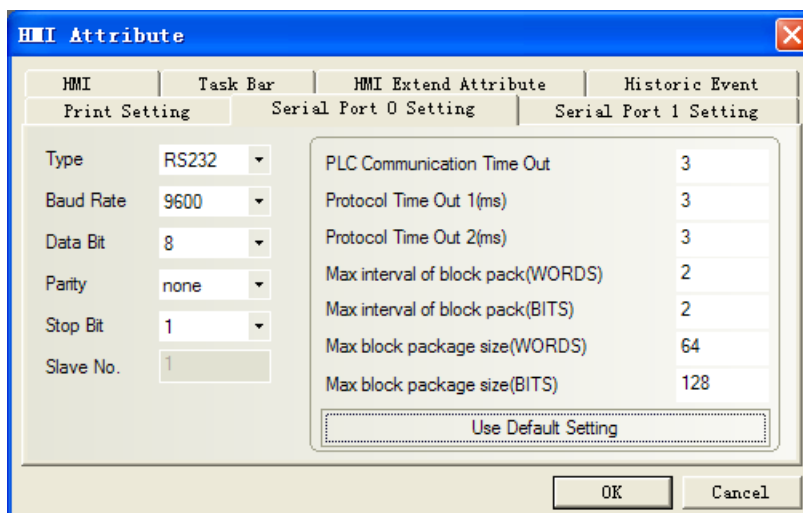
Device	Bit Address	Word Address	Format
Input bit	I00.00-68.15	-----	DD.DD
Output bit	O00.00-68.15	-----	DD.DD
Internal Relay	M(0.0--99.15)U(233.00-255.15)	-----	DDD.DD
Link Relay	S000.00-125.15	-----	DDD.DD
Input Register	-----	IW00.00-68.15	DD.DD
Output Register	-----	OW00.00-68.15	DD.DD
Internal Register	-----	MW(0.0--99.15)U(233.00-255.15)	DDD.DD
Indirect Register	-----	KW01.00-31.15	DD.DD
Internal Register (Double words)	-----	MD0.00-7.15	D.DD
Indirect Register (Double words)	-----	KD0.00-7.15	D.DD

ABB AC500

Device	Bit Address	Word Address	Format
PLC Register	MB0.0—8191.7	-----	DDDD.O
Internal Register	-----	MW0.0—1.32767	D.DDDDD
Internal Register (Double words)	-----	MD0.0—1.16383	D.DDDDD

Note:

- 1) Select "MODBUS" mode in the ABB AC500 programming software;
- 2) If selecting "COM1 MODBUS", serial communication setting must be "slave" in the 15th "Operation mode". Other parameters match the touch-screen.
- 3) Example: MB address: 0.0.1, please input 0.1 in the HMI.

Cable Diagram

ABB AC31 RS232



ABB AC31 RS485



ABB AC500 port1 RS232

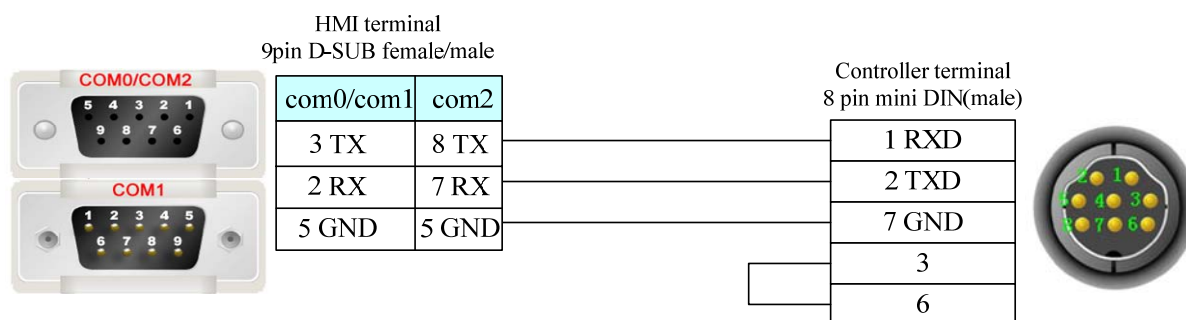

ABB AC500 port2 RS232

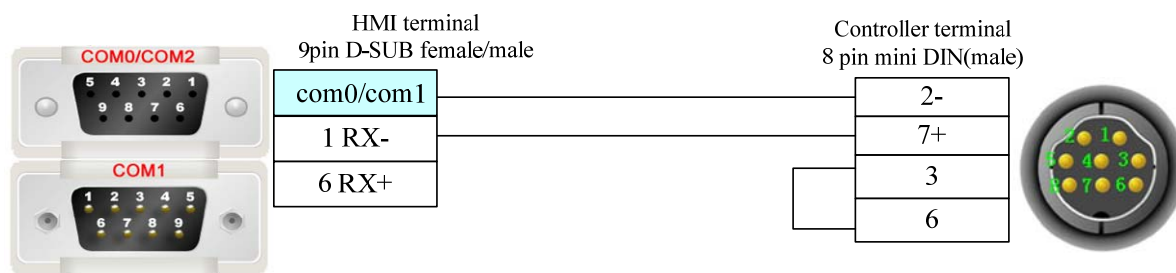

Allen-Bradley

Serial Communication

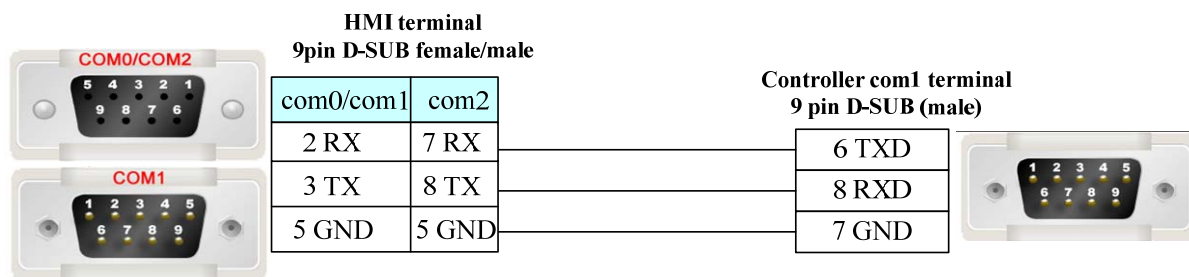
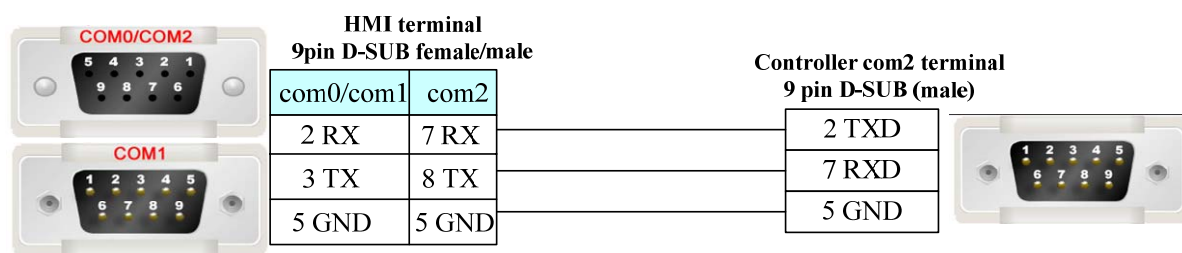
Series	CPU	Link Module	Driver
MicroLogix	MicroLogix 1500 (1764-LRP)	Channel 1	AB DF1
	MicroLogix 1000	Channel 0	
	MicroLogix 1200	AIC+ Advanced Interface Converter	
	MicroLogix 1500 (1764-LSP,1764-LRP)	1761-NET-AIC	
SLC500	MicroLogix 1400 (1766-L32BWAA)	Channel 0	1770-KF3 2760-RB 1775-KA
	SLC 5/03 SLC 5/04 SLC 5/05	Channel 2	

		5130-RM	
		1771-KGM	
PLC-5	PLC-5/11 PLC-5/20 PLC-5/30 PLC-5/40 PLC-5/40L PLC-5/60 PLC-5/60L	Channel 0	
CompactLogix	1769-L20 1769-L30 1769-L31 1769-L32E 1769-L35E	Channel 0 Channel 1	AB CompactLogix/ControlLogix
ControlLogix	1756-L61 1756-L63	CPU Direct	AB CompactLogix/ControlLogix

Ethernet Communication (Direct Online Simulation disable)

Series	CPU	Link Module	Driver	
MicroLogix	MicroLogix 1100 MicroLogix 1400	CPU Direct (channel 1)	AB EtherNet/IP Slave	
	MicroLogix 1000 MicroLogix 1100 MicroLogix 1200 MicroLogix 1400 MicroLogix 1500	1761-NET-ENI		
	SLC500	SLC5/05		CPU Direct (channel 1)
		SLC5/03 SLC5/04 SLC5/05		1761-NET-ENI
		PLC-5		ALL CPUs that support the link I/F on the right

Serial System Communication

Series	CPU	Link Module	COMM Type	Parameter	Cable
MicroLogix	MicroLogix 1500 (1764-LRP)	Channel 1	RS232C	Setting	Your owner cable
	MicroLogix 1000 MicroLogix 1200 MicroLogix 1500	Channel 0			Your owner cable
		AIC+ Advanced Interface Converter 1761-NET-AIC			Your owner cable

	MicroLogix 1400	Channel 0	RS232C	Setting	Your owner cable
		Channel 2			Your owner cable
SLC500	SLC 5/03 SLC 5/04 SLC 5/05	Channel 0 1770-KF3 2760-RB 1775-KA 5130-RM 1771-KGM	RS232C	Setting	Your owner cable
PLC-5	PLC-5/11 PLC-5/20 PLC-5/30 PLC-5/40 PLC-5/40L PLC-5/60 PLC-5/60L	Channel 0	RS232C	Setting	Your owner cable
CompactLogix	1769-L20 1769-L30 1769-L31 1769-L32E 1769-L35E	Channel 0 Channel 1	RS232C	Setting	Your owner cable
ControlLogix	1756-L61	CPU Direct	RS232C	Setting	Your owner cable

Ethernet System Communication

Series	CPU	Link Module	Connect Type	Parameter	Cable
MicroLogix	MicroLogix 1100 MicroLogix 1400	CPU Direct (channel 1)	Ethernet	Setting	Your owner cable
	MicroLogix 1000 MicroLogix 1100 MicroLogix 1200 MicroLogix 1500	1761-NET-ENI			
SLC500	SLC5/05	CPU Direct (channel 1)			
	SLC5/03 SLC5/04 SLC5/05	1761-NET-ENI			
PLC-5	ALL CPUs that support the link I/F on the right	1761-NET-ENI			

Serial Communication Setting

[MicroLogix/ PLC-5 RS232 communication](#)

HMI Attribute

HMI	Task Bar	HMI Extend Attribute	Historic Event
Print Setting	Serial Port 0 Setting	Serial Port 1 Setting	
Type	RS232	PLC Communication Time Out	3
Baud Rate	19200	Protocol Time Out 1(ms)	3
Data Bit	8	Protocol Time Out 2(ms)	3
Parity	none	Max interval of block pack(WORDS)	16
Stop Bit	1	Max interval of block pack(BITS)	32
Slave No.	1	Max block package size(WORDS)	64
		Max block package size(BITS)	64
Use Default Setting			
		OK	Cancel

SLC500 RS232 communication

HMI Attribute

HMI	Task Bar	HMI Extend Attribute	Historic Event
Print Setting	Serial Port 0 Setting	Serial Port 1 Setting	
Type	RS232	PLC Communication Time Out	3
Baud Rate	9600	Protocol Time Out 1(ms)	3
Data Bit	8	Protocol Time Out 2(ms)	3
Parity	none	Max interval of block pack(WORDS)	16
Stop Bit	1	Max interval of block pack(BITS)	32
Slave No.	1	Max block package size(WORDS)	64
		Max block package size(BITS)	64
Use Default Setting			
		OK	Cancel

CompactLogix/ControlLogix RS232 communication

HMI Attribute

HMI	Task Bar	HMI Extend Attribute	Historic Event
Print Setting	Serial Port 0 Setting	Serial Port 1 Setting	
Type	RS232	PLC Communication Time Out	6
Baud Rate	19200	Protocol Time Out 1(ms)	100
Data Bit	8	Protocol Time Out 2(ms)	3
Parity	none	Max interval of block pack(WORDS)	16
Stop Bit	1	Max interval of block pack(BITS)	128
Slave No.	1	Max block package size(WORDS)	64
		Max block package size(BITS)	256
Use Default Setting			
		OK	Cancel

PLC Software Setting

a. RSLogix500 software setting

Note: Driver: DF1 Full Duplex; Error Detection: CRC.

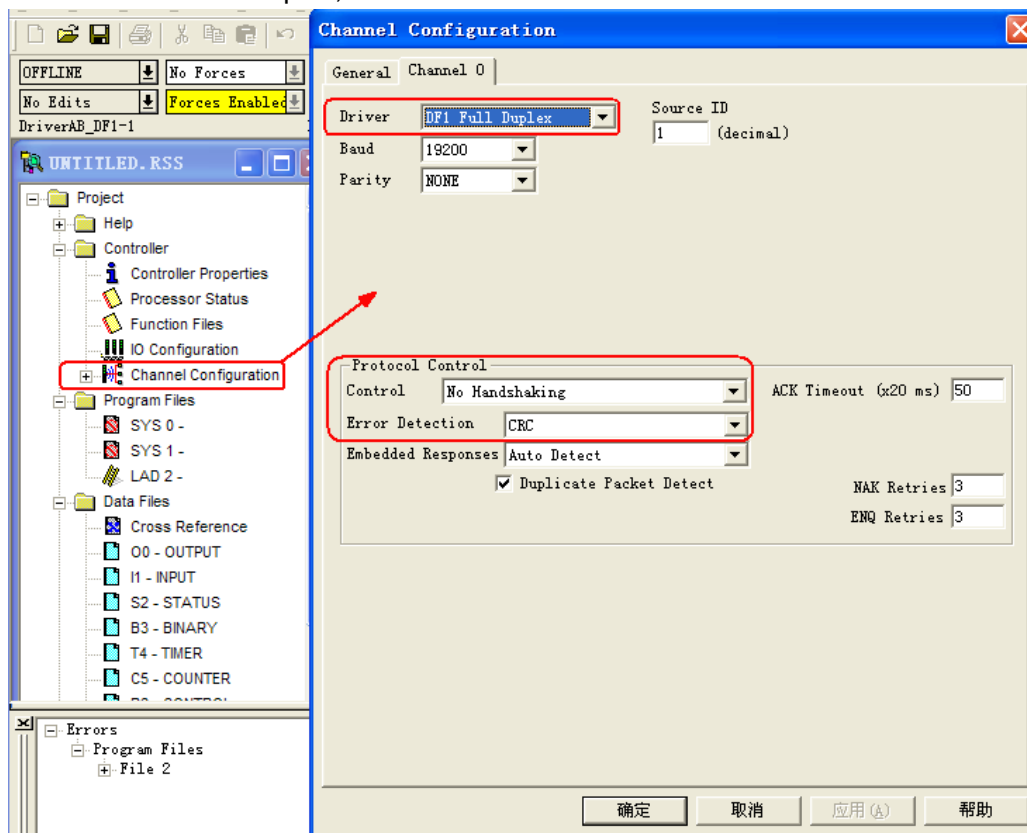

b. RSLogix5000 software setting

Note: Protocol: DF1 Point to Point; Error Detection: CRC; Enable Duplicate Detection: Disabled.

(1) Set the communication parameters: Controller properties

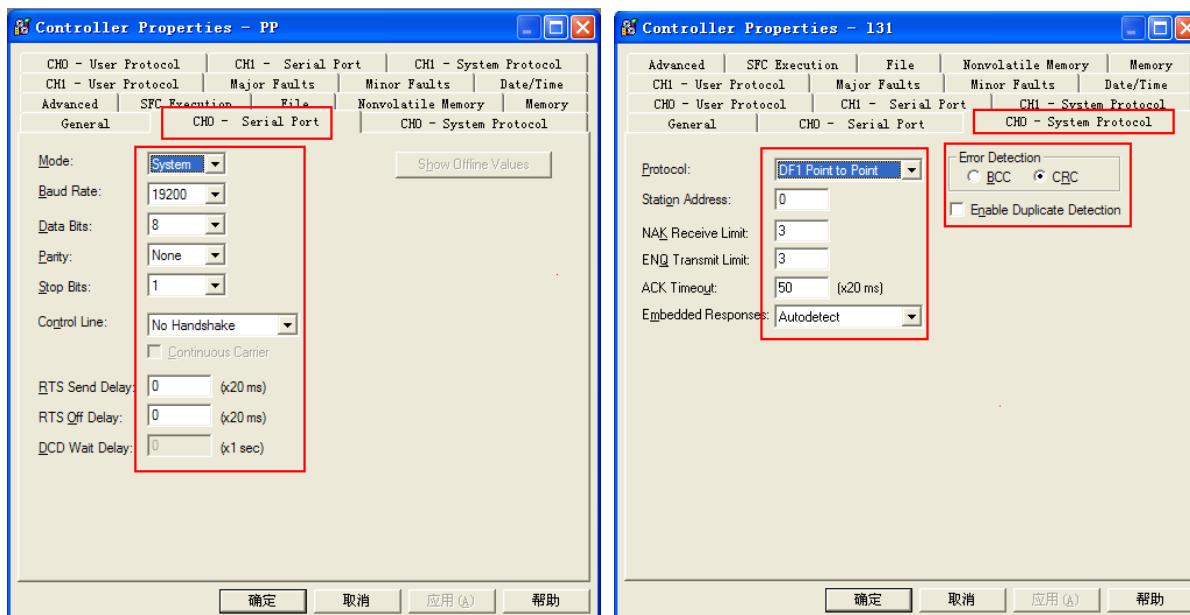

Note: Define the new device in the RSLogix5000 before using the register in the HMI.

(2) **Define Tags and Data type:** select “controller tags” right-click—>”edit tags”, set up Tags:

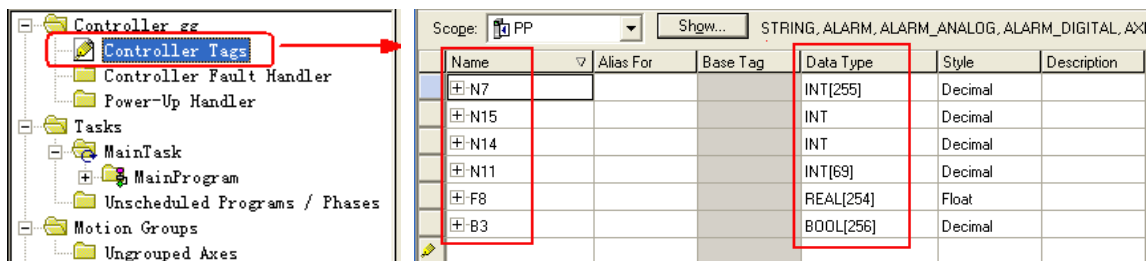

Note: When the Data Type isn't defined data array, only one address is available to use; how to define the Tag Number, you can refer to the RSLogix5000 manual.

(3) **Assign the Tag Name created by RSLogix5000 to the optional File Name:** select “logic”--->”map PLC/SLC messages”. (Note: the state of program software change to offline)

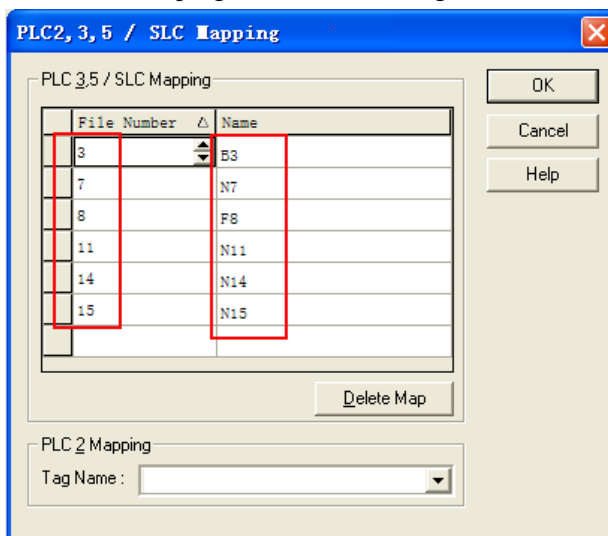

Note: You can not assign different Tag Names to the same File Number.

Ethernet Communication Setting

HMI

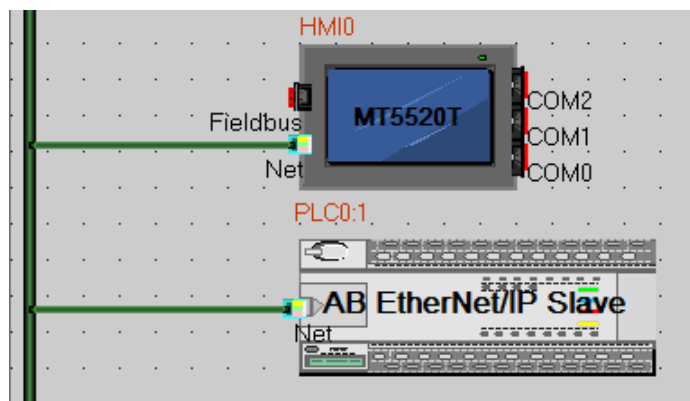

Network configuration

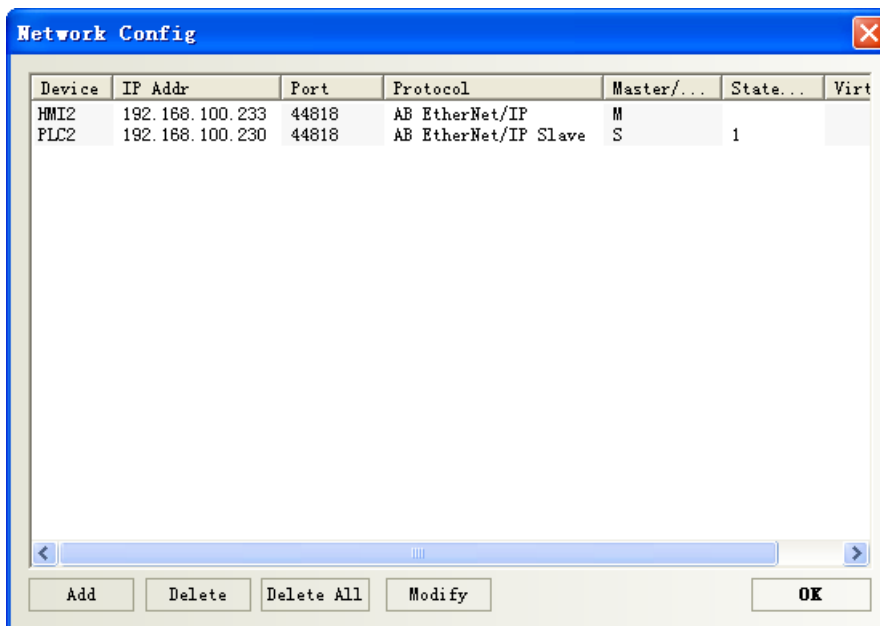

PLC configuration

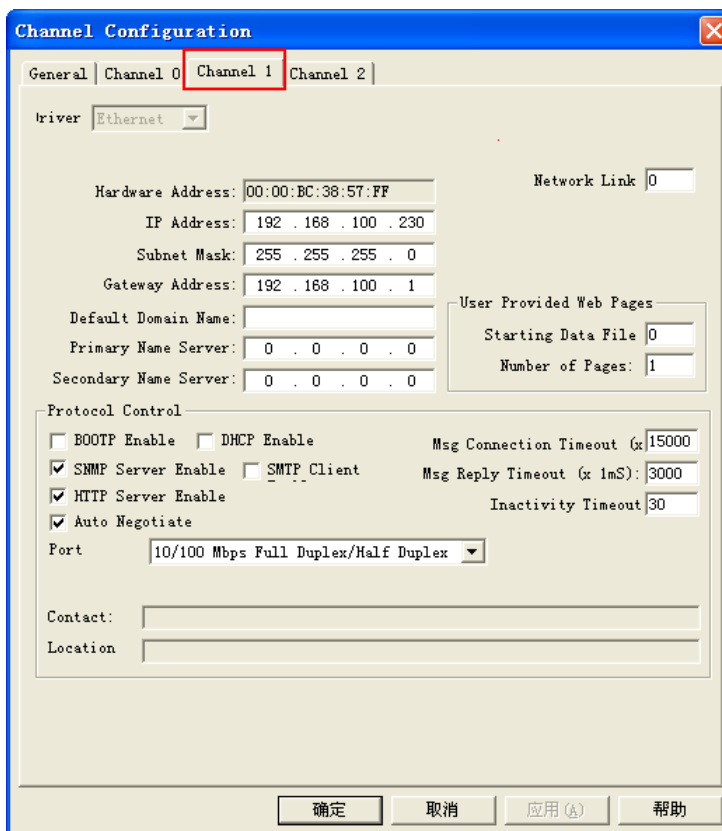

Supported Device

MicroLogix 1200

Device	Bit Address	Word Address	Format	Notes
Bit data file	B10: 0.0-254.15	-----	DDD.DD	
Bit data file	B3: 0.0-254.15	-----	DDD.DD	

Output data file	O0: 0.0-0.63	-----	DD.DD	
Input data file	I1: 0.0-0.63	-----	DD.DD	
Integer data file	-----	N15: 0	D	
Integer data file	-----	N14: 0	D	
Integer data file	-----	N11: 0-68	DD	
Integer data file	-----	N7: 0-254	DDD	
Floating point data file	-----	F8: 0-253	DDD	
Counter Accumulator Value	-----	C5PV: 0	D	
Counter Preset Value	-----	C5SV: 0	D	
Timer Accumulator Value	-----	T4PV: 0-35	DD	
Timer Preset Value	-----	T4SV: 0-35	DD	

Note: I1 address: 0/11, please input 0.11 in the ev5000; other register bits address are the same as I register.

Compactlogix L31

Device	Bit Address	Word Address	Format
Integer data file bit level	N_INT000000.00~254254.15	-----	FFFDDD.DD
Bit data file	B_BOOL000000~254991	-----	FFFDDD
Floating point data file	-----	REAL000000~254254	FFFDDD
Integer data file	-----	INT000000~254254	FFFDDD

Note: 1. FFF: file number; DDD: variable address. The correct format example as follow: file number112, variable address 87.12, format is 112087.12. Variable less than three address the need to fill the former 0.

2. Users can define the File Number.

AB EtherNet/IP Slave protocol

Device	Bit Address	Word Address	Format	Notes
Bit data file	B13: 0.0-255.15	-----	DDD.DD	
Bit data file	B12: 0.0-255.15	-----	DDD.DD	
Bit data file	B11: 0.0-255.15	-----	DDD.DD	
Bit data file	B10: 0.0-255.15	-----	DDD.DD	
Bit data file	B3: 0.0-255.15	-----	DDD.DD	
Bit data file	Bf:n: 0.0-255255.15	-----	FFFDDD.DD	*1
Output bit data file	O0: 0.0-255.15	-----	DD.DD	
Input bit data file	I1: 0.0-255.15	-----	DD.DD	
Output data file	-----	OW0: 0-255	DDD	
Input data file	-----	IW1: 0-255	DDD	
Integer data file	-----	N15: 0-255	DDD	
Integer data file	-----	N14: 0-255	DDD	
Integer data file	-----	N13: 0-255	DDD	
Integer data file	-----	N12: 0-255	DDD	

Integer data file	-----	N11: 0-255	DDD	
Integer data file	-----	N10: 0-255	DDD	
Integer data file	-----	N7: 0-255	DDD	
Integer data file	-----	Nf:n: 0-255255	FFFDDD	*1
Floating point data file	-----	F8: 0-255	DDD	
Floating point data file	-----	Ff:n: 0-255255	FFFDDD	*1
Counter Accumulator Value	-----	C5PV: 0-255	DDD	
Counter Preset Value	-----	C5SV: 0-255	DDD	
Timer Accumulator Value	-----	T4PV: 0-255	DDD	
Timer Preset Value	-----	T4SV: 0-255	DDD	

Note: 1. FFF: the file number; DDD: the variable address. The correct format example as follow: Bf:n 113087.12, file number 113, variable address 87.12; Ff:n 9002, file number 9, variable address 2. Variable is less than three addresses, the need to fill the former 0.

2. Users can define the File Number.

Cable Diagram

MicroLogix 1200 RS232 cable diagram

1. Cable made by AB Corporation

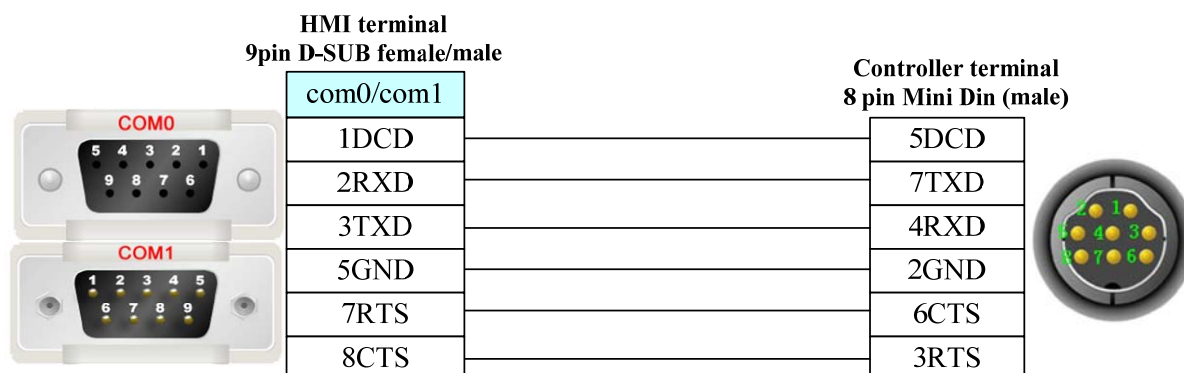

2. Communication module AIC+ (Part No. 1761-NET-AIC) RS232

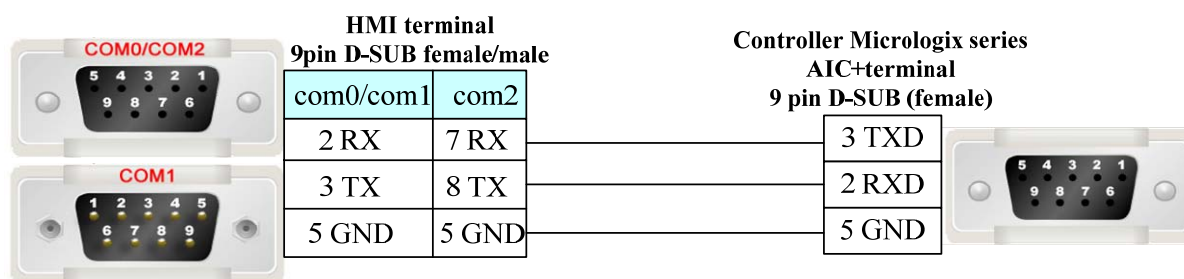

SLC 5/03 RS232 cable diagram

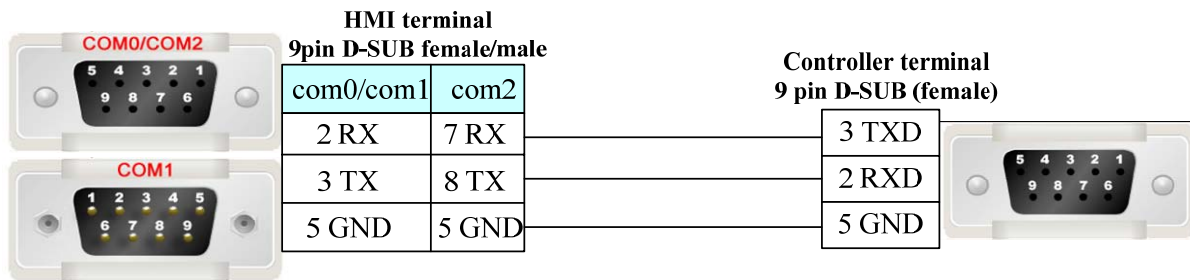

PLC-5 RS232 cable diagram

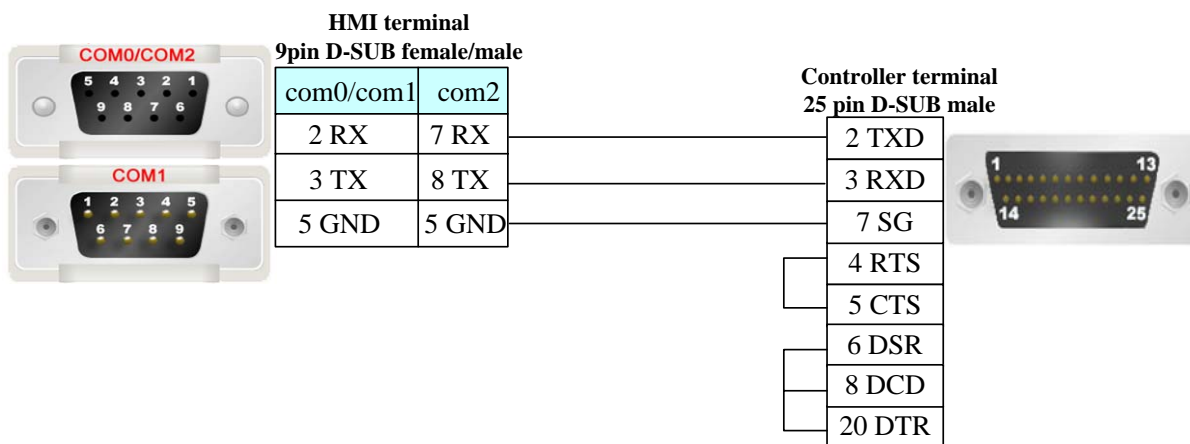

CompactLogix/ ControlLogix RS232 cable diagram

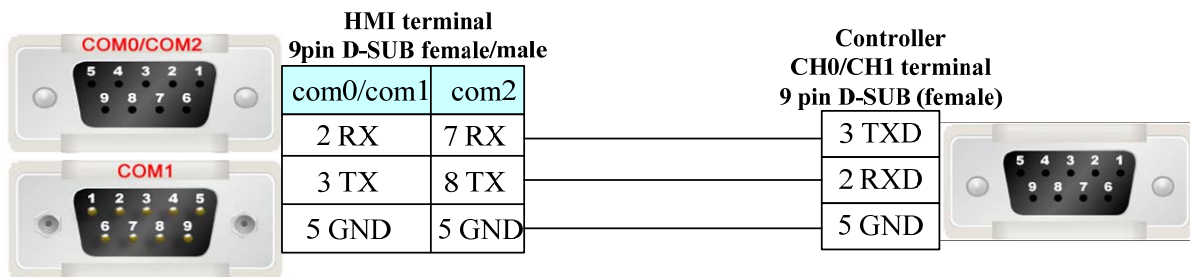

EtherNet cable

Connecting PC and HMI use cross-ruling; communicating with hub or switch use Cross-over cable or cross-ruling.

a. cross-ruling cable diagram:

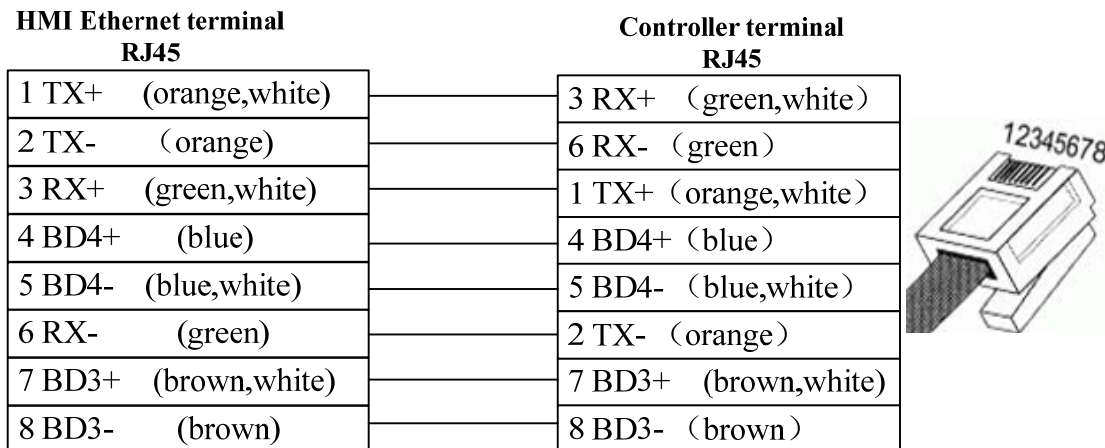

b. cross-over cable cable diagram:

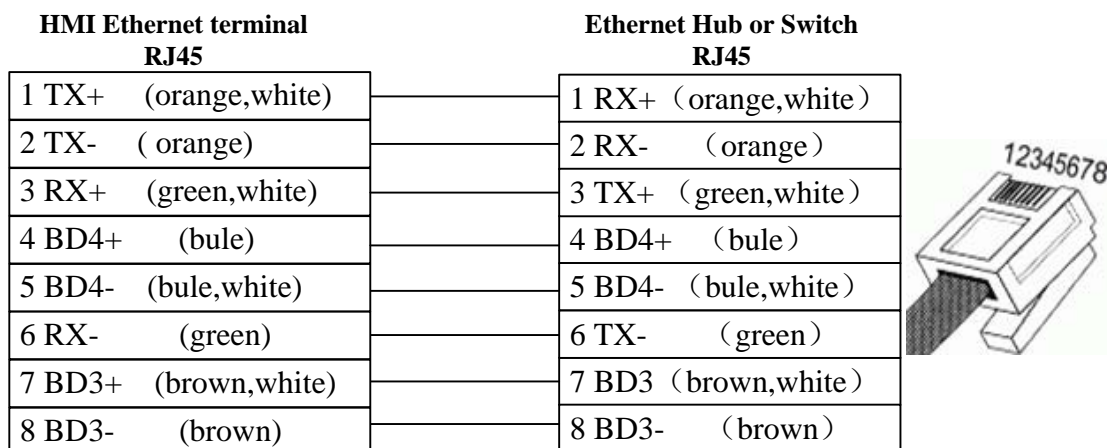

ACS-Tech80 Motion Controller

Serial Communication

Series	CPU	Link Module	Driver
SA2103	SB214SA	RS232 on the CPU unit	ACS-Tech80

System configuration

Series	CPU	Link Module	COM Type	Parameter	Cable
SA2103	SB214SA	RS232 on the CPU unit	RS232	Setting	Your owner cable

Communication Setting

RS232 communication

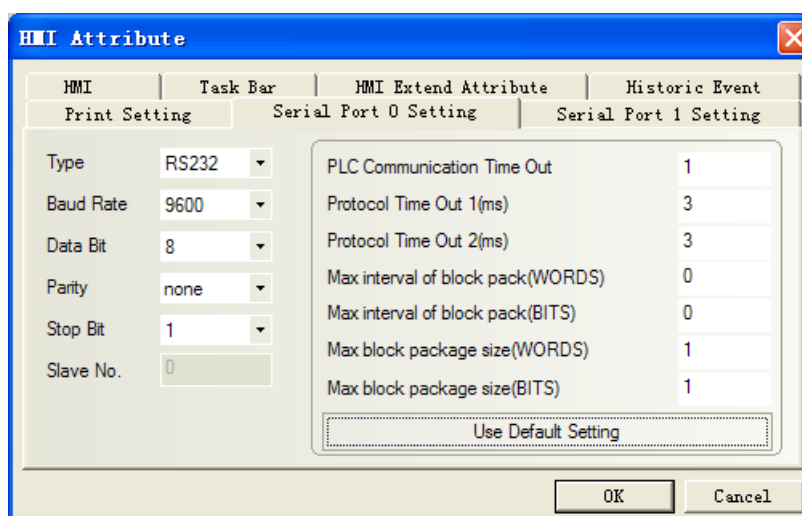

Supported Device

Device	Bit Address	Word Address	Format	Notes
Linear Deceleration (LD)	-----	LD 0~3	D	R/W
Linear Acceleration(LA)	-----	LA 0~3	D	R/W
Linear Velocity(LV)	-----	LV 0~3	D	R/W
Next trgt Abs Pos(AP)	-----	AP 0~3	D	R/W
Next Motion Mode(MM)	-----	MM 0~3	D	R/W
Functions Avail.(FA.1)	-----	FA.1 0~3	D	Read Only
Array Offset(AO)	-----	AO 0~3	D	R/W
Array's Upper Index(UI)	-----	UI 0~3	D	R/W
Array's Low Index(LI)	-----	LI 0~3	D	R/W
Path Gen.mode(PG)	-----	PG 0~3	D	R/W
Motor enabled(MO)	MO 0~3	-----	D	Write Only
CLEAR	CLEAR 0	-----	D	Write Only Write Only Write Only
RESET	RESET 0	-----	D	
B	B 0~3	-----	D	

Note: R: Readable, W: Writable.

Register instructions:

1.LD、LA、LV、AP、MM、FA.1、AO、UI、LI、PG

Main address: Axis parameter number (X、Y、Z、T)

2.MO、B (Operating instructions)

Main address: Axis parameter number (X、Y、Z、T)

3.CLEAR、RESET (Operating instructions)

Cable Diagram

RS232 communication cable

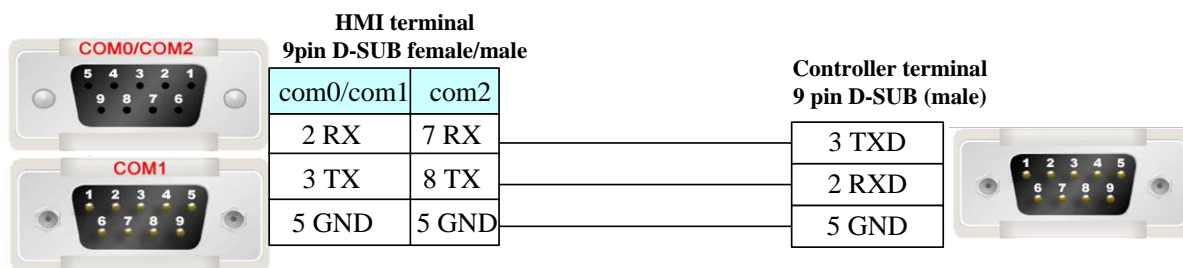

ADAM

Serial Communication

Series	CPU	Link Module	Driver
ADAM	ADAM-4017	RS485 on the CPU unit	ADAM-4017
	ADMA-4015	RS485 on the CPU unit	ADMA-4015

System configuration

Series	CPU	Link Module	COMM Type	Parameter	Cable
ADAM	ADAM-4017	RS485on the CPU unit	RS485	Setting	Your owner cable
	ADMA-4015	RS485 on the CPU unit	RS485	Setting	Your owner cable

Communication Setting

HMI

ADAM-4017 default communication: 9600, 8, none, 1; station: 255

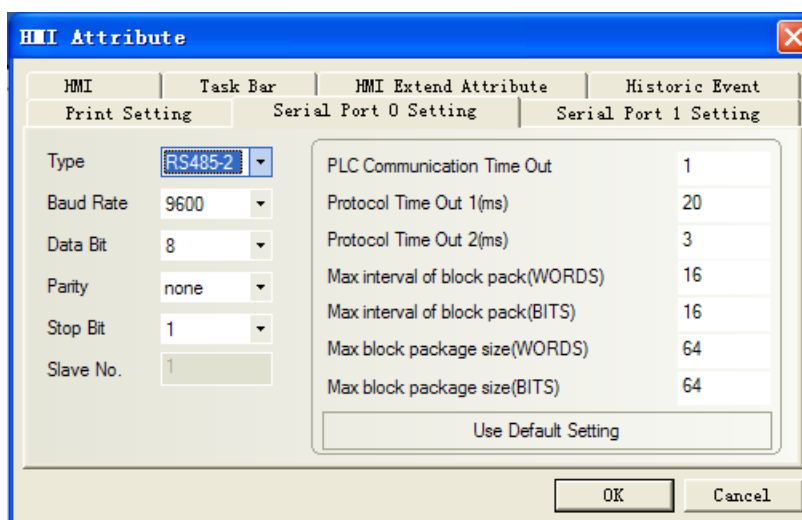

- Note:**
- To allow the “Check Code”;
 - Direct online simulation disables.

ADAM-4015 default communication: 9600, 8, none, 1; station: 1

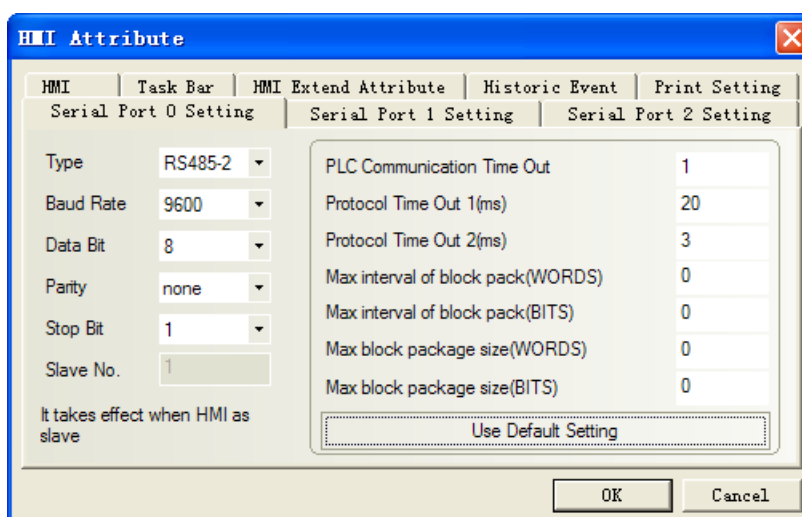

Note: PLC station must match with the ADAM-4015 configuration.

PLC

Connect “INIT” with “GND”, and reset the device, then set the communication of ADMA-4015.

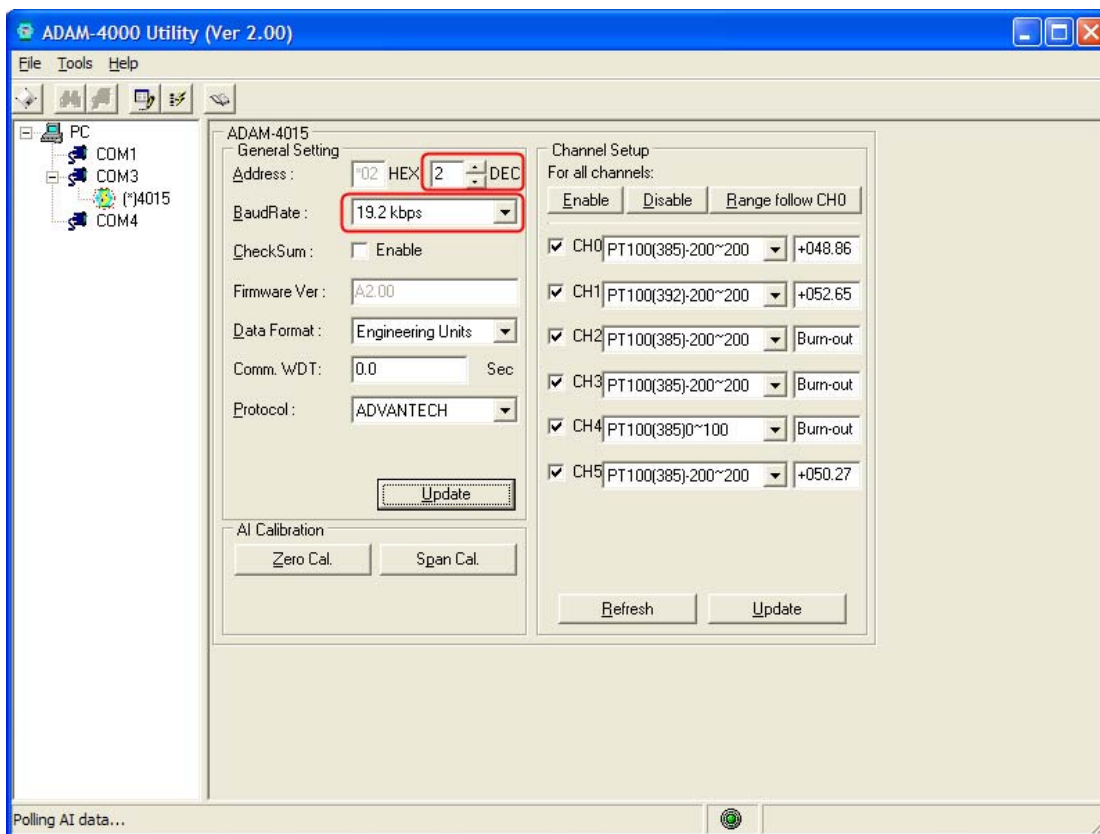

Set OK, then Update.

Supported Device

ADAM-4017

Device	Bit Address	Word Address	Format
Read Analog Input form Channel N	————	S_Channel 0-65535	DDDDD
Read Analog Input from all Channel	————	A_Channel 0-7	D
Configuration Status	————	Status 0-65535	DDDDD
Enable/disable Channels for Multiplexing	————	M_channel 0-65535	DDDDD
Read Channel Status	————	Channel_Status 0-65535	DDDDD
Read Version	————	Version 0-65535	DDDDD
Read Module Name	————	Name 0-65535	DDDDD

Note: Order code refer to the ADAM-4107 manual

- 1、“Data type” of S_Channel and A_Channel is signed integer. Decimal digits is 2 when the power supply is 500mv or 150mv, other conditions is 3.
- 2、“Data type” of other registers is HEXING
- 2、M_channel (\$AA5VV): At the same time allow multiplexing.
Enter the decimal value in the range of 0 to 255, mapping hexadecimal (00-FF)

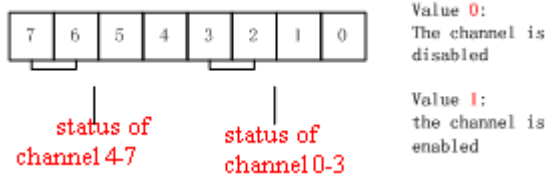

255 (FF): 0-7 channel show.

127 (7F): 0-6 channel show, 7 Channel does not show.

ADAM-4015

Device	Bit Address	Word Address	Format	Notes
Channel	-----	Channel 0-5	D	Floating

Note: Channel 0-5 data type is floating.

Cable Diagram

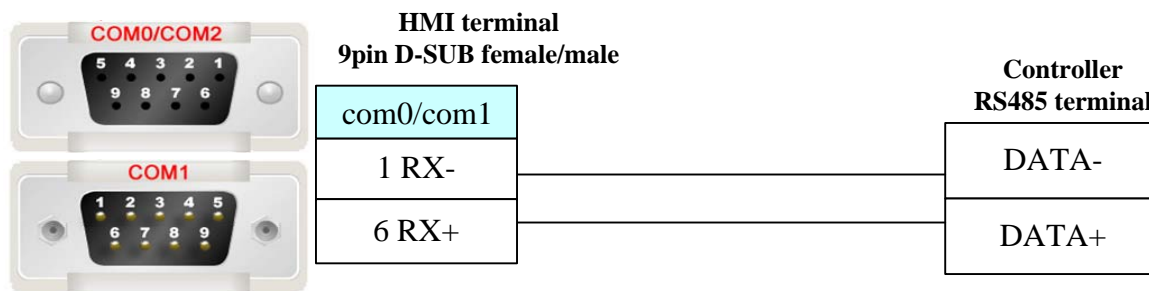

AysjNet

Serial Communication

Series	CPU	Link Module	Driver
Compressor Controller	KYK3-K	RS485 on port	AysjNet

System configuration

Series	CPU	Link Module	COMM Type	Parameter	Cable
Compressor Controller	KYK3-K	RS485 on port	RS485	Setting	Your owner cable

Communication Setting

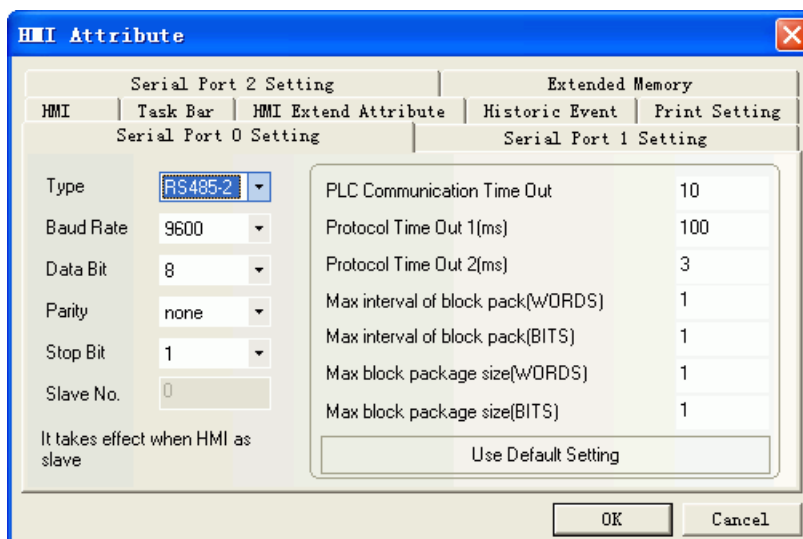

Supported Device

Device	Bit Address	Word Address	Format	Notes
control	CTL (0~5) &128&150	-----	DDD	Write only
set	-----	SET (0~51)&128	DDD	
state	-----	STATUS 0.0~17.2	DD.D	Read only

Cable Diagram

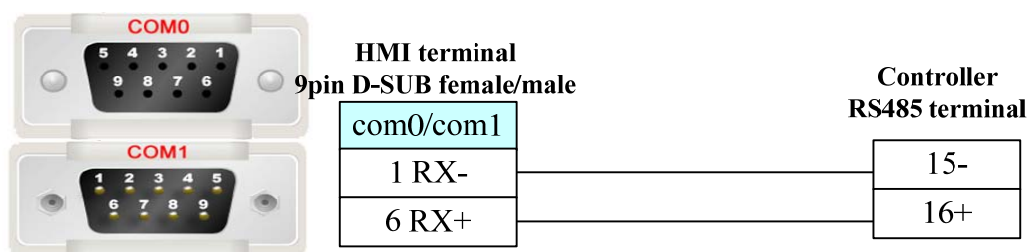

Baldor NextMove ES (Motion Controller)

Serial Communication

Series	CPU	Link Module	Driver
NextMove ES	NextMove ES	RS232 on the CPU unit	Baldor NextMove ES

System configuration

Series	CPU	Link Module	COMM Type	Parameter	Cable
NextMove ES	NextMove ES	RS232 on the CPU unit	RS232	Setting	Your owner cable

Communication Setting

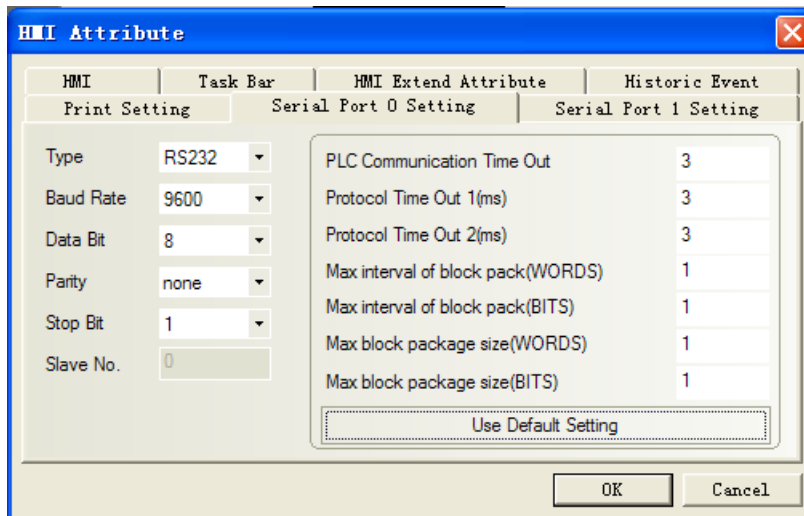

PLC software setting

Use the guide of the Workbench software

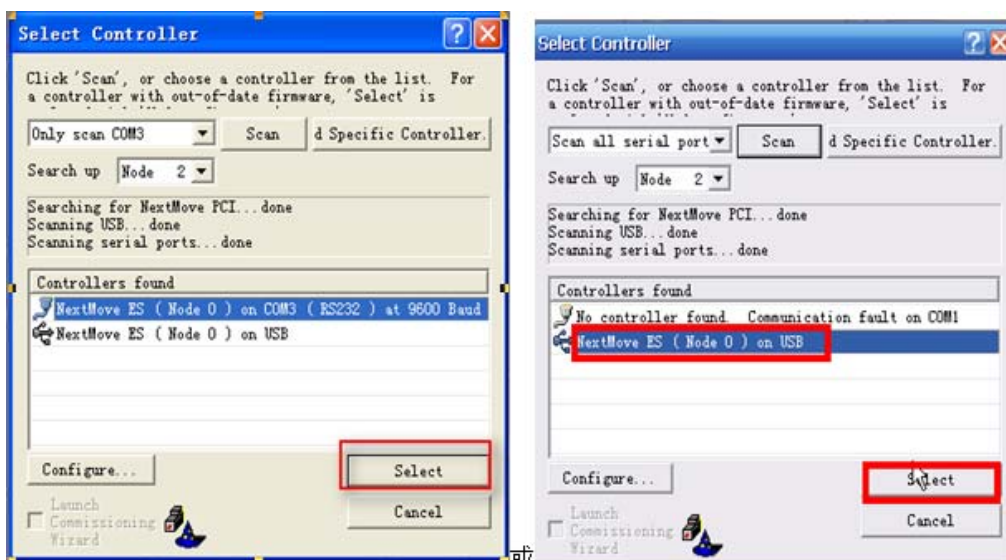
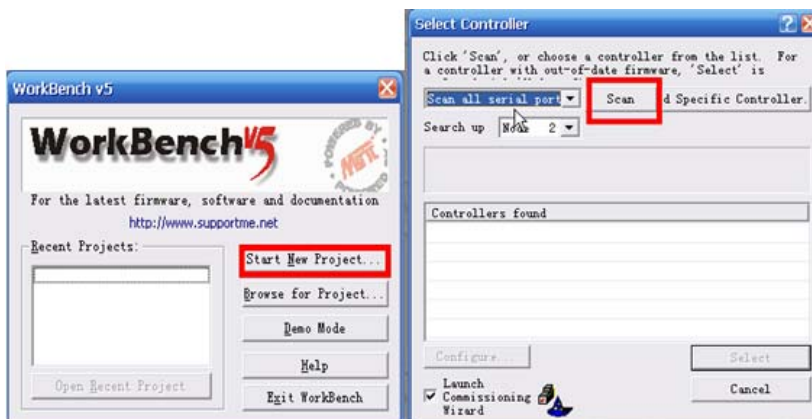

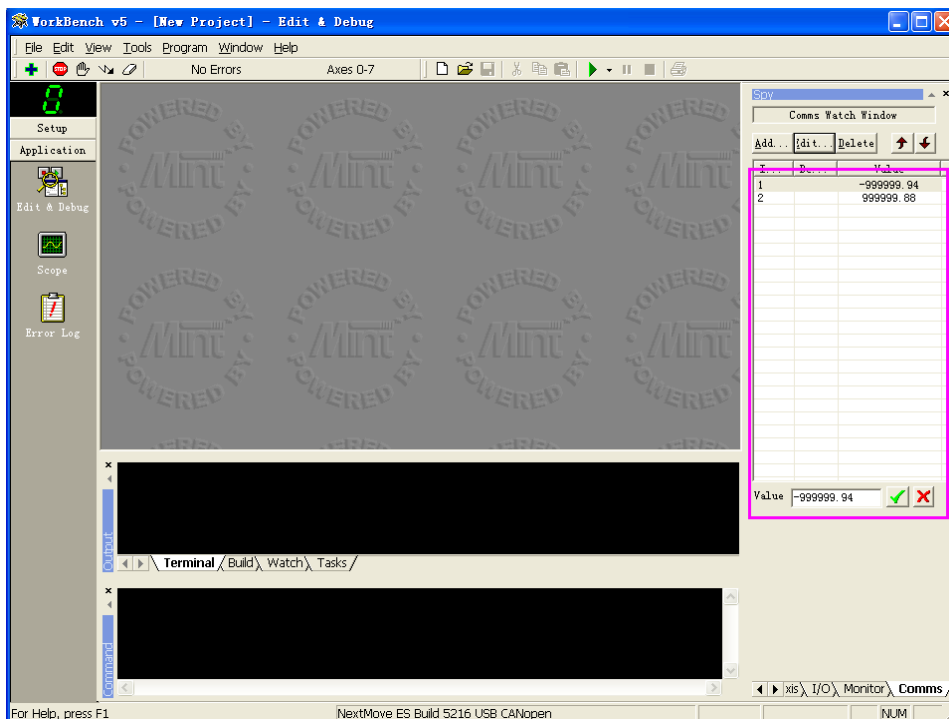

Supported Device

(Only data of comms can be monitored, some address greater than or equal to 100 are read only. Please pay attention to matching the controller software configuration.)

Device	Bit Address	Word Address (Parameter symbol)	Format	Notes
Float	-----	1-255	DDD	Float Data type

Cable Diagram

RS232 communication cable of HMI connecting to controller

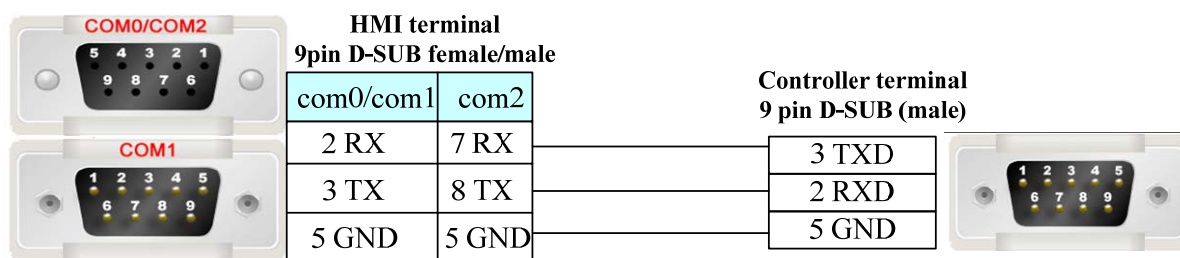

RS232 programming cable (Also can use USB, Power is +5v/±12v)

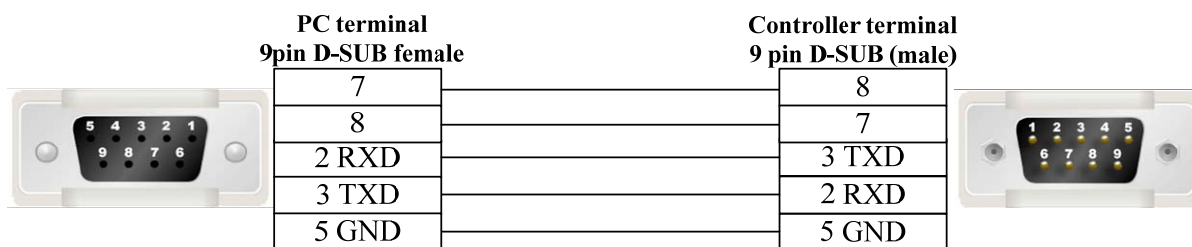

Barcode

Serial Communication

Series	CPU	Link Module	Driver
Barcode	3800LTP-12E	RS232	Barcode

System configuration

Series	CPU	Link Module	COMM Type	Parameter	Cable
Barcode	3800LTP-12E	RS232	RS232	Setting	Your owner cable

Communication Setting

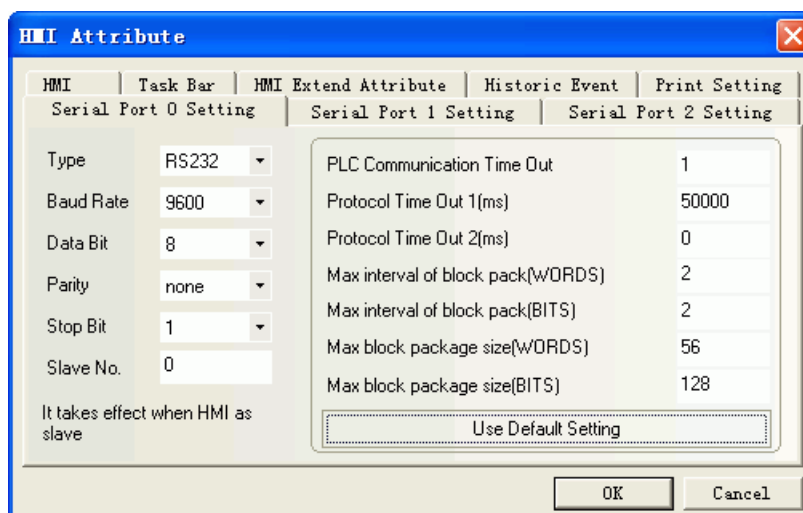

Supported Device

Device	Bit Address	Word Address	Format	Notes
Word	-----	LW 0-8999	DDDD	
Word	-----	LW 9000	DDDD	

- Note:**
1. LW0-8999: the character after scanning, text and note book parts can display it.
 2. LW9000: the state of barcode is received or not. LW9000=1 means the data is received.

Cable Diagram

Connect the scanner and the COM port of HMI directly.

Baumuller

Serial Communication

Series	CPU	Link Module	Driver
Baumuller	BM4413-ST0-02200-03	RS422 on the CPU unit	Baumuller

System configuration

Series	CPU	Link Module	COMM Type	Parameter	Cable
Baumuller	BM4413-ST0-02200-03	RS422 on the CPU unit	RS485	Setting	Your owner cable

Communication Setting

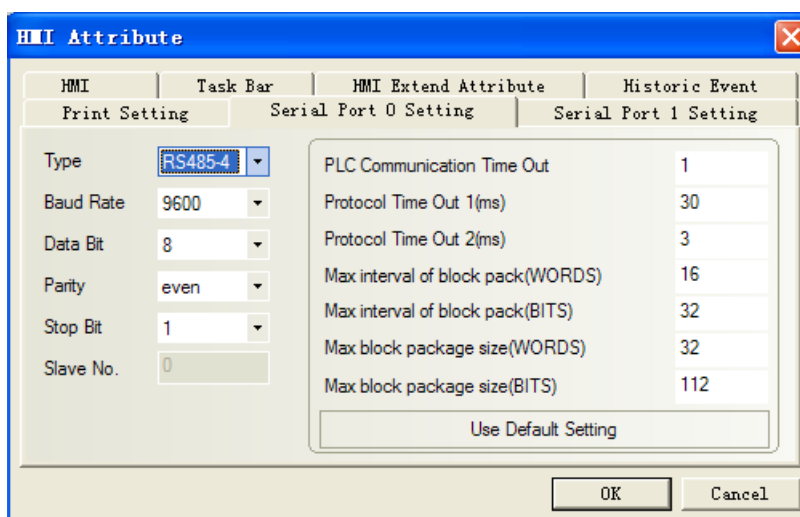

Supported Device

Device	Bit Address	Word Address	Format	Notes
Bit type	DB_BIT0. 00-255. F	-----	DDD.H	
Word type	-----	DB0-255	DDD	

Example: DB2_BIT address please input 0.F in the EV5000 software.

DB2 address please input 11 in the EV5000 software.

Cable Diagram

RS485-4 communication cable

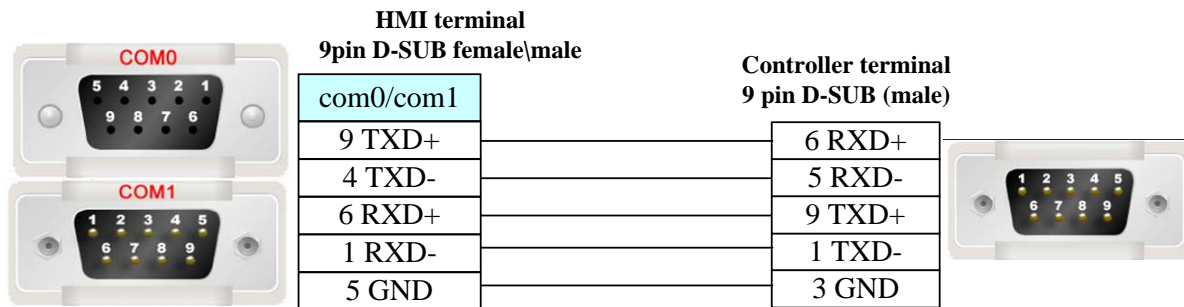

Bosch Rexroth KVFC+ (Frequency Converter)

Serial Communication

c	CPU	Link Module	Driver
KVFC+		RS485	Bosch Rexroth KVFC+

System configuration

Series	CPU	Link Module	COMM Type	Parameter	Cable
KVFC+		RS485 on the CPU unit	RS485	Setting	Your owner cable

Communication Setting

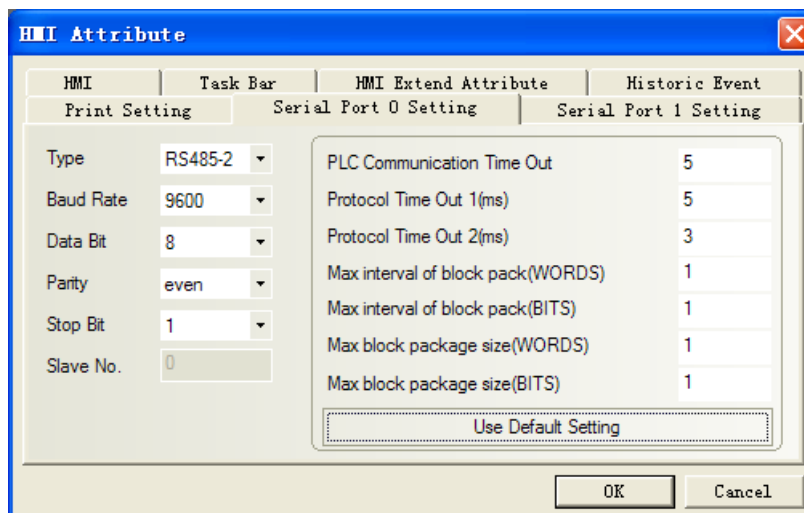

Supported Device

Device	Bit Address	Word Address	Format	Notes
Start/Stop	STW0~3	-----	D	STW0 open, start. STW0 close, stop.

				STW1 close, positive rotation. STW1 open, negative rotation. STW2 REV inching turning. STW3 FWD inching turning.
Set frequency	-----	HSW 0	D	
Basic Function Block	-----	B 0~41	DD	B16 acceleration time. B17 deceleration time.
Deviation alarm	-----	E 0~41	DD	
Programmable control function array	-----	P 0~37	DD	
High function array	-----	H 0~38	DD	
D array	-----	D 0~6	D	D0: output power. D2: running current.

Cable Diagram

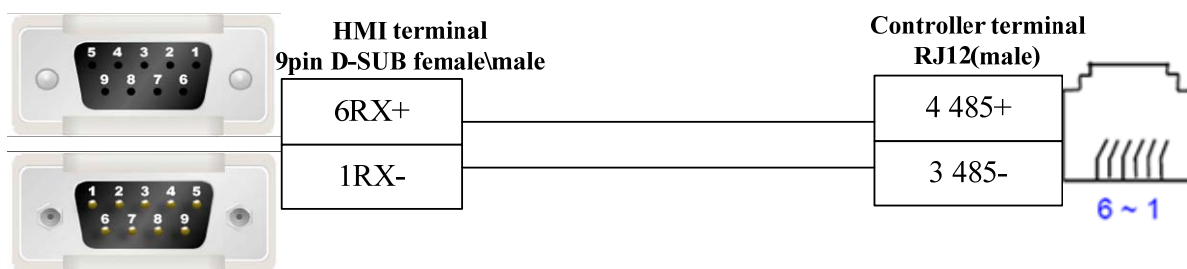

Bosch Rexroth

Serial Communication

Series	CPU	Link Module	Driver
PPC-R	PPC-R22.1 13VRS	RS232 on the CPU unit	Bosch Rexroth
		RS485 on the port	
L	L40	RS232 on the CPU unit	
	L20	RS232 on the CPU unit	

System configuration

Series	CPU	Link Module	COMM Type	Parameter	Cable
PPC-R	PPC-R22.1 13VRS	RS232 on the CPU unit	RS232C	Setting	Your owner cable
		RS485 on the port	RS485	Setting	Your owner cable
L	L40 L20	RS232 on the CPU unit	RS232C	Setting	Your owner cable

Communication Setting

PPC-R communication setting

RS232 communication: 19200, 8, even, 1; station number: 128

The screenshot shows the 'HMI Attribute' dialog box with the 'Serial Port 0 Setting' tab selected. The 'Type' is set to 'RS232'. The 'Baud Rate' is '19200', 'Data Bit' is '8', 'Parity' is 'even', 'Stop Bit' is '1', and 'Slave No.' is '0'. The 'PLC Communication Time Out' is '1', 'Protocol Time Out 1(ms)' is '30', and 'Protocol Time Out 2(ms)' is '0'. The 'Max interval of block pack(WORDS)' is '1', 'Max interval of block pack(BITS)' is '1', 'Max block package size(WORDS)' is '1', and 'Max block package size(BITS)' is '1'. There is a 'Use Default Setting' button and 'OK' and 'Cancel' buttons at the bottom.

Serial Port 0 Setting	Serial Port 1 Setting
PLC Communication Time Out	1
Protocol Time Out 1(ms)	30
Protocol Time Out 2(ms)	0
Max interval of block pack(WORDS)	1
Max interval of block pack(BITS)	1
Max block package size(WORDS)	1
Max block package size(BITS)	1

RS485 communication

The screenshot shows the 'HMI Attribute' dialog box with the 'Serial Port 0 Setting' tab selected. The 'Type' is set to 'RS485-2'. The 'Baud Rate' is '19200', 'Data Bit' is '8', 'Parity' is 'even', 'Stop Bit' is '1', and 'Slave No.' is '0'. The 'PLC Communication Time Out' is '1', 'Protocol Time Out 1(ms)' is '30', and 'Protocol Time Out 2(ms)' is '0'. The 'Max interval of block pack(WORDS)' is '1', 'Max interval of block pack(BITS)' is '1', 'Max block package size(WORDS)' is '1', and 'Max block package size(BITS)' is '1'. There is a 'Use Default Setting' button and 'OK' and 'Cancel' buttons at the bottom.

Serial Port 0 Setting	Serial Port 1 Setting
PLC Communication Time Out	1
Protocol Time Out 1(ms)	30
Protocol Time Out 2(ms)	0
Max interval of block pack(WORDS)	1
Max interval of block pack(BITS)	1
Max block package size(WORDS)	1
Max block package size(BITS)	1

Note: To communicate with the touch screen, declare variable firstly in the Rexroth software.

L40 communication settings

Default communication: 38400, 8, 1, none; Station No.: 2

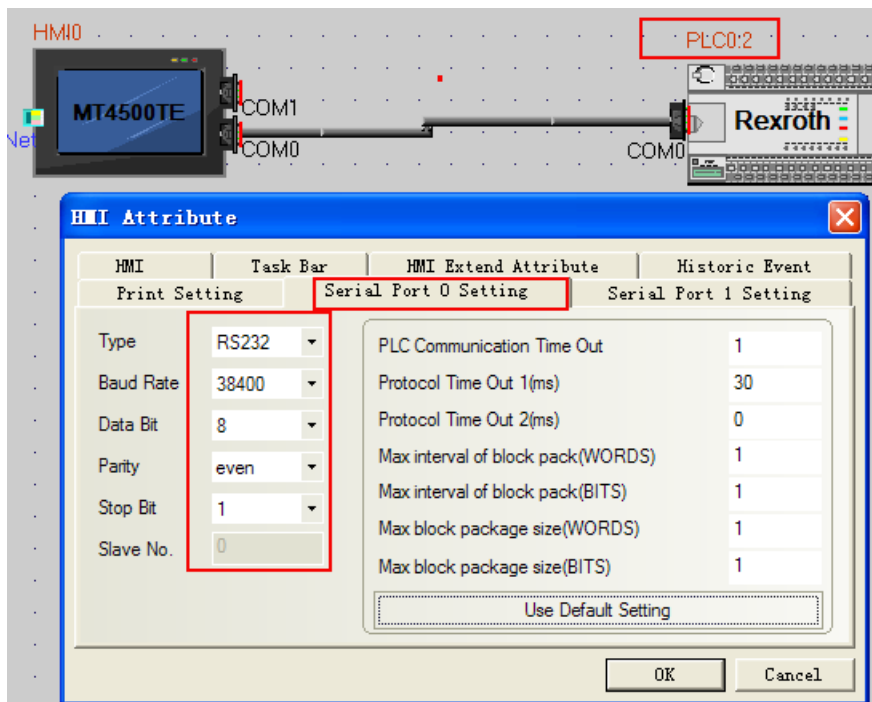

Note: To communicate with the touch screen, declare variable firstly in the Rexroth software.

L40 Hardware Settings

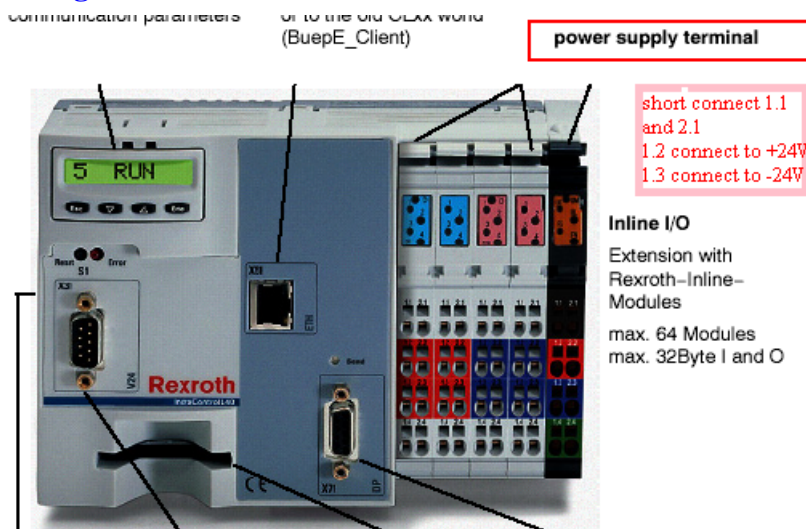

PLC Software Settings

PPC-R software setting

PLC connects with PC via crossover ethernet cable. If using cross-connection ethernet cable, you must add a HUB (we usually use a cross-connection line to access the Internet)

Hardware configuration:

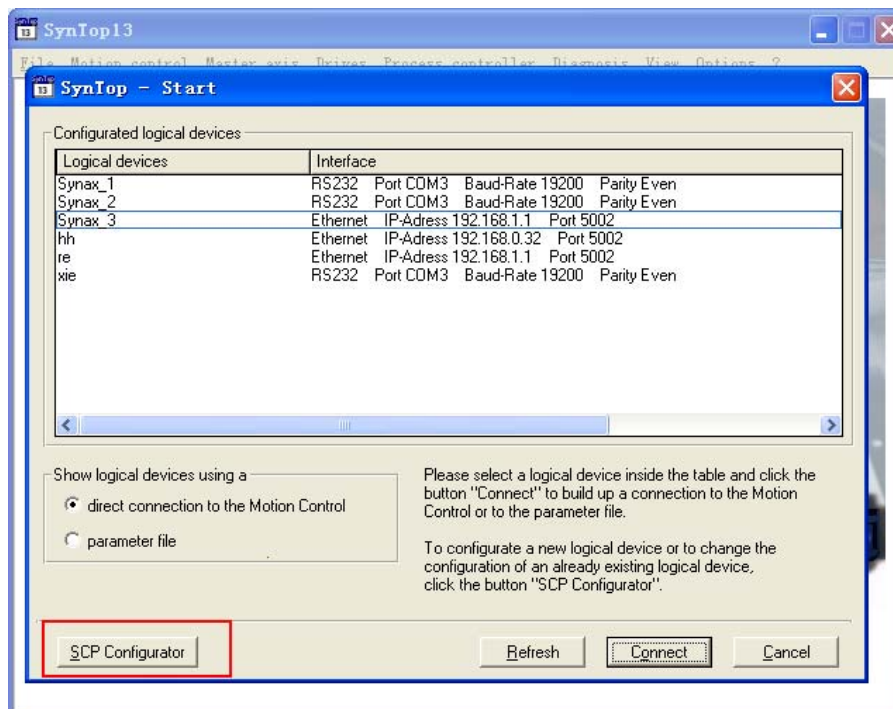

1. Click "scp configurator" ---> "scanning" or "add device" ---> "next", pay attention to the default controller IP: 192.168.1.1. And set IP 192.168.1.1 in the software (**PC and controller must be set up in the same segment**), ping IP address is OK, that configuration is successful. Save and close "scp configurator" ---> "refresh" to see logical devices created in configured logical devices", double-click to enter. All configurations will be successful.

2. Open "indralogic" ---> **online/communication parameter** ---> "new" and select "TCP/IP" to modify "value", set IP address the same as controller: 192.168.1.1

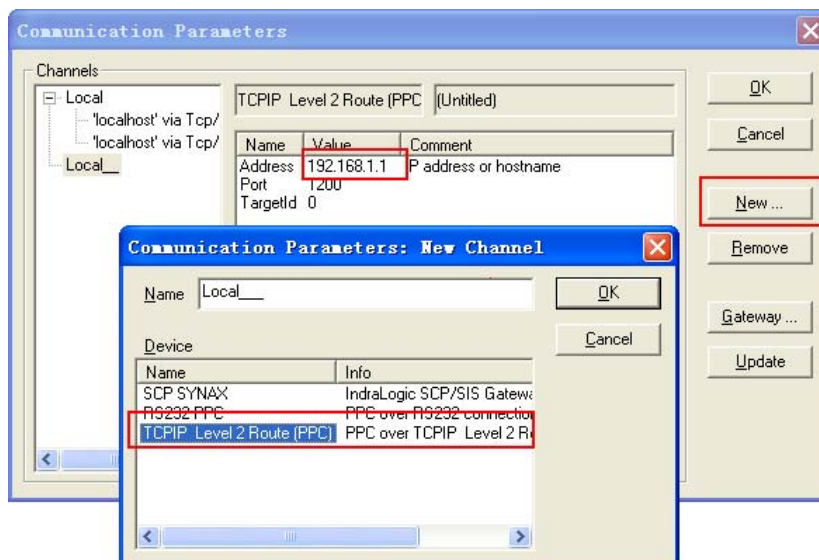

3. "Resource" ---> "Global variables" ---> declare variable in "HMI"

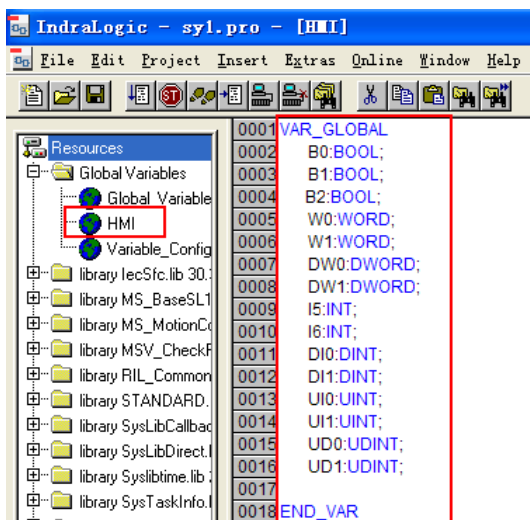

4. Click “online/login”

L40 software setting

- 1) The IndraLogic software connect with the Rexroth IndraControl L40 by ethernet cable (test: plc IP address: 192.168.100.103)

Open the IndraLogic software, create a new project:

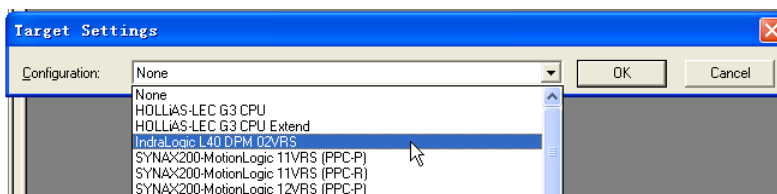

Click “OK” and pop-up the window as follows:

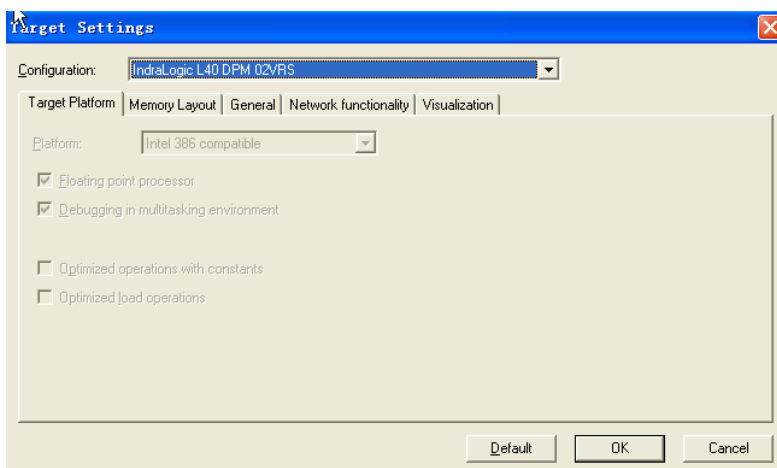

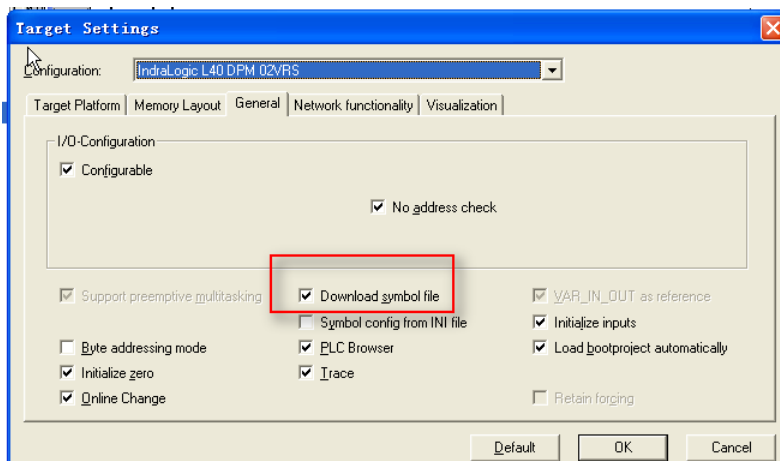

Note: Must select Download symbol file
Click “OK” and pop-up the window as follows:

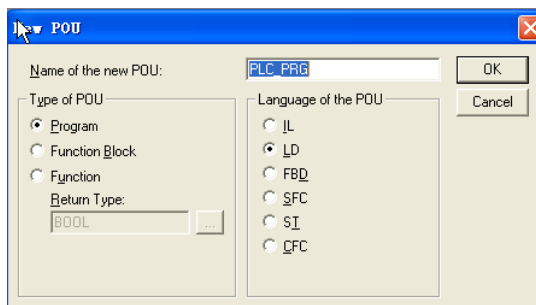

And then edit program:

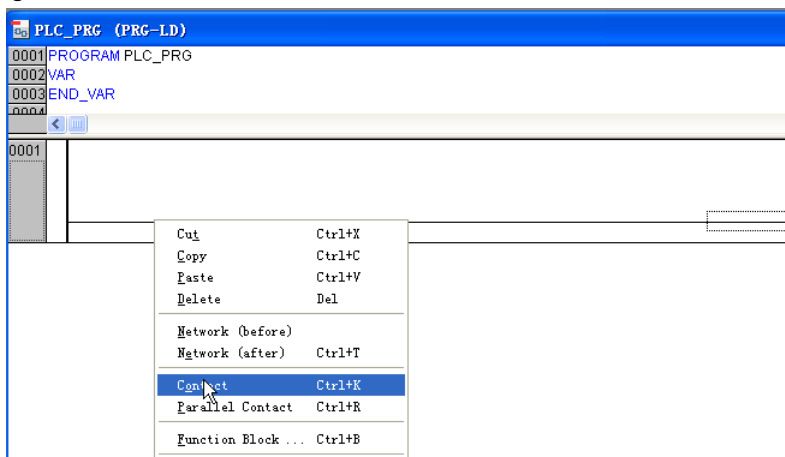

Input B0 and pop-up the dialog, configurations as follows, click “OK”:

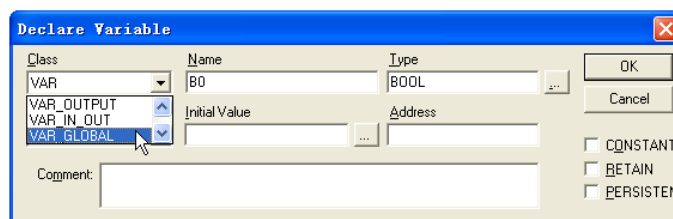

And set up coil:

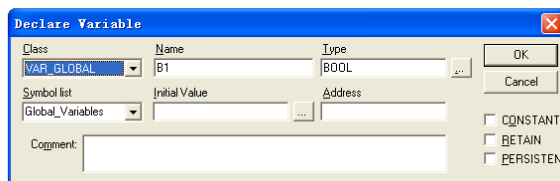
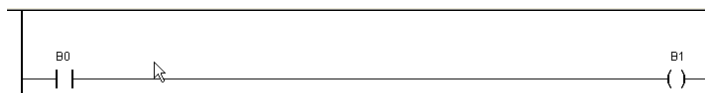

At the same time, you will find that there automatically generate two variables in the global variable:

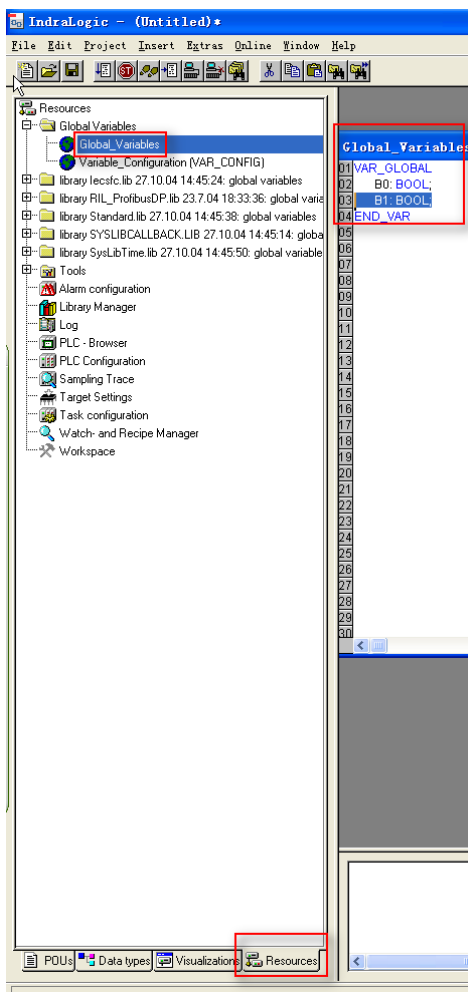

Then setting as follows:

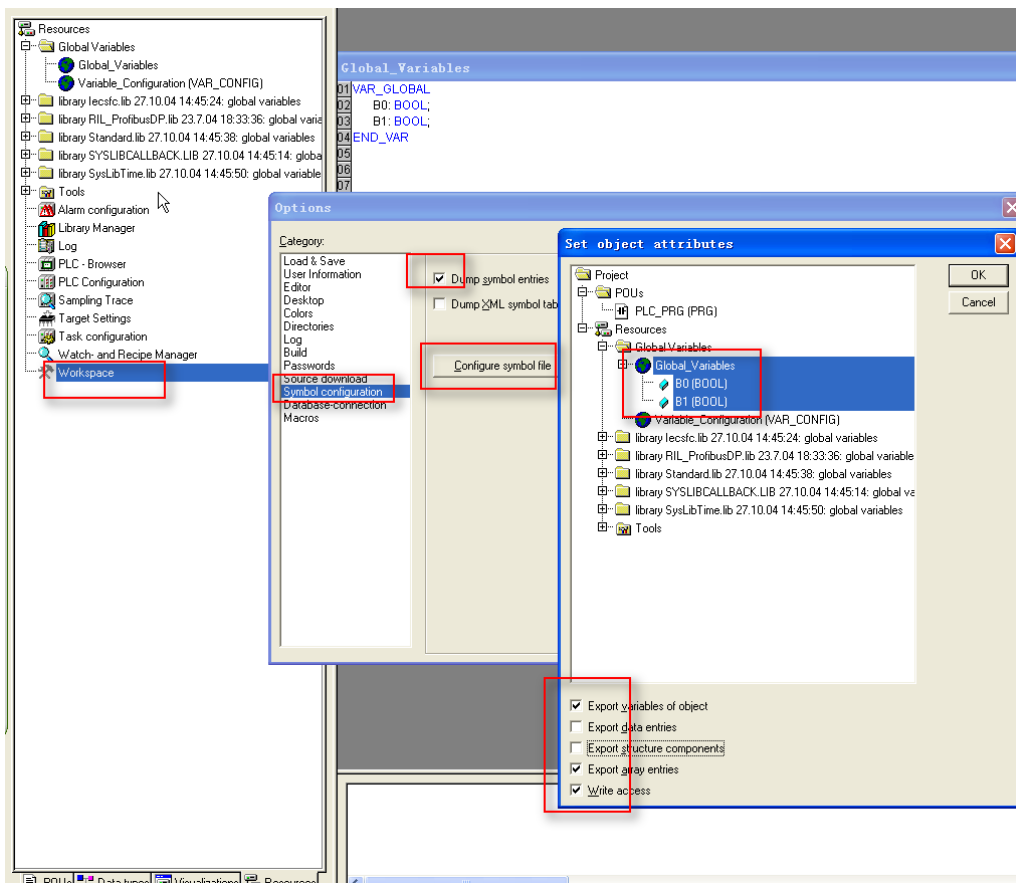

Setting communication parameter:

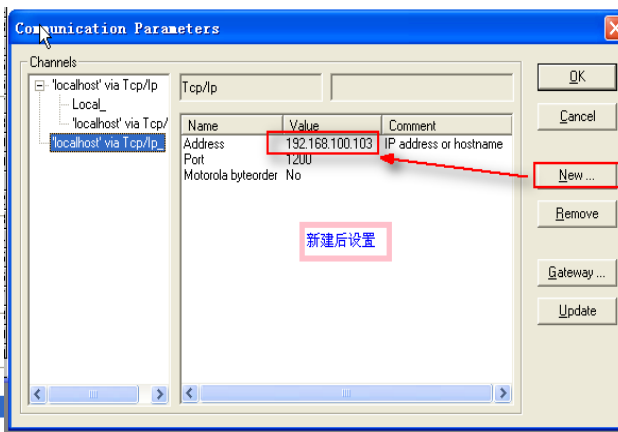

Then click "Login":

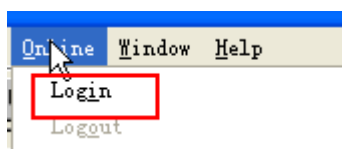

Communicating successfully, you can operate ("Online" menu to select "run" or others):

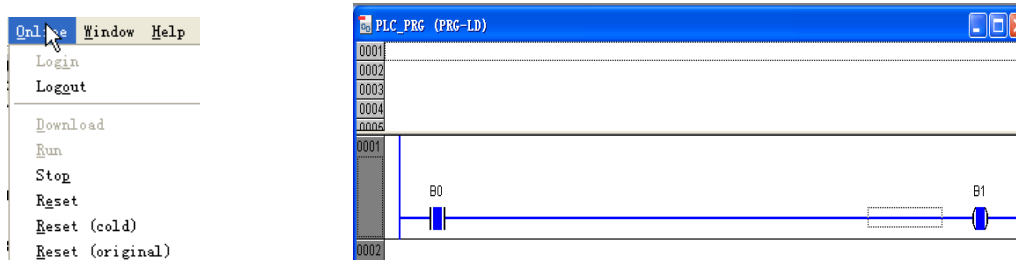

Note: The PLC panel must be set up, press "Enter", then press "△", until showed up "RS232", and then press "Enter" to enter "COM SERV" interfaces (not SERV, it must change to SERV)



In accordance with the above settings, the serial line access, EV5000 can be communicated with the Rexroth Controller L40 by serial port.

Supported Device

Device	Bit Address	Word Address	Format	Notes
BYTE	B0000-9999	-----	DDDD	
WORD	-----	W0-65535	DDDDD	
INT	-----	I0-65535	DDDDD	
UINT	-----	UI0-65535	DDDDD	
DWORD	-----	DW0-65535	DDDDD	
DINT	-----	DI0-65535	DDDDD	
UDINT	-----	UD0-65535	DDDDD	

Cable Diagram

PPC-R RS232 communication cable

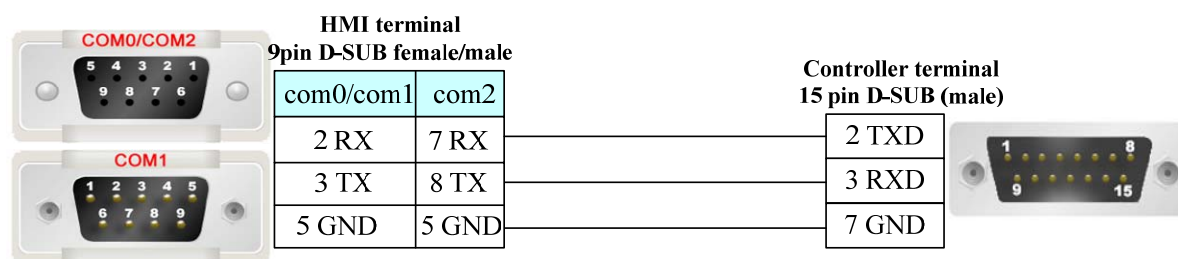

PPC-R RS485 communication cable

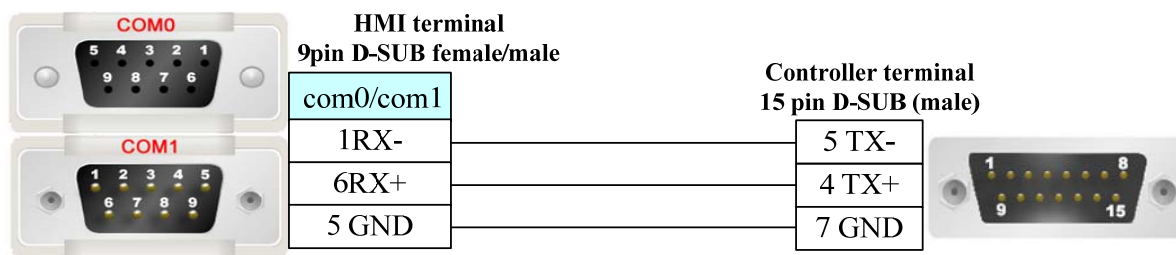

L40 communication cable

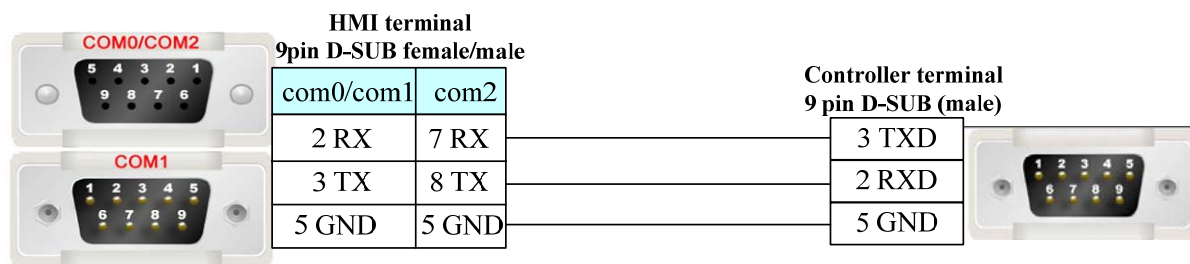

Bosch Rexroth Ethernet

Network communication (indirect online and direct online simulation disable)

Series	CPU	Link Module	Driver
IndraLogic	IndraLogic L40 DPM	ETH on the CPU unit	Bosch Rexroth Ethernet

System configuration

Series	CPU	Link Module	COMM Type	Parameter	Cable
IndraLogic	L40 DPM 02VRS	ETH on the CPU unit	ETH	Setting	Your owner cable

Communication Setting

Network communication

※Project construction

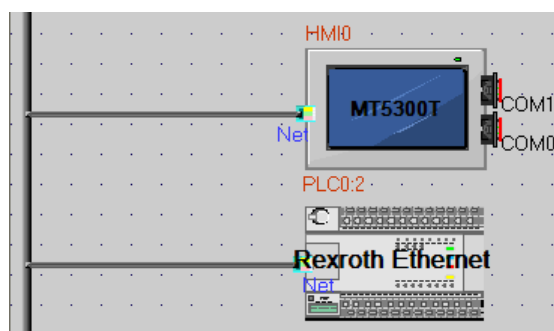

※HMI Attribute

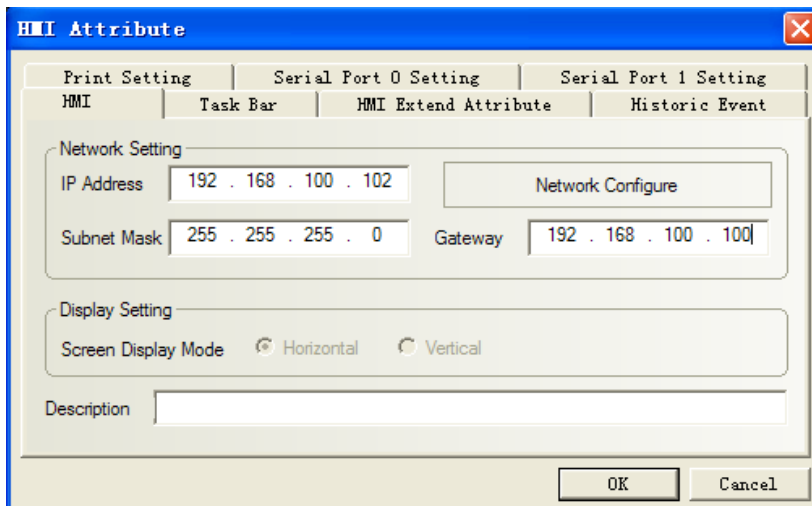

※PLC Attribute (station disable)

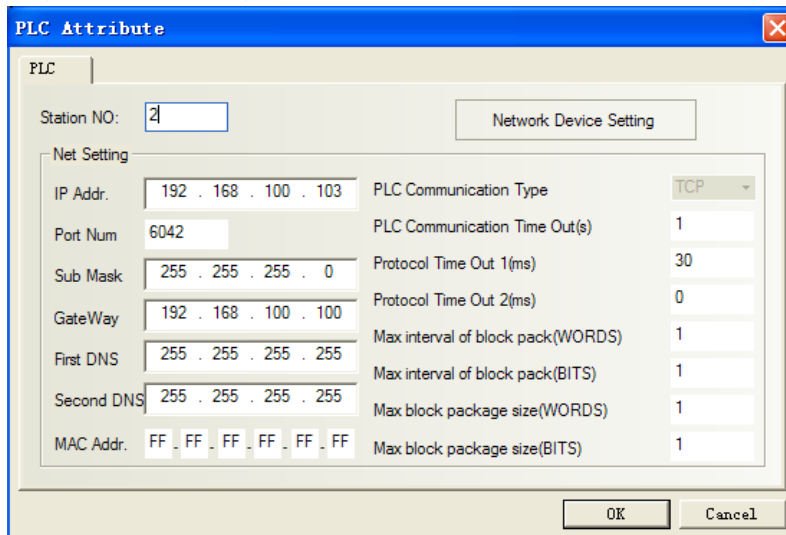

※Network configuration (Note: PLC port num. must be set 6042, HMI port num. is optional, default is 6042. In addition, the screen and plc must be set in the same network segment, the gateway of the screen is better to set with the actual use of the network gateway .)

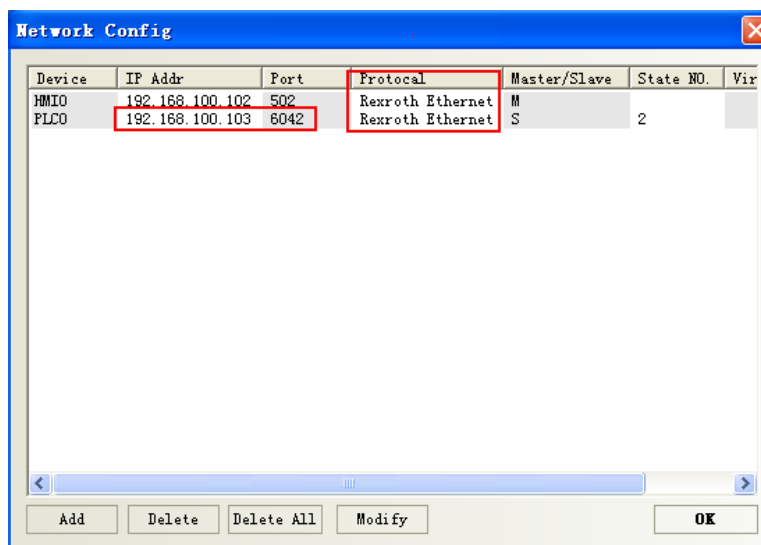

Note: To communicate with the touch screen, declare variable firstly in the Rexroth software.

PLC software setting

PLC connect with PC by crossover network cable, if using cross-connection network cable, you must add a HUB (we usually use a cross-connection line to access the Internet)

1. After L40 equipped with software driver successfully, to set as follows:

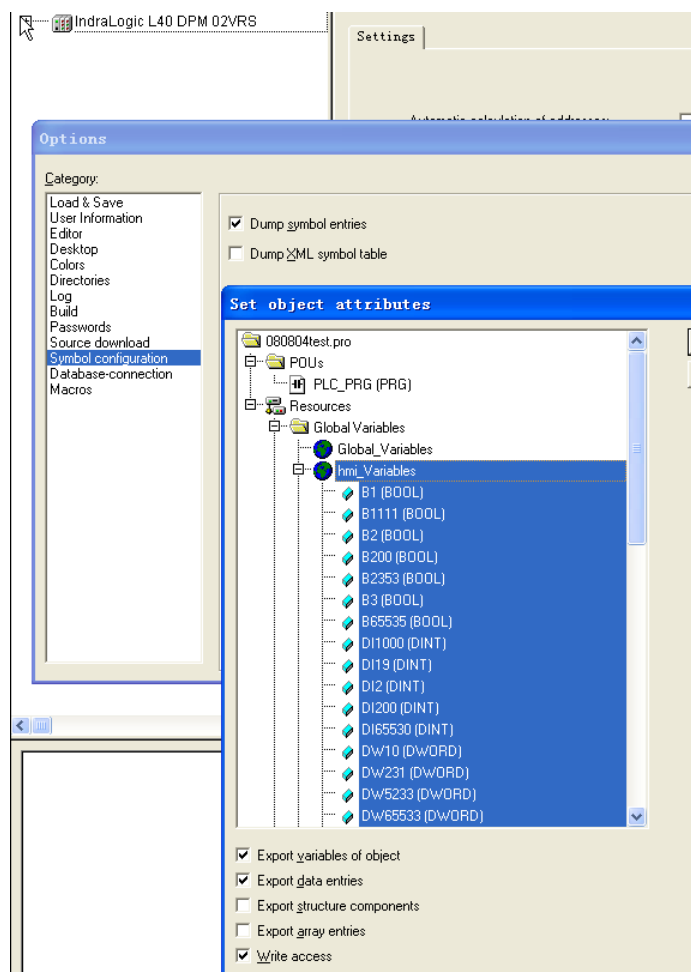
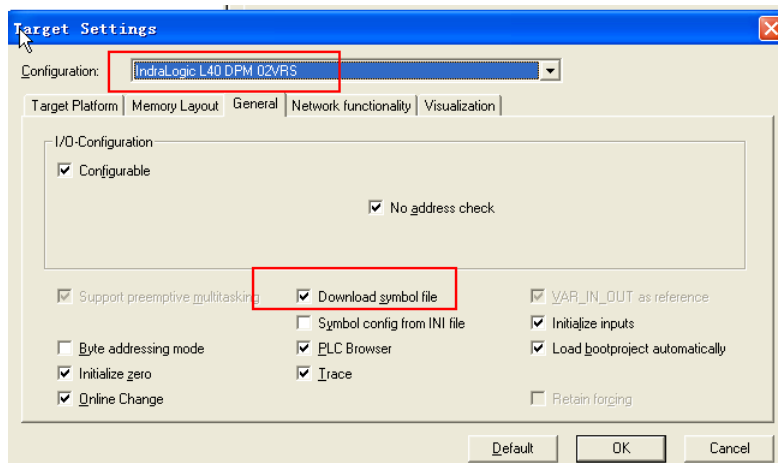

At this time open "indralogic" -->"online/communication parameter" -->"new" and select "TCP/IP" to modify "value", set IP address the same as controller: 192.168.100.103

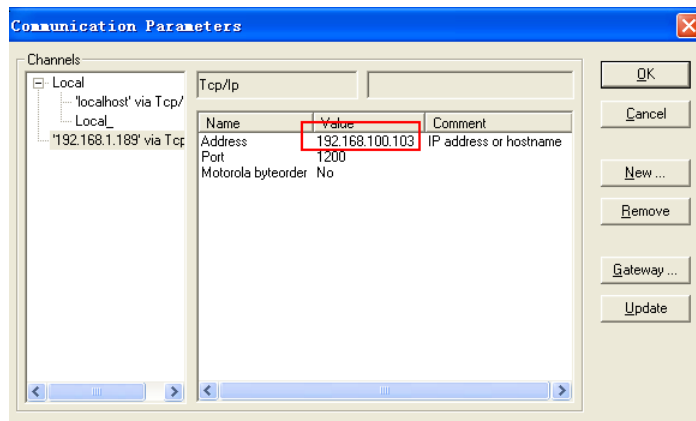

2. "resource"---->"Global variables"---->declare variable in "HMI"

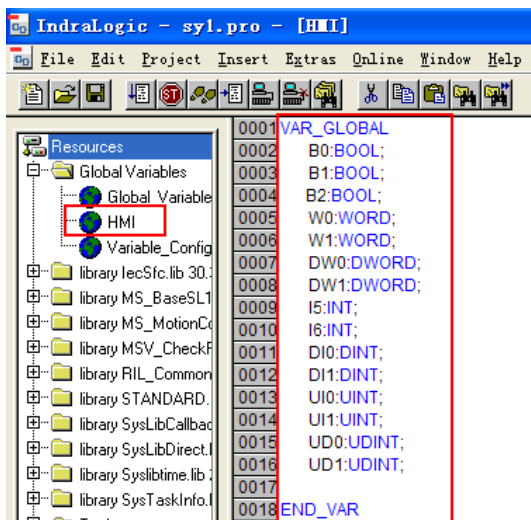

3. Click "online/login"

Supported Device

Device	Bit Address	Word Address	Format	Notes
BYTE	B0000-9999	-----	DDDD	
WORD	-----	W0-65535	DDDDD	
INT	-----	I0-65535	DDDDD	
UINT	-----	UI0-65535	DDDDD	
DWORD	-----	DW0-65535	DDDDD	
DINT	-----	DI0-65535	DDDDD	
UDINT	-----	UD0-65535	DDDDD	

Cable Diagram

Cross-connection or crossover network cable can be used as communication cable via the hub

a. Cross-connection cable diagram:

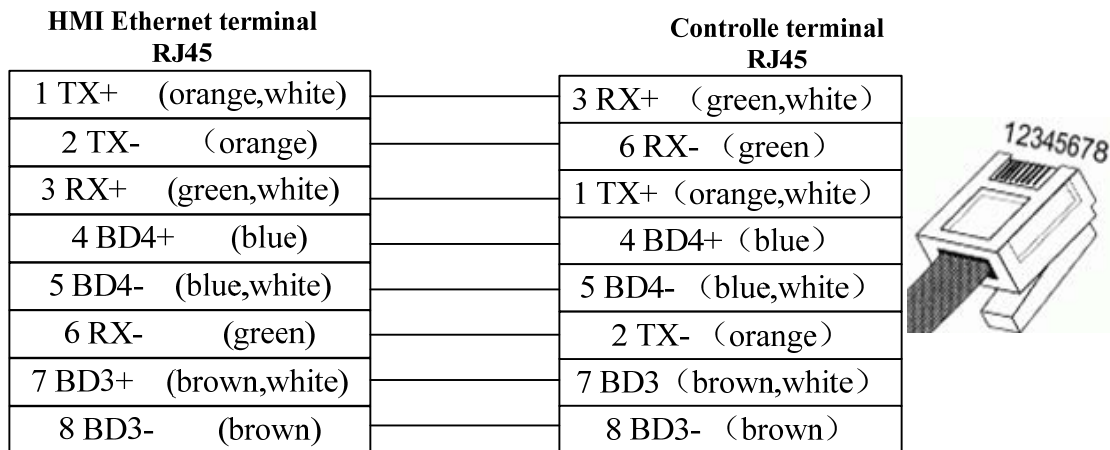

b. crossover network cable diagram:

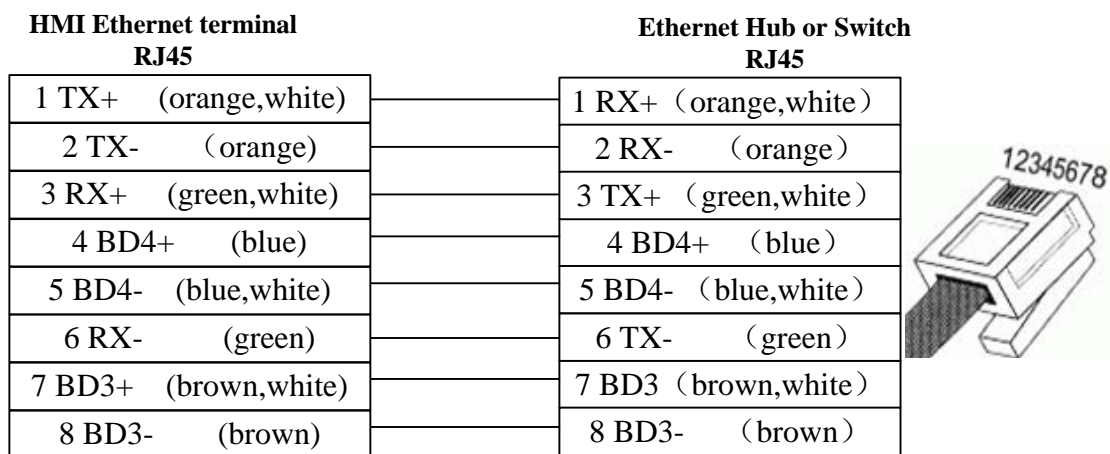

CANOpen Node Slave

Serial Communication

Series	CPU	Link Module	Driver
KINCO	K4	CAN port on the External Device	CANOpen Node Slave
Other company devices which support CANOpen		CANOpen port	

System configuration

Series	CPU	Link Module	Parameter	Cable
KINCO	K4	CAN port on the External Device	Setting	Your owner cable
Other company devices which support CANOpen		CAN port	Setting	

Communication Setting

HMI

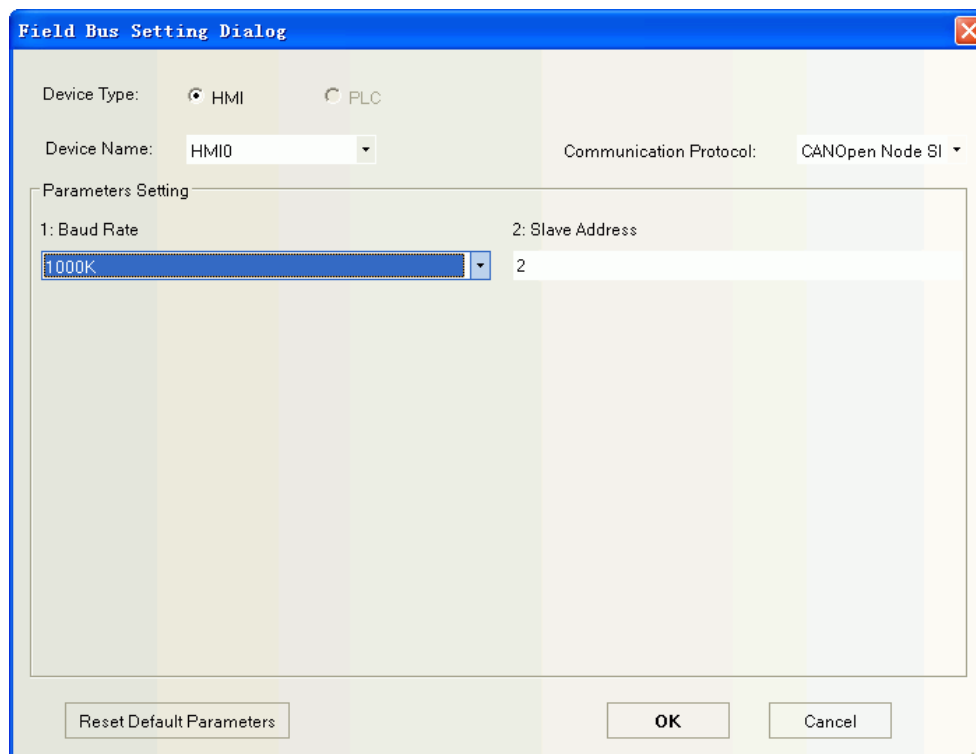

Note: Baud Rate and Station No. must be the same as the setting in the controller.

PLC setting

Note: you can find MT5020.EDS in fieldbus file of EV5000 Installation Directory, or you can download from www.kinco.cn.

Take MT6000 for example (we use MT6000 HMI to test, and use 3S CODESYS software to download project)

1. Setup

- Start Menu “3s Software”->“Codesys v2.3”->“installtarget”

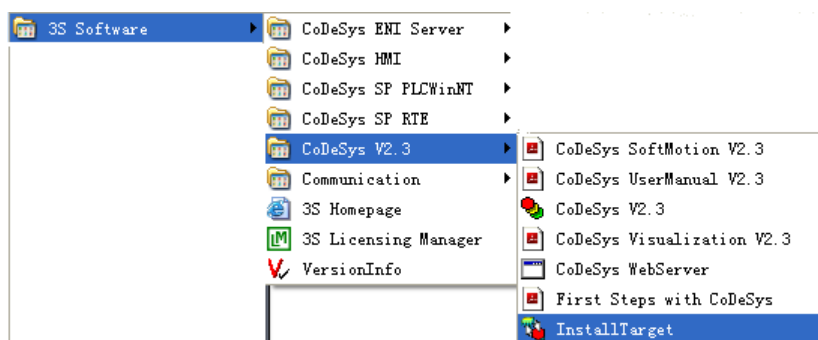

- Click “open” choose “StepServoARM.tnf”, and then click “install”.

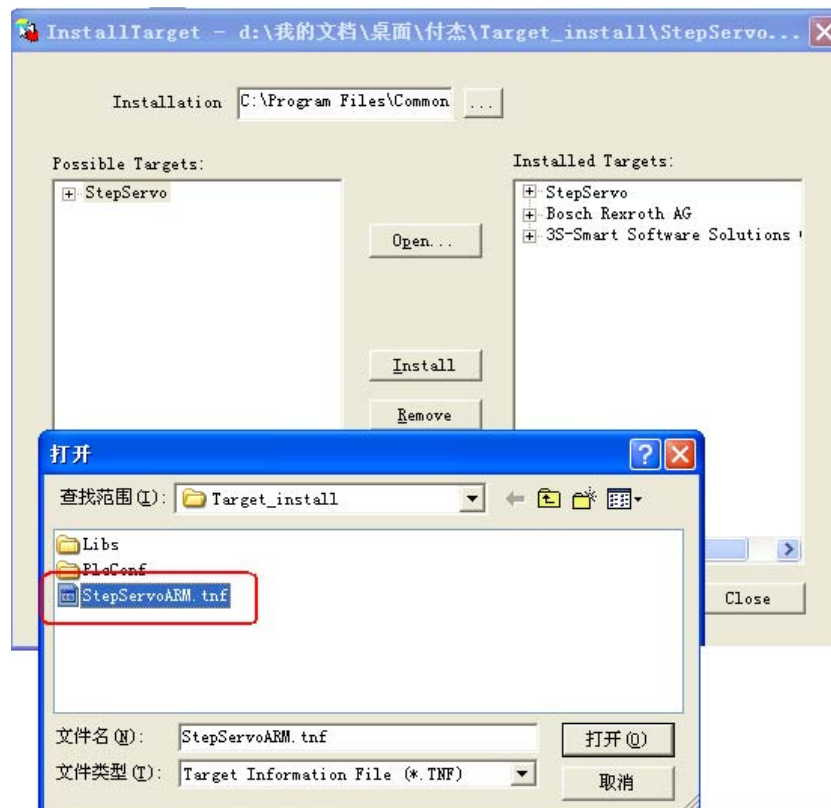

2. Copy "MT5020.EDS" to "C:\Program Files\Common Files\CAA -Targets\ StepServo\ PlcConf"

3. Configuration setting

a. run codesys software, make a new project

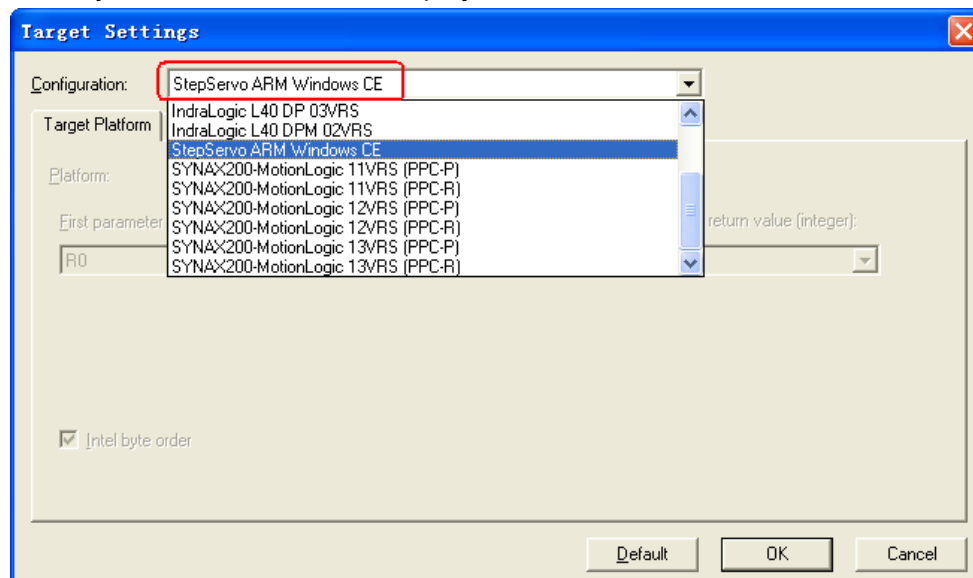

b. configuration setting, right click "PLC configuration" and choose "CanMaster"

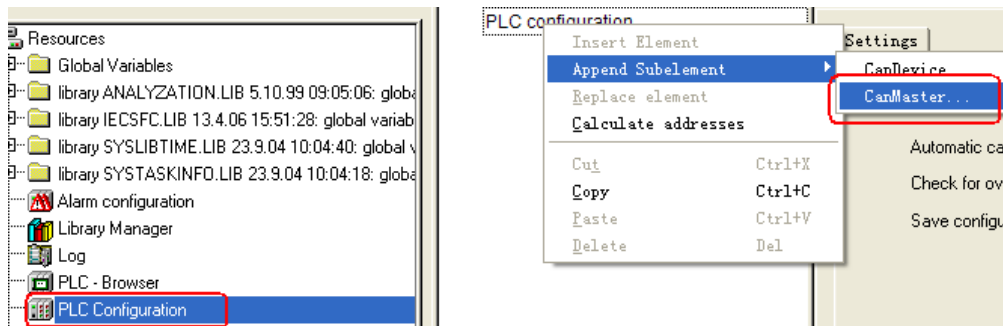

c. set Baud Rate

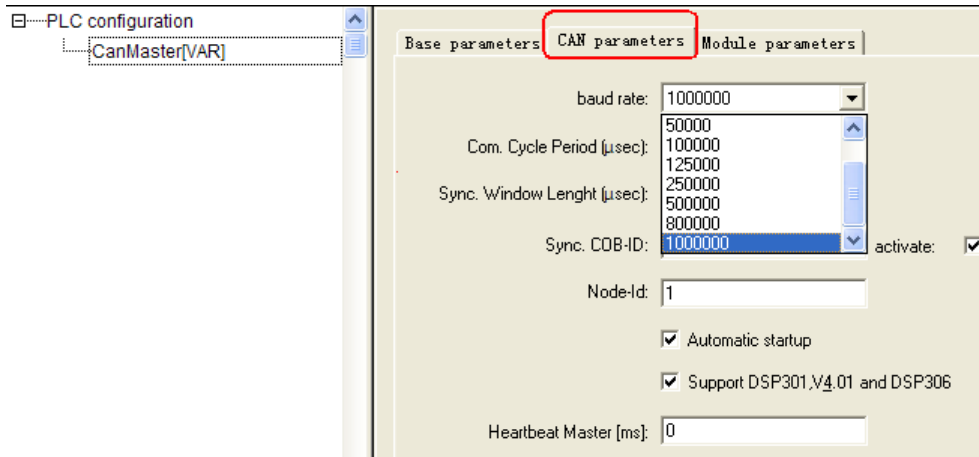

d. choose "CanMaster" right click "Append HMI-MT5020"

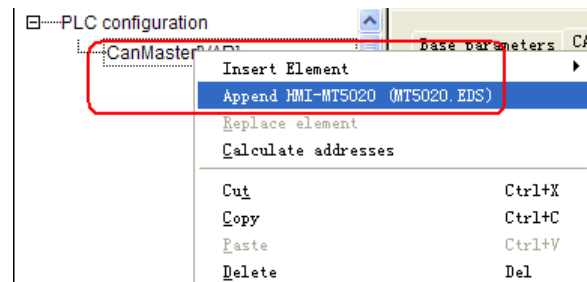

e. Node ID: set slave station No.

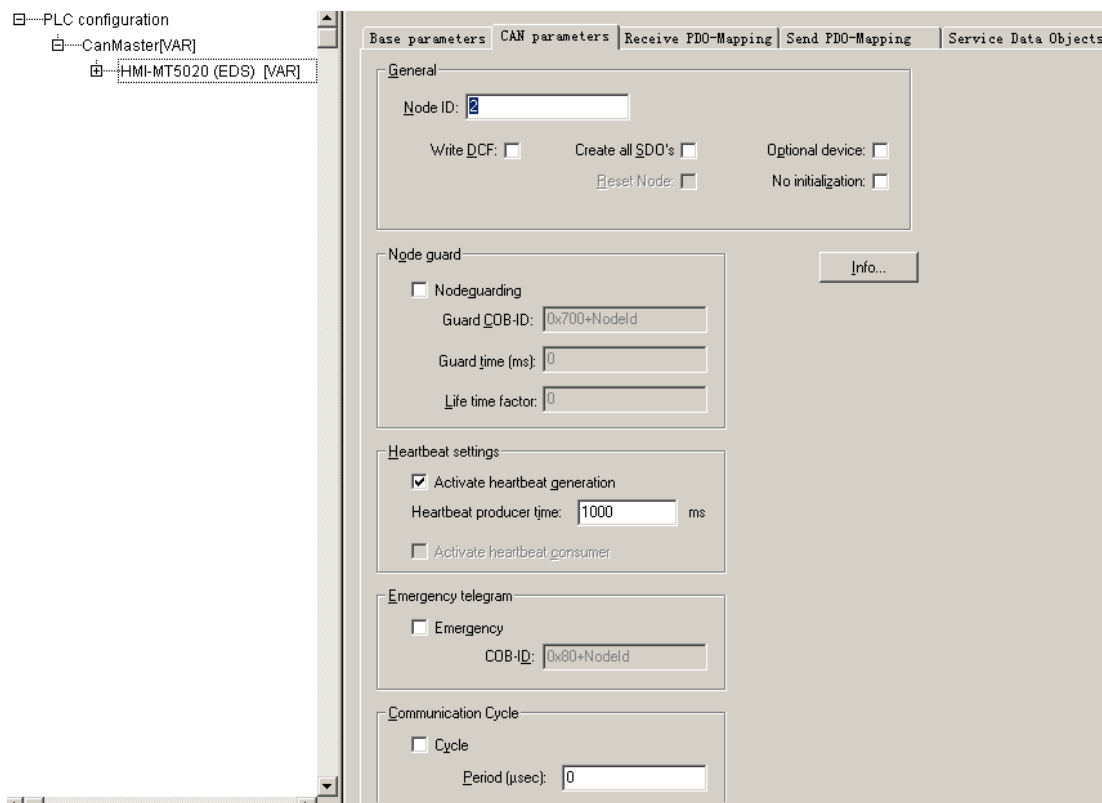

f. in the “Library Manager” we import “3S_CANOpenMaster.lib”

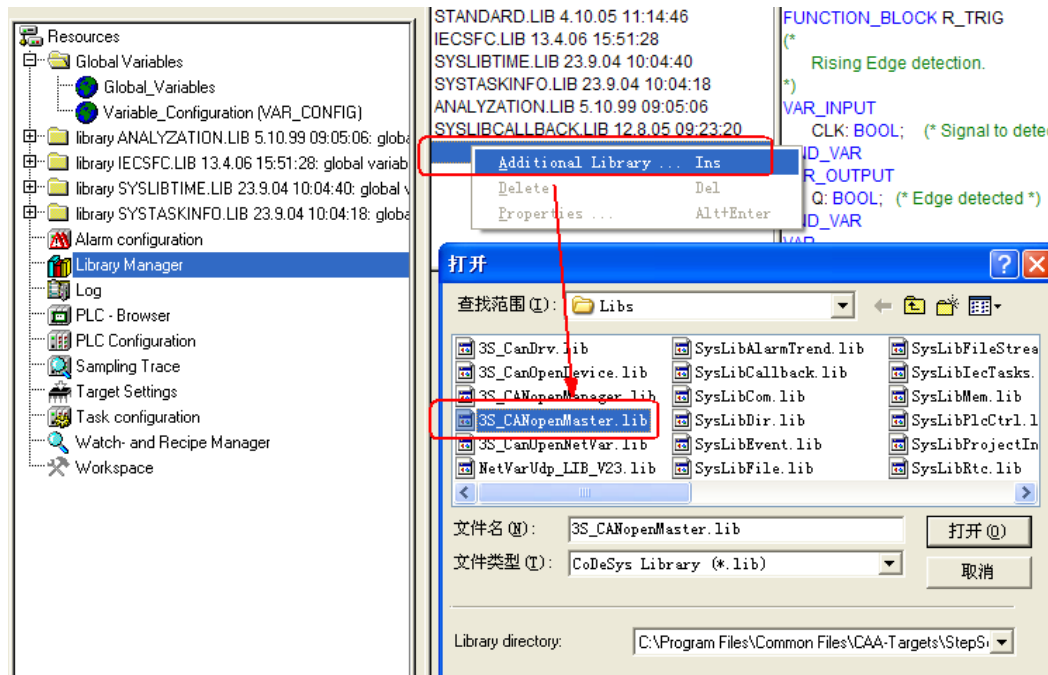

g. PDO read and write setting

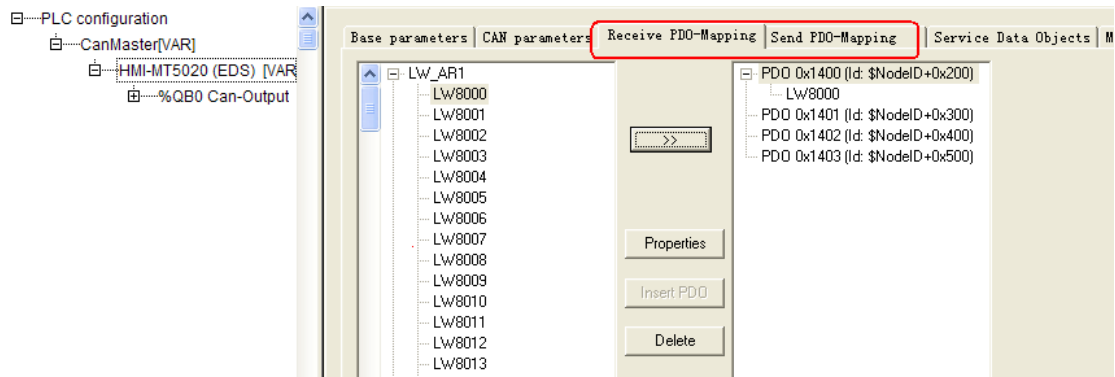

h. define Global Variable

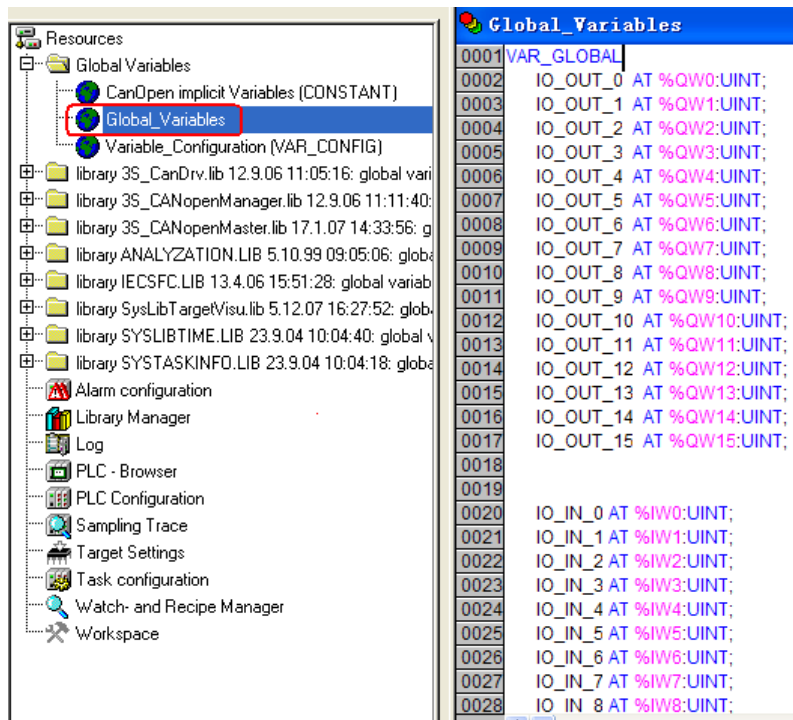

i. SDO setting, this step need program

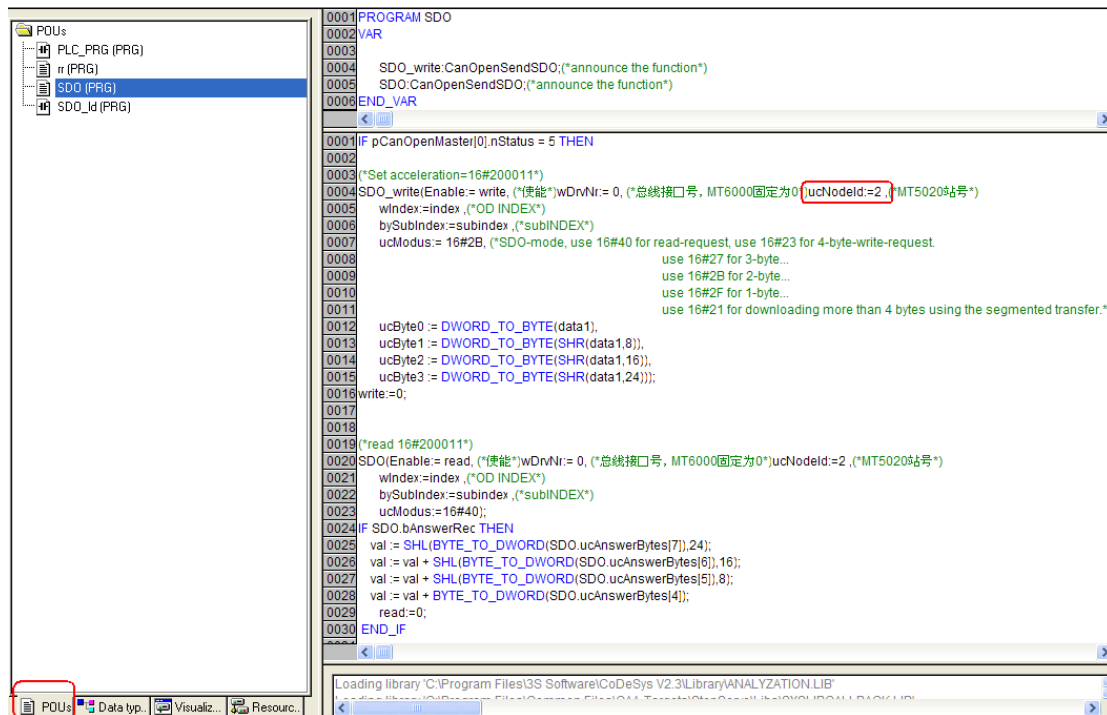

j. load the configuration into the PLC



Supported Device

Device	Bit Address	Word Address	Format	Notes
	—————	LW8000~LW8999	DDDD	

Note: we must make the setting of PD0, SD0 and LW the same as codesys

Cable Diagram

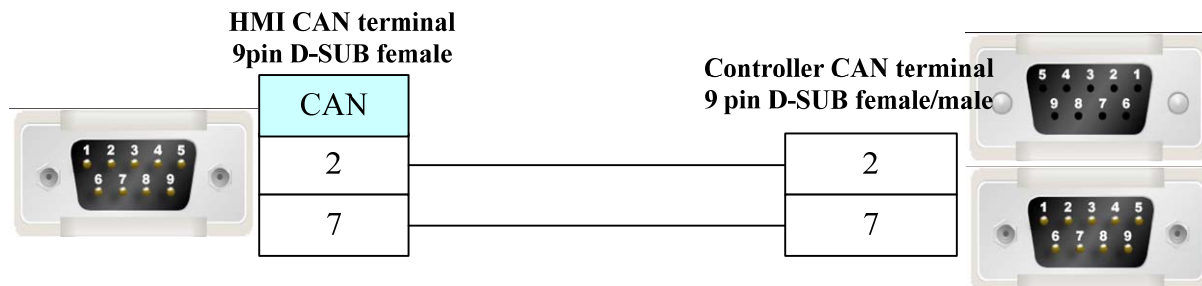

Danfoss Inverter

Serial Communication

Series	CPU	Link Module	Driver
Danfoss	FC-300	RS485 on the CPU unit	Danfoss Modbus RTU

System configuration

Series	CPU	Link Module	COMM Type	Parameter	Cable
Danfoss	FC-300	RS485 on the CPU unit	RS485-2	Setting	Your owner cable
Modbus RTU	FC-300	RS485 on the CPU unit	RS485-2	Setting	Your owner cable

Communication Setting

Danfoss Protocol:

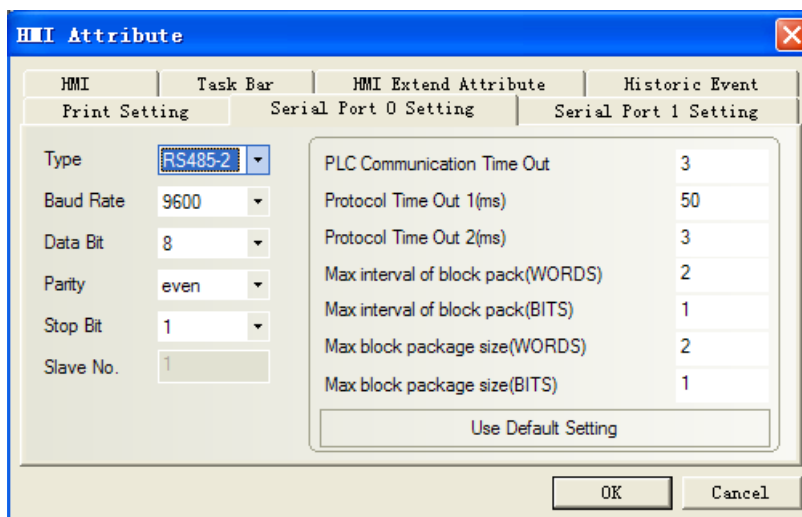

Modbus RTU Protocol:

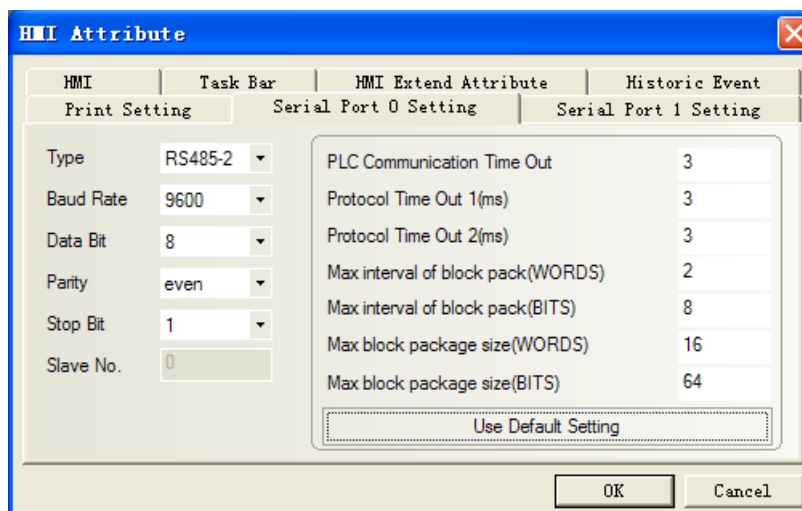

Note: Change the value of 8-30 to 2 on the Danfoss Frequency Converter for modbus protocol
(Change the value of 8-30 to 0 for the Danfoss Protocol)

Frequency Converter

8-3* FC Port Setting

8-30 protocol

- *[0] FC (danfoss protocol)
- [2] Modbus (modbus protocol)

8-31 address

- 1 – 247 * 1 (HMI station No.)

8-32 FC Port Baud Rate

- [0] 2400 Baud
- [1] 4800 Baud
- *[2] 9600 Baud

8-33 FC Port Parity

- *[0] even, 1 stop bit
- [1] Odd, 1 stop bit
- [2] None, 1 stop bit
- [3] None, 2 stop bit

Frequency Converter setting

Please refer to the manual of Danfoss Frequency Converter for details

Supported Device

Danfoss Protocol:

Device	Bit Address	Word Address	Format
EEPROM Register(Double Word)	————	EPD0-7998.99999	DDDD.DDDDD
EEPROM Register	————	EPW0-7998.99999	DDDD.DDDDD

RAM Register(Double Word)	_____	RMD0-7998.99999	DDDD.DDDDD
RAM Register	_____	RMW0-7998.99999	DDDD.DDDDD

Note:

1. D indicates decimal; the prefix of RMD\RMW\EPD\EPW is address parameter, the suffix is index number.

2. Mapping of index address (adding radix point if having index address, index value follow radix point. Otherwise there's no radix point):

RMW310.1 is to 3-10, please clicking Menu, to find 3-10 to check.

3. If no index, radix point followed by default zero. As follows RMW122 to 1-22:

4. R/W of process word:

- 1) Address of EPD register is 8000, is for saving input command value of process word;
- 2) Address of EPD register is 8100, is for saving return value of process word;
- 3) Input command value and return value can be showed by RW register.
- 4) Start\Stop, Mapping of reference value to frequency:

Reason: RWD8000 is for inputting control word, it's not able to input control word by itself, but via sending RW1, RW0 to RWD8000 by timer.

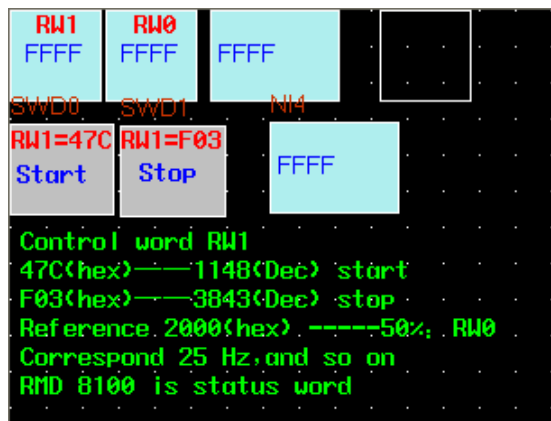

◆ Control word RW1: While RW1=0x47C or 1148, it means start. While RW=0x0F03 or 3843, it means stop.

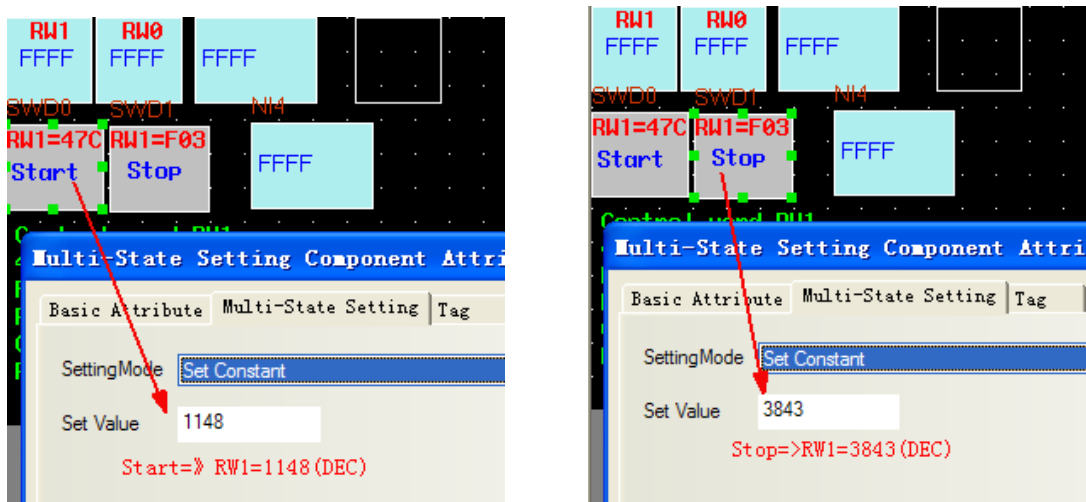

◆ Frequency of RW0 mapping : If input 2000 to RW0, frequency is 25HZ, and input 4000, frequency is 50HZ, and so on.

◆ Timer, send value of RW1 and RW0 to RWD8000.

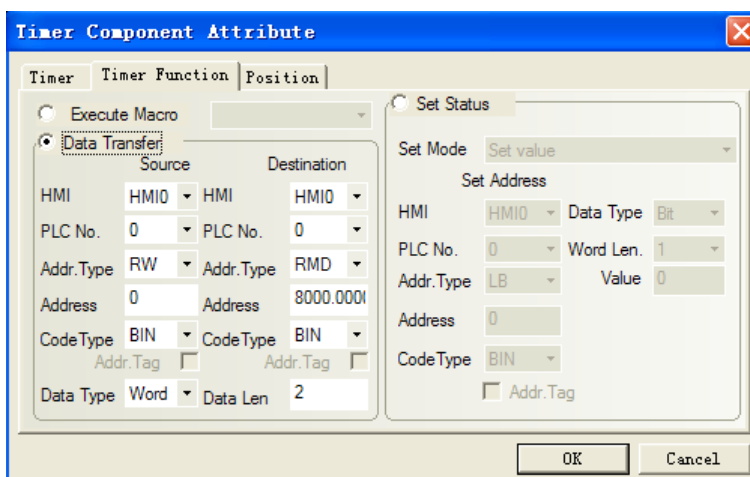

Modbus RTU Protocol:

Device	Bit Address	Word Address	Format	Notes
Output bit	0X1-65535	-----	DDDDD	

Input bit (read only)	1X1-65535	-----	DDDDD	
Input Register (read only)	-----	3X1-65535	DDDDD	
Output Register	-----	4X1-65535	DDDDD	

Note:

Mapping of address (same as *10 relationships):

2-01 is to 4X2010

3-02 is to 4X3020

So address 4X1300 is to 1-30 as following picture, here is double word address. To get more information, please refer to danfoss manual.

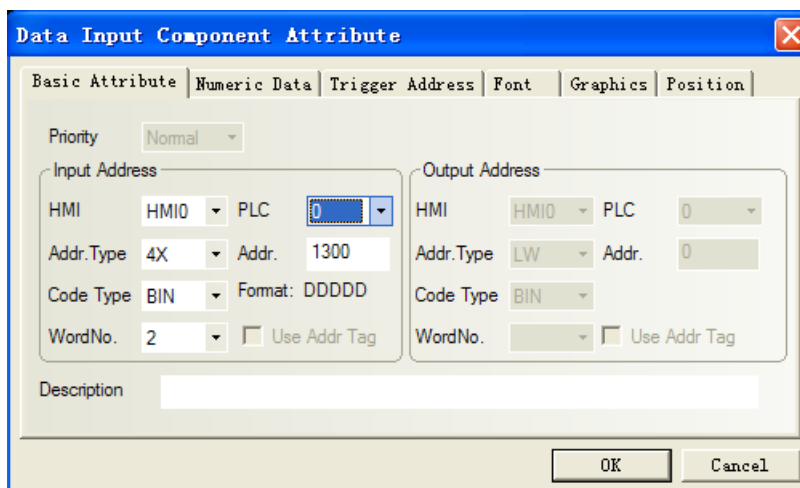

In addition, to get mapping address of startup, you should set bit of 3, 4, 5, 6,7,11 coil on:
0x047C=0000 0100 0111 1100

Set 0X 3, 0X 4, 0X 5, 0X 6, 0X 7, 0X 11 all to "1" (if random one of these registers is "0",
Frequency Converter will stop.

loop	0	1
01	Preset reference value LSB	
02	Preset reference value MSB	
03	DC brake	Do not DC brake
04	Inertial stop	Do not Inertial stop
05	Quickly stop	Do not Quickly stop
06	locking frequency	Do not locking frequency
07	Acc/Dec stop	start
08	Do not reset	reset
09	Do not inching	inching
10	Acc/Dec 1	Acc/Dec 2
11	valid data	invalid data
12	Relay 1 close	Relay 1 open
13	Relay 2 close	Relay 2 open
14	Set LSB	
15	Set MSB	
16	Do not reverse	reverse
Transducer controller word (FC structure)		

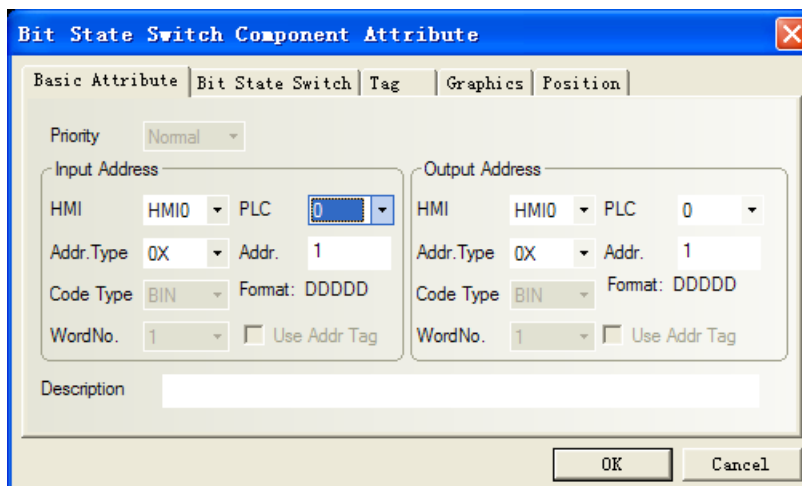

Set 0X 3, 0X 4, 0X 5, 0X 6, 0X 7 all to “1” via the method of setting on when window open; Change the frequency inverter status (start or stop) by control the status of 0X11.

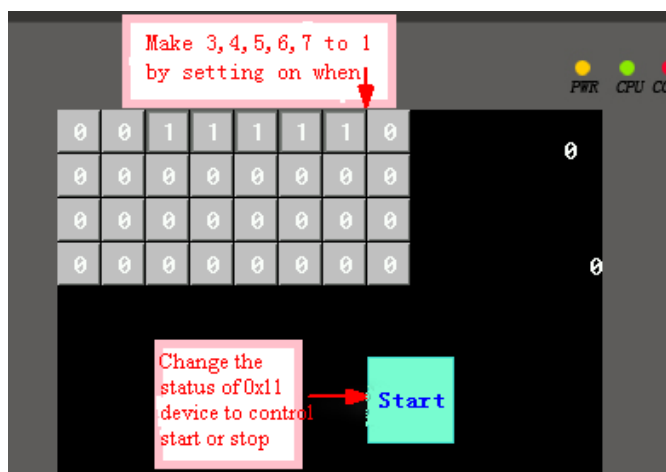

0x2000=0010 0000 0000 0000(binary bit from the 17th to the 32nd), setting the 30th bit to “1” means frequency is 25Hz, and “1” in the 29th bit means 12.5Hz, and so on. In short, the 0X17~0X32 is to control frequency. The Frequency Converter will show the value after starting.

0X17~0X32 for controlling frequency, mapping as follows:

- 0x4000 ——50Hz
- 0x2000 ——25Hz
- 0x1000 ——12.5Hz (approximate)
- 0x800 ——6Hz

And so on, about 80 times

Cable Diagram

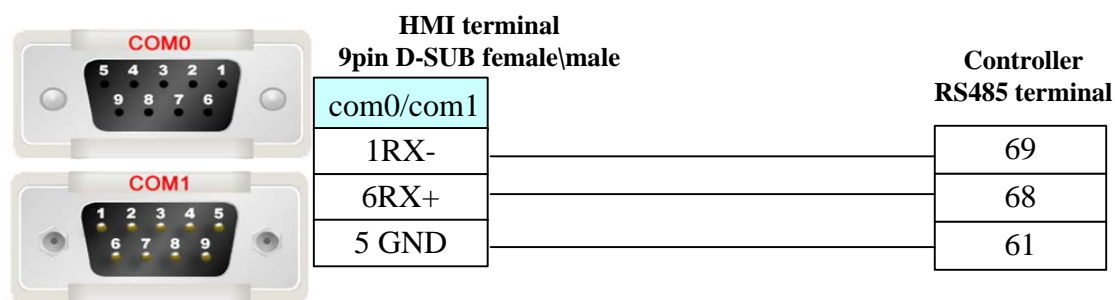

Delta Corporation

Serial Communication

Series	CPU	Link Module	Driver
DVP	DVP14SS11R2 DVP 24 DVP 32 DVP 60ES00 DVP-XXES01	RS232 on the CPU unit	Delta DVP
		RS485 on port	

System configuration

Series	CPU	Link Module	COMM Type	Parameter	Cable
DVP	DVP14SS11R2 DVP 24 DVP 32 DVP 60ES00 DVP-XXES01	RS232 on the CPU unit	RS232	Setting	Your owner cable
		RS485 on port	RS485-2	Setting	Your owner cable

Communication Setting

DVP RS232 communication

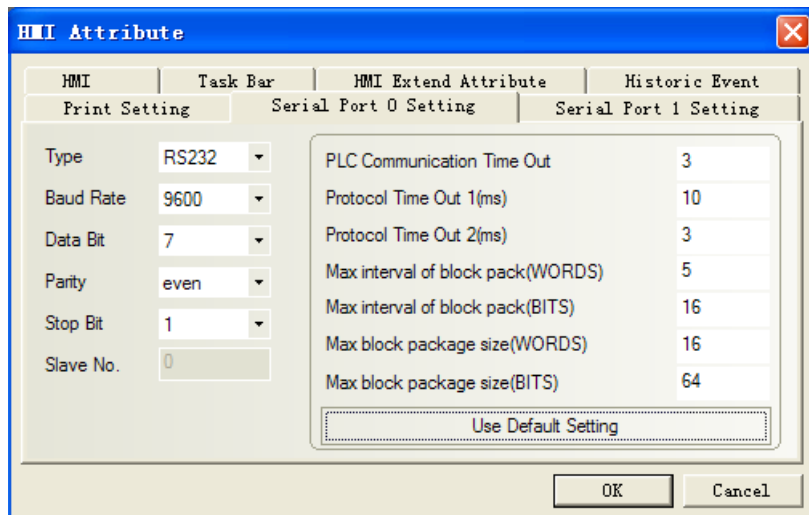

DVP RS485-2 communication

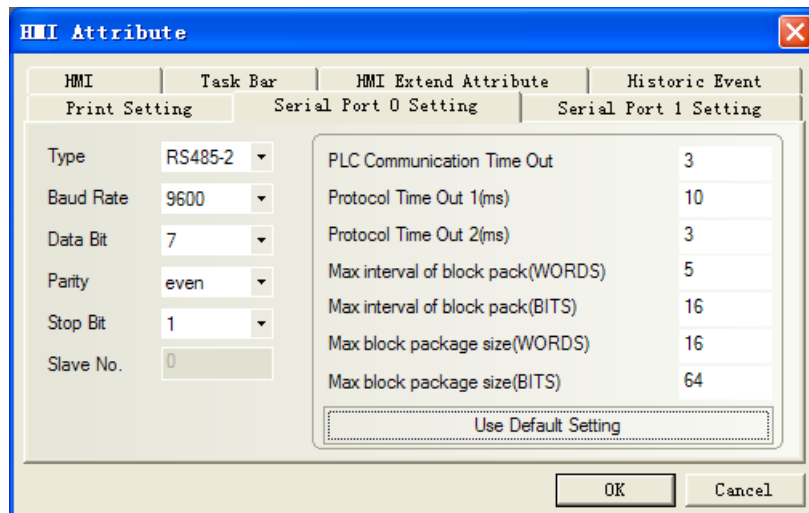

Note: if we use RS485 communication, we should change the value of D1120 in the PLC Software.

PLC setting

1. Wpl207->Auxiliary Editing->RS-485 Protocol Setting (D1120), you can set the value of D1120.

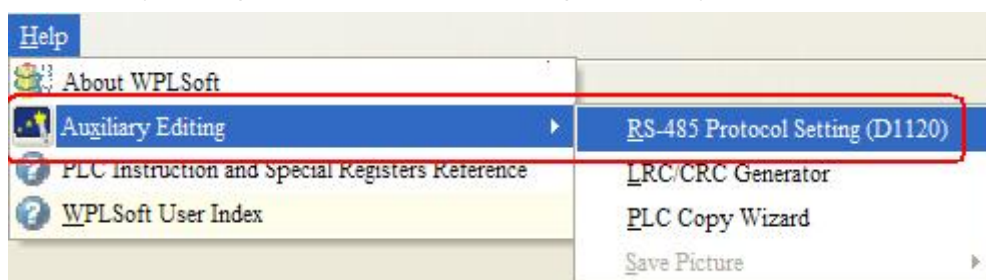

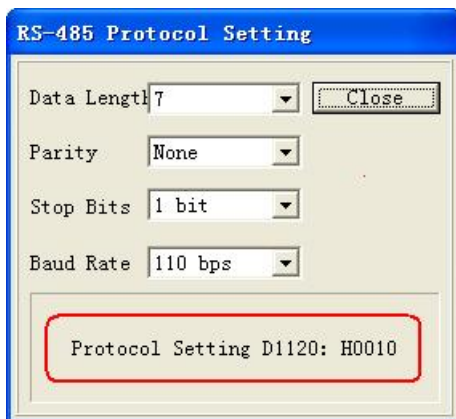

2. when PLC and Wpl207 are connective, change D1120. for example, 9600, 7, even, 1.and then D1120=86 (HEX)

Supported Device

Device	Bit Address	Word Address	Format	Notes
Input	X0-9999	-----	OOOO	
Output	Y0-9999	-----	OOOO	
Auxiliary Relay	M0-9999	-----	DDDD	
Step Relay	S0-9999	-----	DDDD	
Timer Relay	T0-9999	-----	DDDD	
Counter Relay	C0-9999	-----	DDDD	
Timer	-----	TV0-9999	DDDD	
Counter	-----	CV0-127	DDD	
Double word counter	-----	CV2 232-255	DDD	
Data Register	-----	D0-9999	DDDD	

Cable Diagram

DVP RS232 communication cable

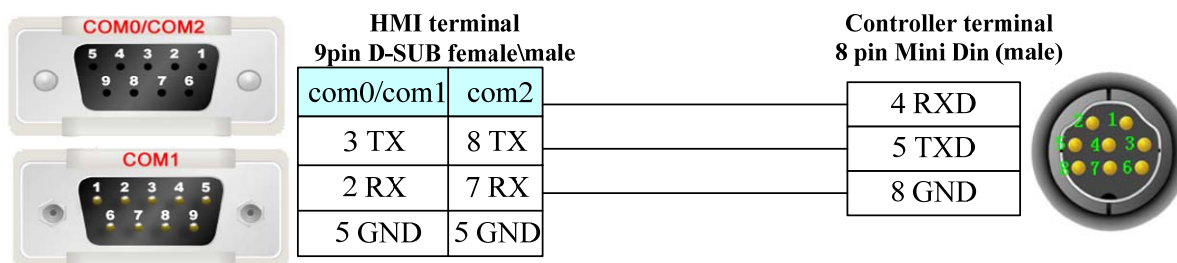

DVP RS485-2 communication cable

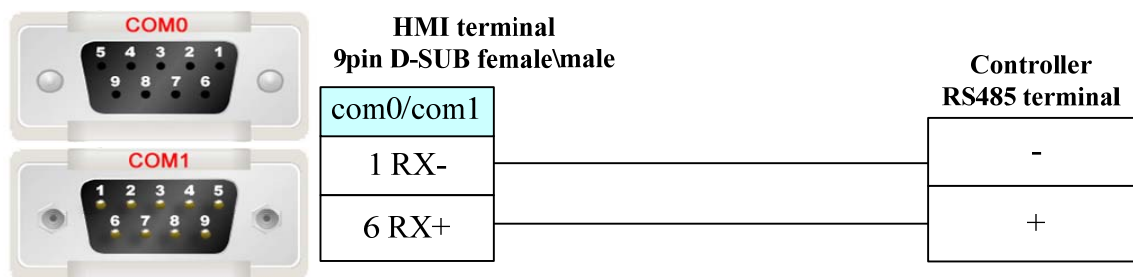

Delta (Temperature Controller)

Serial Communication

Series	CPU	Link Module	Driver
DVP	DTA4848	RS485 on the CPU unit	Delta DTA_DTB
	DTB9696VR	RS485 on the CPU unit	

System configuration

Series	CPU	Link Module	COMM Type	Parameter	Cable
DVP	DTA4848	RS485 on port	RS485-2	Setting	Your owner cable
	DTB9696VR	RS485 on port	RS485-2	Setting	Your owner cable

Communication Setting

RS485-2 communication

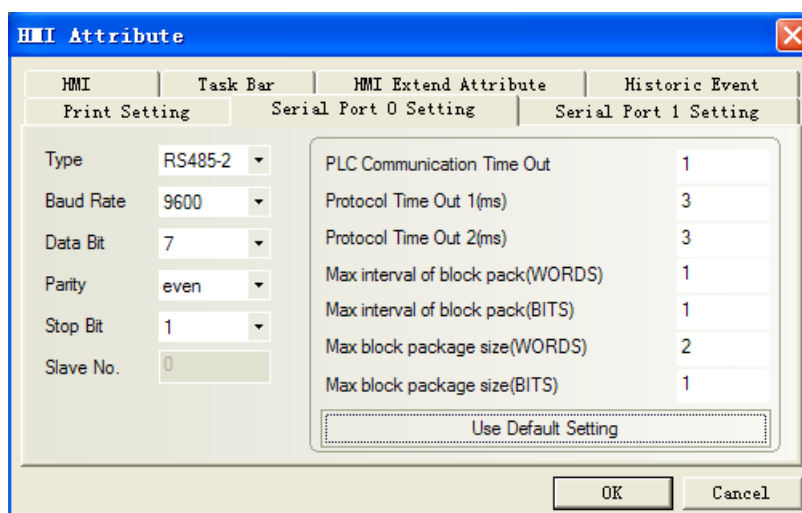

Note: Only use 4X, not 3X in the ev5000 project.





Supported Device

Device	Bit Address	Word Address	Format	Notes
Output bit	0X1-65535	-----	DDDDD	
Input bit (read only)	1X1-65535	-----	DDDDD	
Input Register (read only)	-----	3X1-65535	DDDDD	
Output Register	-----	4X1-65535	DDDDD	

Controller Setting

1. Set the communication parameter

Setting communication parameter in “setting mode”

- (1)  (Station number) matching the station No. of the Ev5000
- (2)  (Baudrate)
- (3)  (Data bit)
- (4)  (Parity)
- (5)  (Stop bit)





Non-supported formats: 7, N, 1 or 8, O, 2 or 8, E, 2(Databit、Parity、Stopbit).

(6) Setting the parameter of CoSH

The data must be ON when executing write operation in touch-screen.

2. Communication parameters and notes

DTA4848: Address and Content of Word Register (corresponds to 4X in the HMI)

Address	Content	Explanations
4700H	Process value (PV)	
4701H	Set point (SV)	
4702H	Upper-limit alarm 1	In the running mode  , when ALA1 is 1 and Upper-limit alarm is valid.
4703H	Lower-limit alarm 1	In the running mode  , when ALA1 is 1 and Lower-limit alarm is valid.
4704H	Upper-limit alarm 2	In the running mode  , when ALA2 is 2 and Upper-limit alarm is valid.
4705H	Lower-limit alarm 2	In the running mode  , when ALA2 is 2 and Lower-limit alarm is valid.
4706H	Upper-limit of temperature range	The data content should not be higher than the temperature

		range. In the setting mode EP-H
4707H	Lower-limit of temperature range	The data content should not be lower than the temperature range. In the setting mode EP-L
4708H	PB Proportional band	1 to 9999, unit is 0.1. In the adjusting mode P
4709H	Ti Integral time	0~9999. In the adjusting mode I
470AH	Td Derivative time	0~9999. In the adjusting mode D
470BH	Heating/Cooling hysteresis	0~9999
4710H	Input temperature sensor type	In the setting mode CPt
4711H	Control method	0: PID (default), 1: ON/OFF, 2: manual tuning. In the setting mode Ctrl
4712H	Heating/Cooling control cycle	0 to 99 second, 0:0.5s, in the adjusting mode HEPd or CLPd , when it is under the control of PID
4713H	Proportional control offset error value	0%~100%
4714H	Temperature regulation value	-99.9~99.9. in the adjusting mode EPoF
4715H	Alarm 1 type	Please refer to the contents of the “Alarm Outputs” for detail. In the setting mode ALA1
4716H	Alarm 2 type	Please refer to the contents of the “Alarm Outputs” for detail. In the setting mode ALA2
4717H	Temperature unit display selection	°C : 1 (default), °F : 0. in the setting mode EPUn
4718H	Heating/Cooling control Selection	Heating: 0 (default), Cooling: 1. in the setting mode S-HC
4719H	Control Run/Stop setting	Run: 1 (default), Stop: 0. in the running mode r-S
471AH	Communication write-in selection	Communication write in disabled: 0 (default), Communication write in enabled: 1. In the setting mode CoSH
471BH	Software Version	V1.00 indicates 0 x 100

4729H	AT Setting	OFF: 0 (default), ON: 1. in the adjusting mode At
4733H	CT monitor value	Unit is 0.1A. in the running mode ct







DTB9696VR: Address and Content of Word Register (corresponds to 4X in the HMI)

Address	Content	Explanation
1000H	Process value (PV)	Measuring unit is 0.1, updated one time in 0.4 second
1001H	Set point (SV)	Unit is 0.1, °C or °F
1002H	Upper-limit of temperature range	The data content should not be higher than the temperature range. In the setting mode tp-H
1003H	Lower-limit of temperature range	The data content should not be lower than the temperature range. In the setting mode tp-L
1004H	Input temperature sensor type	Please refer to the contents of the “Temperature Sensor Type and Temperature Range” for detail. In the setting mode tpT
1005H	Control method	0: PID, 1: ON/OFF, 2: manual tuning, 3: PID program control. In the setting mode ctrl
1006H	Heating/Cooling control selection	0: Heating, 1: Cooling, 2: Heating/Cooling, 3: Cooling/Heating. In the setting mode S-HC
1007H	1st group of Heating/Cooling control cycle	0 ~ 99, 0:0.5 sec. in the adjusting mode HtPd or clPd
1008H	2nd group of Heating/Cooling control cycle	0 ~ 99, 0:0.5 sec. in the adjusting mode HCPd
1009H	PB Proportional band	0.1 ~ 999.9. in the adjusting mode P0
100AH	Ti Integral time	0~9999. in the adjusting mode i0
100BH	Td Derivative time	0~9999. in the adjusting mode d0
100CH	Integration default	0 ~ 100%, unit is 0.1%. in the adjusting mode ioF0
100DH	Proportional control offset error value, when Ti = 0	0 ~ 100%, unit is 0.1%. in the adjusting mode PdoF
100EH	The setting of COEF when Dual Loop output control are used	0.01 ~ 99.99, unit is 0.01 (setting when it is under the control of PID) in the adjusting mode CoEF

100FH	The setting of Dead band when Dual Loop output control are used	-999 ~ 9,999. in the adjusting mode DEAD
1010H	Hysteresis setting value of the 1st output group	0~9999. in the adjusting mode HtS or ctS
1011H	Hysteresis setting value of the 1st output group	0~9999. (setting when Dual Loop output control are used) in the adjusting mode HtS or ctS
1012H	Hysteresis setting value of the 1st output group	Unit is 0.1%; write operation is valid under manual tuning mode only. In the running mode out1
1013H	Hysteresis setting value of the 2nd output group	Unit is 0.1%; write operation is valid under manual tuning mode only. In the running mode out2
1014H	Upper-limit regulation of analog linear output	1 Unit = 2.8uA (Current Output) = 1.3mV (Linear Voltage Output) in the adjusting mode CrHc
1015H	Lower-limit regulation of analog linear output	1 Unit = 2.8uA (Current Output) = 1.3mV (Linear Voltage Output) in the adjusting mode CrLo
1016H	Temperature regulation value	-99.9 ~ +99.9, unit: 0.1. in the adjusting mode tPoF
1017H	Analog decimal setting	0~3. in the running mode SP
1018H	Time for valve from full open to full close	0.1~999.9. in the adjusting mode uAtr
1019H	Dead Band setting of valve	0 ~ 100%; unit: 0.1%. in the adjusting mode u-dE
101AH	Upper-limit of feedback signal set by valve	0~1024. in the adjusting mode u-Hc
101BH	Lower-limit of feedback signal set by valve	0~1024. in the adjusting mode u-Lo
101CH	PID parameter selection	0~4. in the adjusting mode PcOn
101DH	SV value corresponded to PID value	Only valid within available range, unit: 0.1 scale. in the adjusting mode Su0
1020H	Alarm 1 type	In the setting mode ALA1
1021H	Alarm 2 type	In the setting mode ALA2
1022H	Alarm 3 type	In the setting mode ALA3
1023H	System alarm setting	0: None (default), 1~3: Set Alarm 1 to Alarm 3.

		In the setting mode SALA
1024H	Upper-limit alarm 1	In the setting mode AL1H unit: 0.1
1025H	Lower-limit alarm 1	In the setting mode AL1L
1026H	Upper-limit alarm 2	In the setting mode AL2H
1027H	Lower-limit alarm 2	In the setting mode AL2L
1028H	Upper-limit alarm 3	In the setting mode AL3H
1029H	Lower-limit alarm 3	In the setting mode AL3L
102AH	Read LED status	b0 : Alm3, b1: Alm2, b2: F, b3: °C, b4: Alm1, b5: OUT2, b6: OUT1, b7: AT
102BH	Read pushbutton status	b0: Set, b1: Select, b2: Up, b3: Down. 0 is to push
102CH	Setting lock status	0: Normal, 1: All setting lock, 11: Lock others than SV value. In the running mode LoC
102DH	CT read value	Unit: 0.1A. In the running mode ct
102FH	software version	V1.00 indicates 0x100.
1030H	Start pattern number	0 ~ 7. In the running mode Ptern (setting when it is under the control of PID and the mode of PSTEP)
1040H~ 1047H	Actual step number setting inside the correspond pattern	0 ~ 7 = N, indicate that this pattern is executed from step 0 to step N. in the setting mode PSy0
1050H~ 1057H	Cycle number for repeating the execution of the correspond pattern	0 ~ 99 indicate that this pattern has been executed for 1 ~ 100 times. In the setting mode CYCO
1060H~ 1067H	Link pattern number setting of the correspond pattern	0 ~ 8, 8 indicates the program end. 0~7 indicates the next execution pattern number after executing the current pattern. In the setting mode LNn0
2000H~ 203FH	Pattern 0~7 temperature set point setting(Pattern 0 temperature is set to2000H ~ 2007H)	-999 ~ 9,999. in the setting mode SP00 ~ SP07
2080H~ 20BFH	Pattern 0~7 execution time setting(Pattern 0 time is set to 2080H~2087H)	Time 0 ~ 900 (1 minute per scale). in the setting mode t200 ~ t207

DTB9696VR: Address and Content of Bit Register (corresponds to 1X in the HMI)

0810H	Communication write-in selection	Communication write in disabled: 0 (default), Communication write in enabled: 1. In the setting mode 
0811H	Temperature unit display selection	°C/linear input (default): 1, °F : 0. in the setting mode 
0812H	Decimal point position selection	Except for the thermocouple B, S, R type, all the other thermocouple type are valid. (0 or 1). In the running mode 
0813H	AT setting	OFF: 0 (default), ON : 1. In the adjusting mode 
0814H	Control RUN/STOP setting	0: STOP, 1: RUN (default). In the running mode 
0815H	STOP setting for PID program control	0: RUN (default), 1: STOP. In the running mode 
0816H	Temporarily STOP for PID program control	0: RUN (default), 1: Temporarily STOP. In the running mode 
0817H	Valve feedback setting status	0: w/o feedback (default), 1: feedback function.
0818H	Auto-tuning valve feedback status	0: Stop AT (default), 1: Start AT

3. Communication Parameters List

- Communication protocol: Modbus (ASCII); Available communication address: 1 to 255, 0 is broadcast address
- Function code: 03H: read the contents of register (Max. 3 words).
06H: write 1 (one) word into register.

Cable Diagram

DVP RS485-2 communication cable

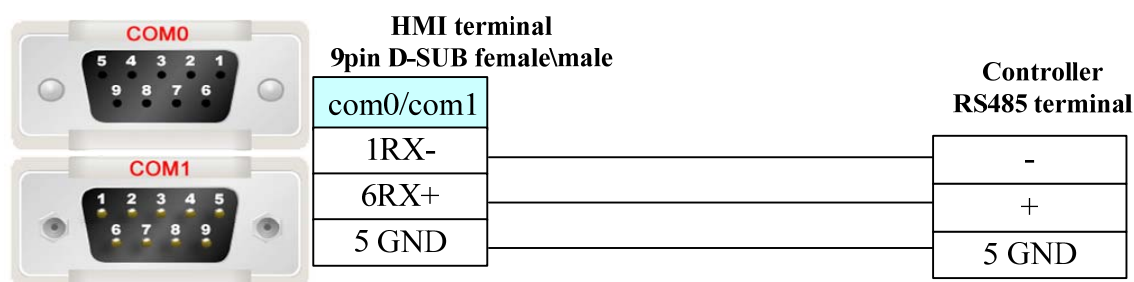

D3Cell™

Serial Communication

Series	CPU	Link Module	Driver
D3Cell™	D3Cell™	RS422 on the CPU unit	DLoadCell

System configuration

Series	CPU	Link Module	COMM Type	Parameter	Cable
D3Cell™	D3Cell™	RS485 on the CPU unit	RS422	Setting	Your owner cable

Supported Device

For detailed device, please refer to the PLC manual.

Communication Setting

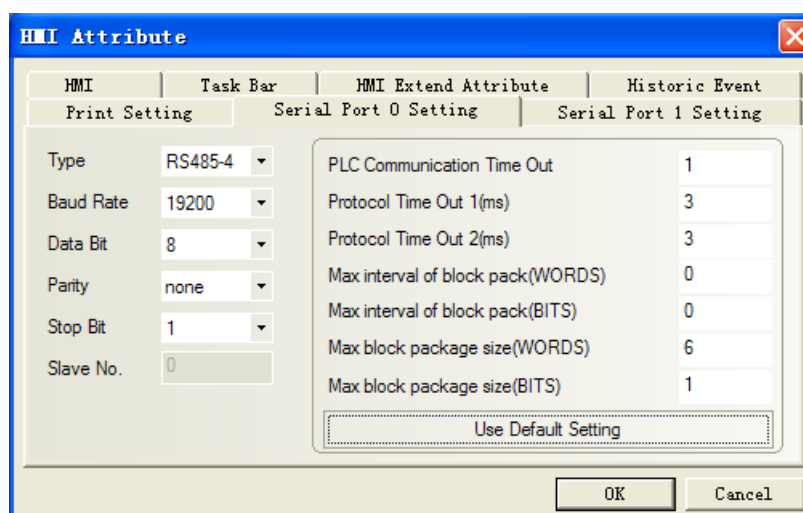

Cable Diagram

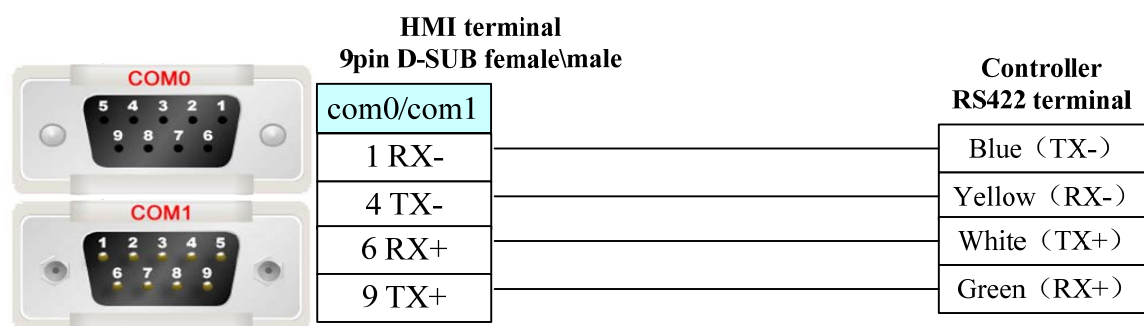

EB-MOD2P-01(Bus Bridge)

Serial Communication

Series	CPU	Link Module	Driver
FieldBus Bridge	EB-MOD2P-01	RS232 on the CPU unit	EB-MOD2P-01
		RS485 on the CPU unit	
		RS422 on the CPU unit	

System configuration

Series	CPU	Link Module	COMM Type	Parameter	Cable
FieldBus Bridge	EB-MOD2P-01	RS232 on the CPU unit	RS232	Setting	Your owner cable
		RS422 on the CPU unit	RS422	Setting	Your owner cable
		RS485 on the CPU unit	RS485	Setting	Your owner cable

Communication Setting

EB-MOD2P-01 RS232 communication

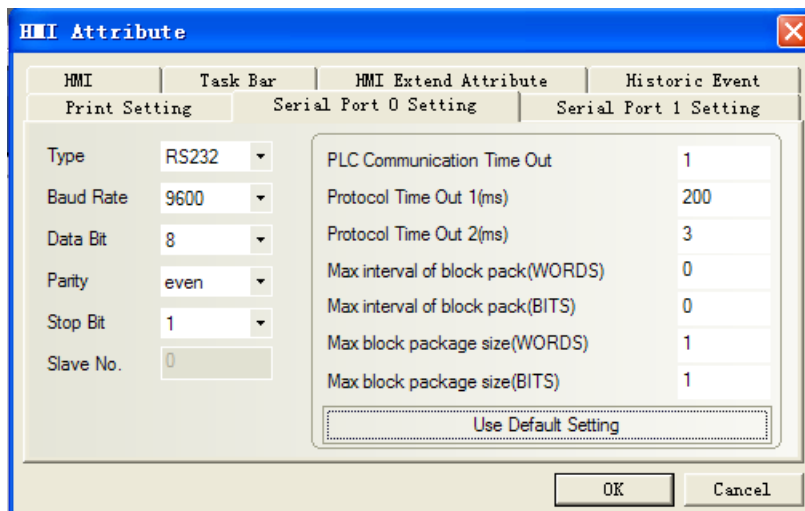

Note: Communication parameter must be the same as the controller panel.

EB-MOD2P-01 RS485-4 communication

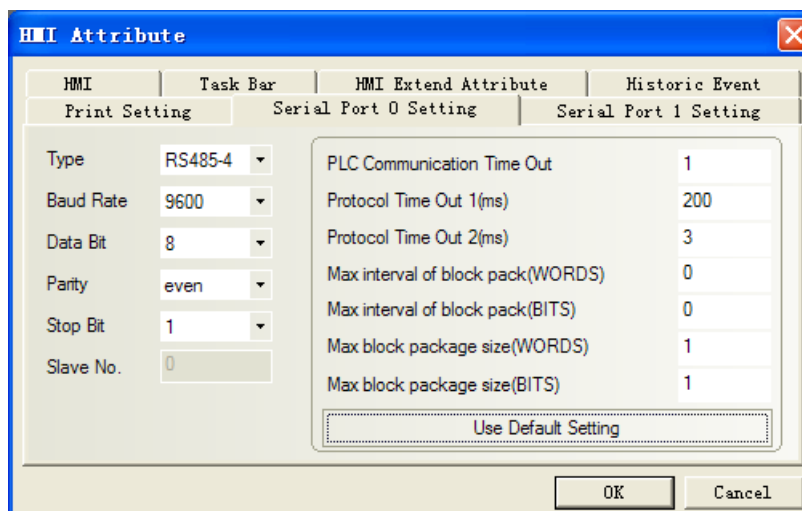

EB-MOD2P-01 RS485-2 communication

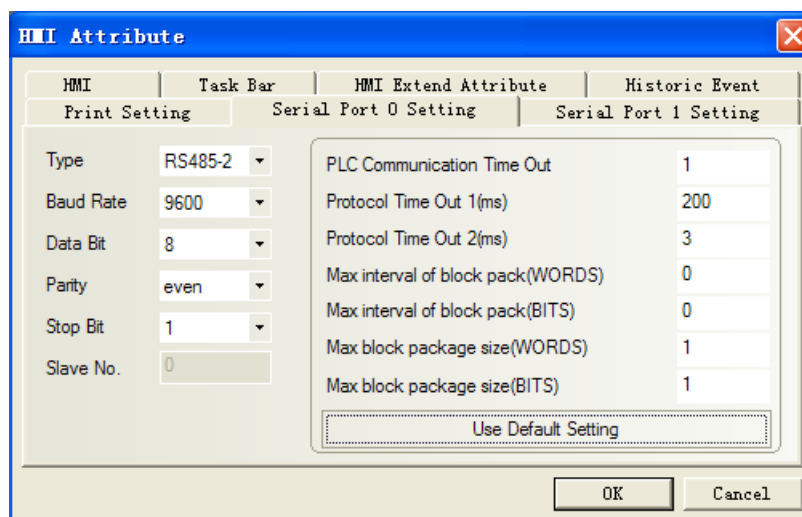

Supported Device

EB-MOD2P-01

Device	Bit Address	Word Address	Format	Notes
Internal/External Output bit	0X1-60	-----	DDDDD	
Internal/External Input bit	1X1-60	-----	DDDDD	
Data Register bit	3X_bit1-60	-----	DDDDD	
Data Register bit	4X_bit1-60	-----	DDDDD	
Simulate Input Register bit	-----	3X1-60	DDDDD	
Data Register	-----	4X1-60	DDDDD	
Data Register	-----	5X1-60	DDDDD	
Data Register	-----	6X1-60	DDDDD	
Data Register	-----	3X-DINV 1-60	DDDDD	
Data Register	-----	4X-DINV 1-60	DDDDD	

Note: The correspondence between the device of EV5000 and the s7-300 software, as follows:

4X-DINV-----PID
 e.g.: 4X-DINV1-----PID256 4X-DINV3-----PID260

3X-DINV-----PQD
 e.g.: 3X-DINV1-----PQD256 3X-DINV3-----PQD260

4X -----PIW
 e.g.: 4X1 -----PIW256 4X2-----PIW258

3X-----PQW
 e.g.: 3X1-----PQW256 3X2-----PQW258

0X-----I
 e.g.: 0X1-----I0.0 0X9-----I1.0

1X-----Q
 e.g.: 1X1-----Q0.0 1X9-----Q1.0

4X_BIT -----PIW (binary)
 e.g.: 4X_BIT1.0~~1.15-----PIW256 (binary)

3X_BIT-----PQW (binary)
 e.g. : 3X_BIT1.0~~1.15-----PQW256 (binary)

PLC software setting

Setup the GSD in the S7-300 software

Procedure :

- (1) .Close all stations in "HW Config".
- (2) .And select "option"-->"setup GSD".
- (3) . In the "installation *.GSD file" dialog box, select Source: folders contain *. GSD file, or the STEP 7 project contain *. GSD file
- (4) .Select one or more files from *.GSD file list, and then click on "install" button.

Copy the icon (. BMP file) to the relevant path, such as BRIDGE product: Bitmap_Device = "EVIEW", that copy the "EVIEW" BMP file to the relevant path: c:\siemens\step7\s7data\nsbmp or c:\siemens\cpbv51\bitmaps

After installation, you can find the appropriate symbol in "PROFIBUS DP\GATWAY".

Project configuration

- (1) Use the guide to set up projects in the s7-300 software.
- (2) Double click "DP" of "HW Config"->attribute->new

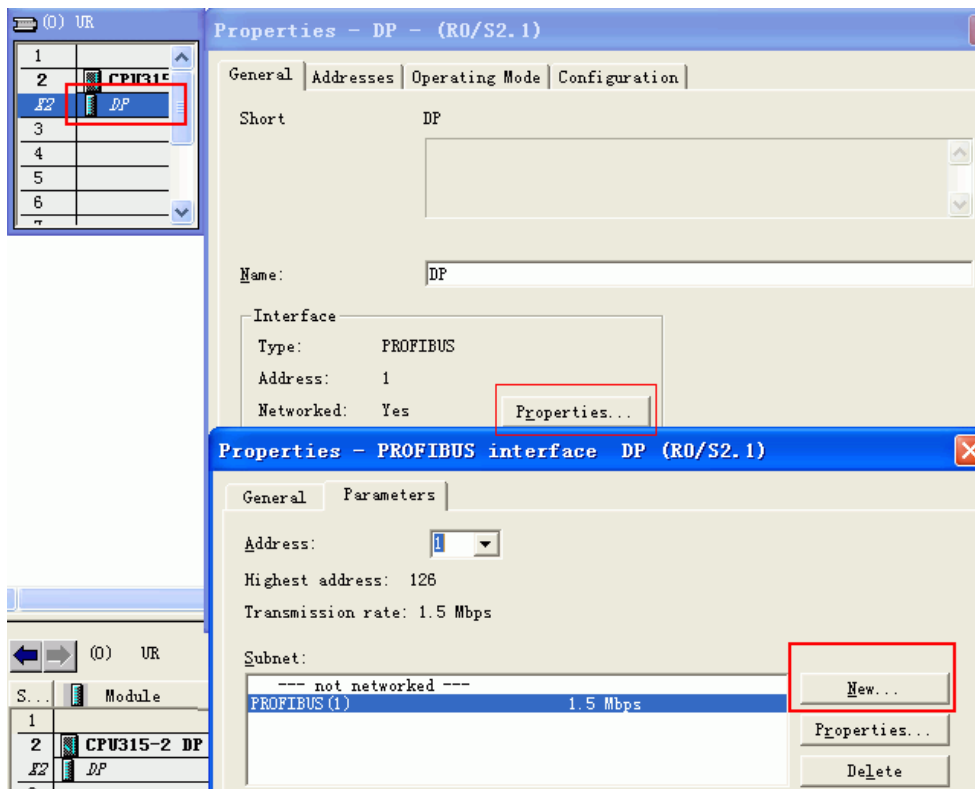

(3) After press “ok”, and then give a connection as follows:

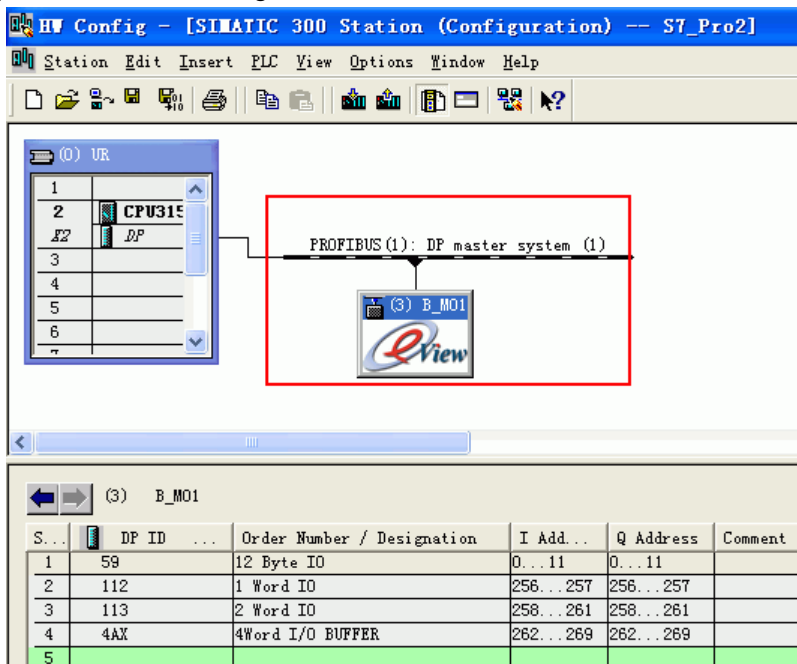

Note: the address of DP can't be the same as MPI's .Double click the address number to change it.

(4) Double click “GATEWAY”->"eview"->"B_MO1"to extend device.

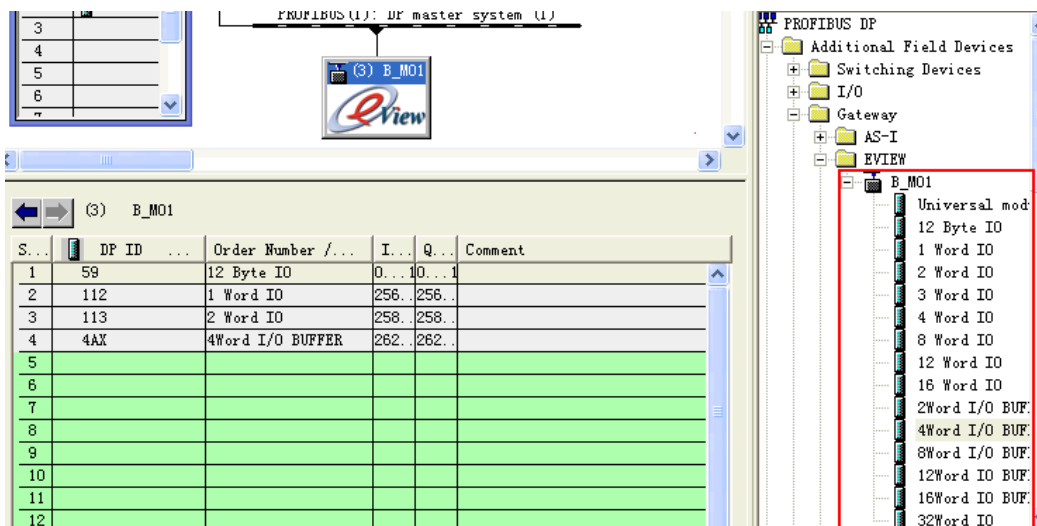

Note: for project configuration of BRIDGE, you must configure DI/D0 resource of 12 bytes firstly. AI/AO is optional.

(5) Must Use OB82,OB86,OB100,OB121,OB122 in the ladder program of the external device, otherwise you need to manually operate the RUN switch of the external device as “RUN,STOP,RUN” in this order upon restart the display or PLC. When you use those special OB block, the communication will be automatically recovered even if you restart the display or PLC.

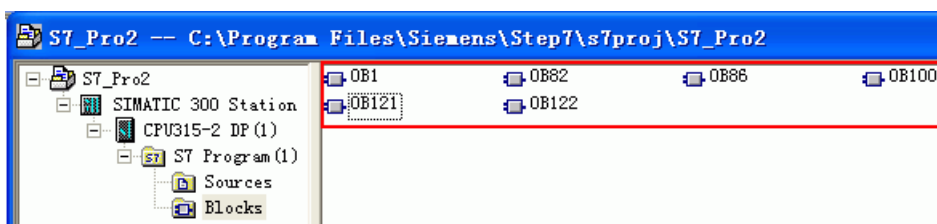

(6) Save and compile, and download to module, then the light of profibus is on.

(7) After configuration, and then you can program.

Bus Bridge setting:

(1) Setting ID of Profibus by switching 8-bit Dip(DIP1 is lowest bit, DIP8 is highest bit),range is from 3 to 125;

ID must be the same as its configuration in Siemens software. As above picture for example, setting is “3”, that the switch DIP1 and DIP2 on the panel of profibus are set ON, others are OFF.

(2) Profibus support baudrate as follows: 9.6Kbit/s, 19.2Kbit/s, 45.45Kbit/s, 93.75Kbit/s, 187.5Kbit/s, 0.5Mbit/s, 1.5Mbit/s, 3Mbit/s, 6Mbit/, 12Mbit/s, and interface is automatically adaptive.

(3) A cable (purple),connect DP interface of s7-300 and bus bridge of profibus. Two sides have active terminal resistors; Switch on the s7-300 PLC is off, on the busbridge is on.

(4) Setting baudrate of modbus by switching DIP1-3 of modbus ID port, support 8 kinds of baudrate .Setting as follows:

1	2	3	Baud
OFF	OFF	OFF	1200
ON	OFF	OFF	2400
OFF	ON	OFF	4800
ON	ON	OFF	9600
OFF	OFF	ON	19200

ON	OFF	ON	38400
OFF	ON	ON	57600
ON	ON	ON	115200

(5) Setting station number of modbus by switching DIP4-8 of modbus ID port ,support 1 to 30 kinds of station number(DIP4 is lowest bit,DIP8 is highest bit, if DIP4 is on and DIP5~8 is off, it means station number is 00001,that is No. 1 station).

Cable Diagram

RS232 communication cable

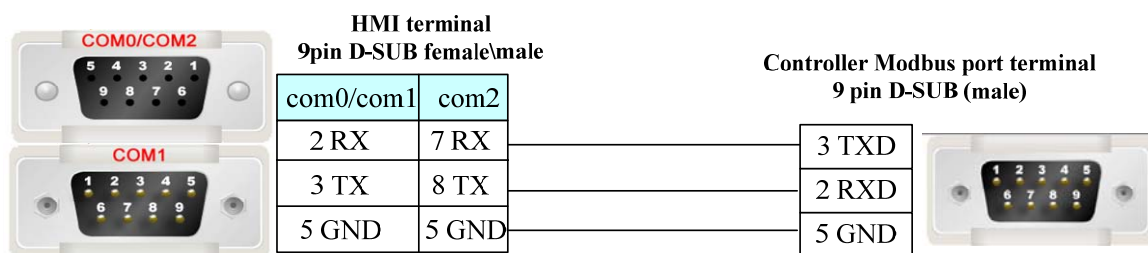

RS485-4 communication cable

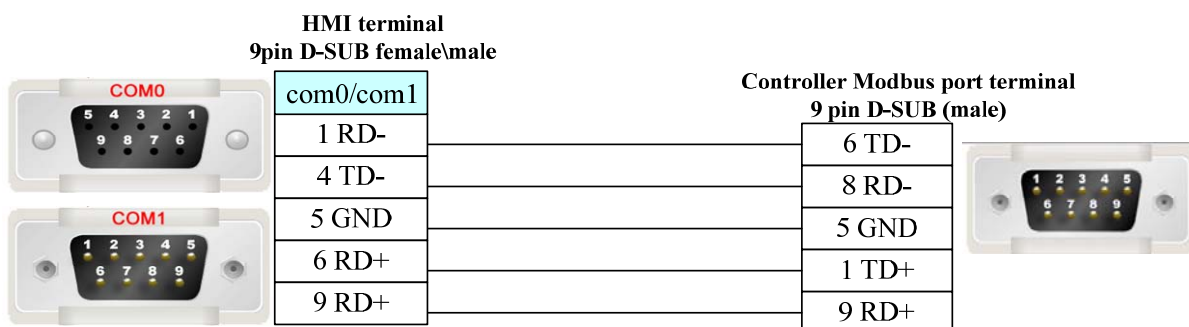

RS485-2 communication cable

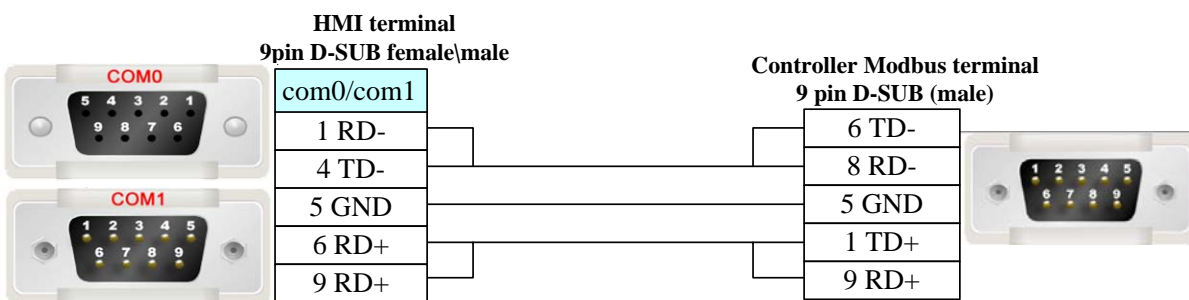

ENDA

Serial Communication

Series	CPU	Link Module	Driver
ENDA devices	ELC	RS485-2 on the CPU unit	ENDA Controller/PLC Devices
	ETC	RS485-2 on the CPU unit	
	EUC	RS485-2 on the CPU unit	
	EPC	RS485-2 on the CPU unit	
	EDP	RS485-2 on the CPU unit	

System configuration

Series	CPU	Link Module	COMM Type	Parameter	Cable
ENDA devices	ELC	RS485-2 on the CPU unit	RS485	Setting	Your owner cable
	ETC	RS485-2 on the CPU unit	RS485		
	EUC	RS485-2 on the CPU unit	RS485		
	EPC	RS485-2 on the CPU unit	RS485		
	EDP	RS485-2 on the CPU unit	RS485		

Communication Setting

ENDA Devices:Default communication:9600, 8, 1, none; station: 1

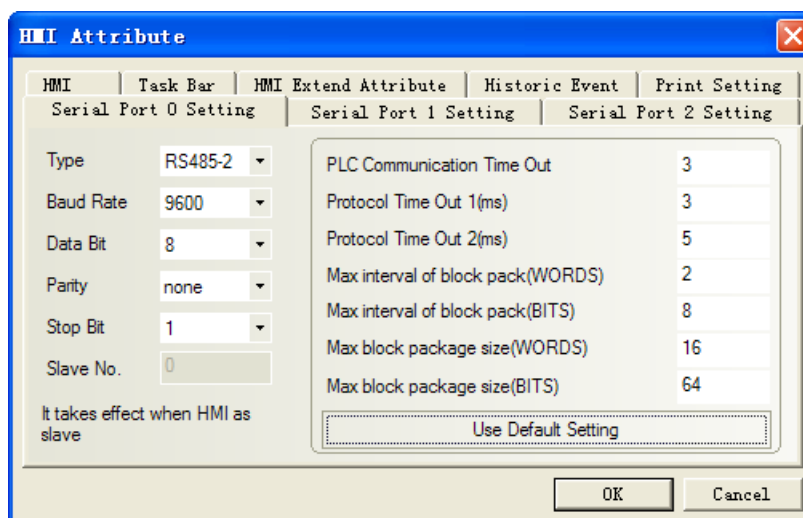

Supported Device

ENDA PLC Devices

Device	Bit Address	Word Address	Format	Notes
Output Relay	MB 0-65535	-----	DDDDD	
Input Relay (read only)	IP 0-65535	-----	DDDDD	

Output Register	-----	MW 0-65535	DDDDD	
Input Register (read only)	-----	IR 0-65535	DDDDD	

ENDA Controller Devices

Device	Bit Address	Word Address	Format	Notes
Coils	Coils 0-65535	-----	DDDDD	
Discrete input (read only)	DI 0-65535	-----	DDDDD	
Holding Registers	-----	HR 0-65535	DDDDD	
Input Register (read only)	-----	IR 0-65535	DDDDD	

Cable Diagram

RS485 communication cable

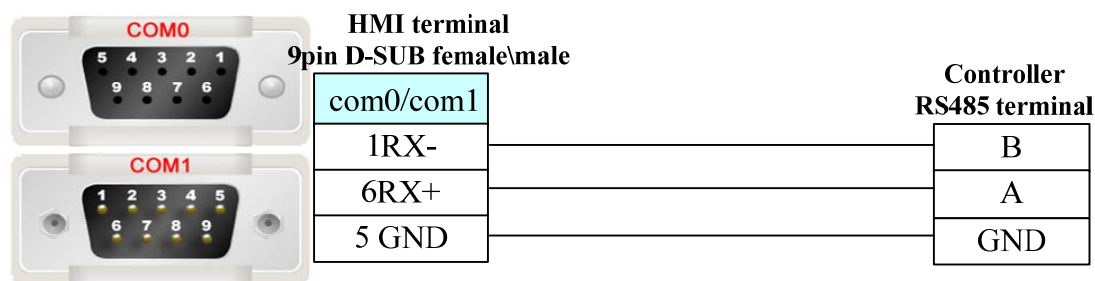

Emerson NetWork Power

Serial Communication

Series	CPU	Link Module	Driver
Emerson Ec10	Ec10-1006BRA	RS232 on the CPU unit	Emerson EC10
Emerson Ec20	Ec20-2012BRA Ec20-3232BRA	RS232 on the CPU unit	Emerson EC20

System configuration

Series	CPU	Link Module	COMM Type	Parameter	Cable
Emerson Ec10	Ec10-1006BRA	RS232 on the CPU unit	RS232	Setting	Your owner cable
		RS485 on port1	RS485-2	Setting	Your owner cable
Emerson Ec20	Ec20-2012BRA	RS232 on the CPU unit	RS232	Setting	Your owner cable
		RS485 on port1	RS485-2	Setting	Your owner cable
	Ec20-3232BRA	RS232 on the CPU unit	RS232	Setting	Your owner cable
		RS485 on port1	RS485-2	Setting	Your owner cable

Communication Setting

Emerson Ec10 RS232 communication

HMI Attribute			
HMI	Task Bar	HMI Extend Attribute	Historic Event
Print Setting		Serial Port 0 Setting	Serial Port 1 Setting
Type	RS232	PLC Communication Time Out	1
Baud Rate	19200	Protocol Time Out 1(ms)	3
Data Bit	8	Protocol Time Out 2(ms)	3
Parity	even	Max interval of block pack(WORDS)	2
Stop Bit	1	Max interval of block pack(BITS)	8
Slave No.	1	Max block package size(WORDS)	16
		Max block package size(BITS)	64
Use Default Setting			
		OK	Cancel

Emerson Ec20 RS232 communication

HMI Attribute			
HMI	Task Bar	HMI Extend Attribute	Historic Event
Print Setting		Serial Port 0 Setting	Serial Port 1 Setting
Type	RS232	PLC Communication Time Out	1
Baud Rate	19200	Protocol Time Out 1(ms)	3
Data Bit	8	Protocol Time Out 2(ms)	3
Parity	even	Max interval of block pack(WORDS)	2
Stop Bit	1	Max interval of block pack(BITS)	8
Slave No.	1	Max block package size(WORDS)	16
		Max block package size(BITS)	64
Use Default Setting			
		OK	Cancel

Emerson Ec10 RS485-2 communication

HMI Attribute			
HMI	Task Bar	HMI Extend Attribute	Historic Event
Print Setting		Serial Port 0 Setting	Serial Port 1 Setting
Type	RS485-2	PLC Communication Time Out	1
Baud Rate	19200	Protocol Time Out 1(ms)	3
Data Bit	8	Protocol Time Out 2(ms)	3
Parity	even	Max interval of block pack(WORDS)	2
Stop Bit	1	Max interval of block pack(BITS)	8
Slave No.	1	Max block package size(WORDS)	16
		Max block package size(BITS)	64
Use Default Setting			
		OK	Cancel

Emerson Ec20 RS485-2 communication

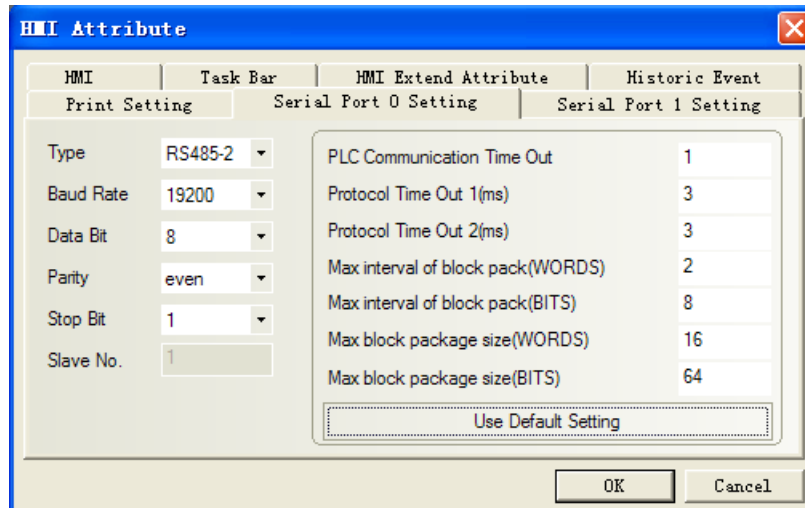

Note: Communication with port1, you must set the system configuration in the programming software first.

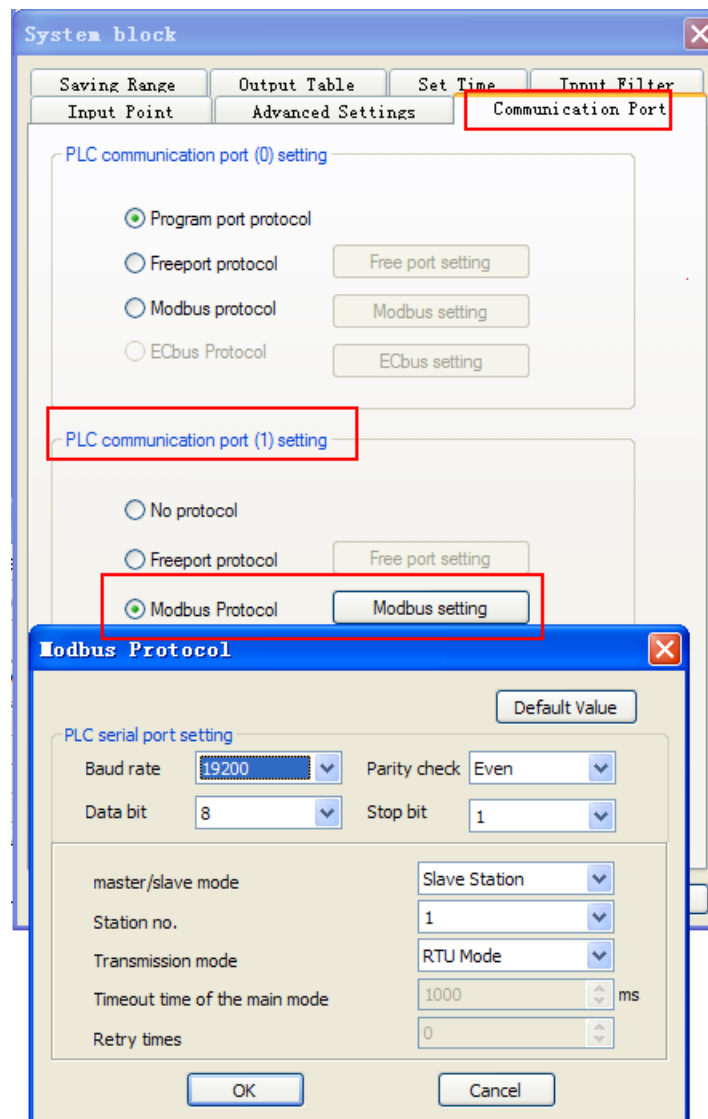

Supported Device

Emerson Ec10

Device	Bit Address	Word Address	Format	Notes
Output Relay	X000-377	-----	OOO	
Input Relay	Y000-377	-----	OOO	
Internal Relay	M0000-1999	-----	DDDD	
Special Relay	SM000-255	-----	DDD	
Step Relay	S000-991	-----	DDD	
Timer Relay	T000-255	-----	DDD	
Counter Relay	C000-255	-----	DDD	
Data register	-----	D0000-7999	DDDD	
Special Register	-----	SD000-255	DDD	
Index Register	-----	Z00-15	DD	
Timer	-----	T000-255	DDD	
Counter	-----	C000-199	DDD	
Counter(double word)	-----	C_Double200-255	DDD	
Data register(double word)	-----	D_Double0000-7999	DDDD	
Special Register(double word)	-----	SD_Double000-127	DDD	

Emerson Ec20

Device	Bit Address	Word Address	Format	Notes
Output Relay	X000-377	-----	OOO	
Input Relay	Y000-377	-----	OOO	
Internal Relay	M0000-1999	-----	DDDD	
Special Relay	SM000-255	-----	DDD	
Step Relay	S000-991	-----	DDD	
Timer	T000-255	-----	DDD	
Counter	C000-255	-----	DDD	
Data register	-----	D0000-7999	DDDD	
Special Register	-----	SD000-255	DDD	
Index Register	-----	Z00-15	DD	
Timer	-----	T000-255	DDD	
Counter	-----	C000-199	DDD	
Counter(double word)	-----	C_Double200-255	DDD	
Data register(double word)	-----	D_Double0000-7999	DDDD	
Special Register(double word)	-----	SD_Double000-125	DDD	

Cable Diagram**Emerson RS232 communication**

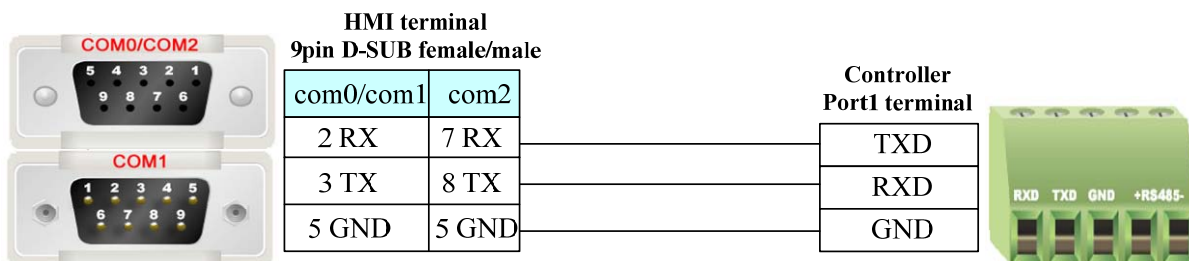
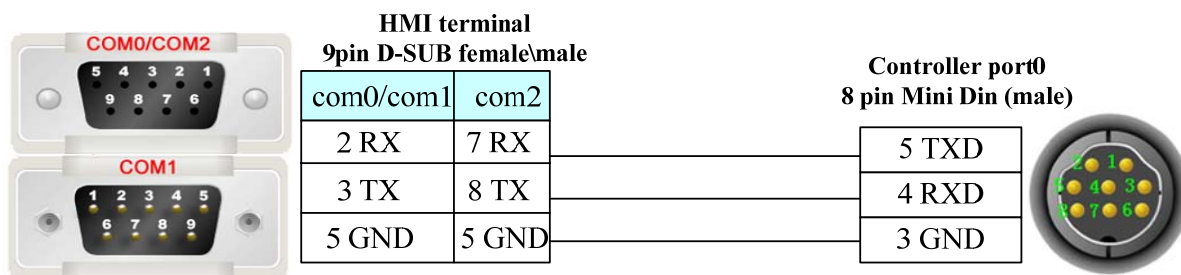

Emerson RS485-2 communication

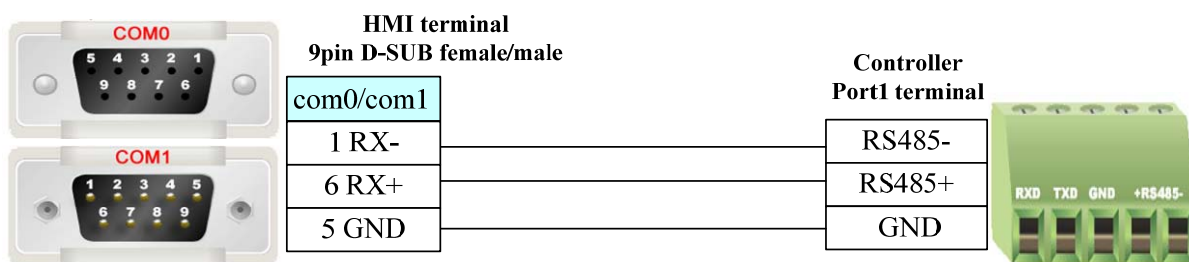

Epower

Serial Communication

Series	CPU	Link Module	Driver
Epower	Epower	CPU Direct	EPower
			Epower Slave

System configuration

Series	CPU	Link Module	COMM Type	Parameter	Cable
Epower	Epower	CPU Direct	RS232	Setting	Your owner cable
				Setting	Your owner cable

Communication Setting

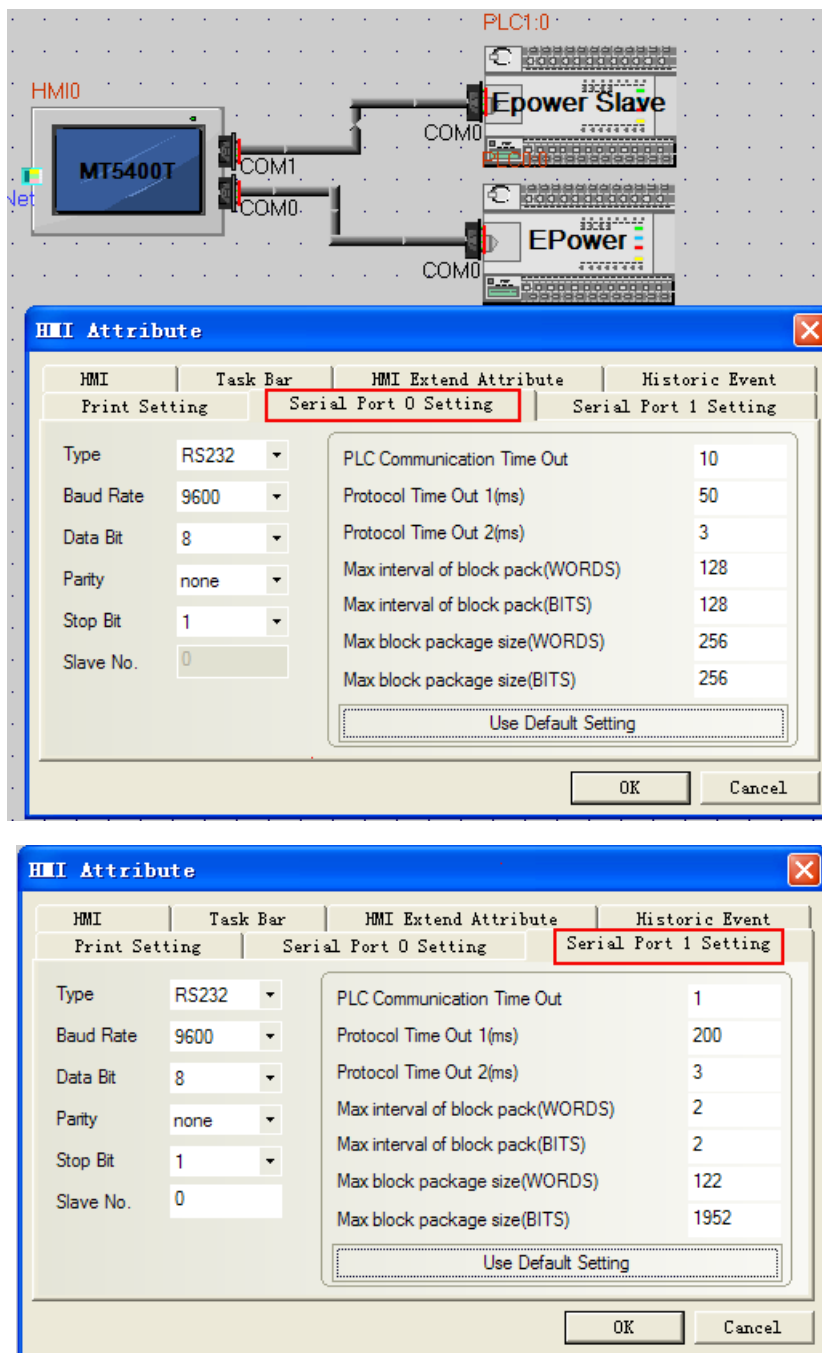

Supported Device

Device	Bit Address	Word Address	Format	Notes
UPSSet	UPSSet1-6	-----	DDDDD	
UPSPanel	UPSPanel0-9	-----	DDDDD	
UPSDData	-----	UPSDData0-70	DDDD	
UPSDisp	-----	UPSDisp0	DDDDD	
UPSCCommand	-----	UPSCCommand0-52	DDDDD	
UPSText	-----	UPSText0-1	DDDDD	

Slave driver notes:

1. Transmit the device value to LW, LB by timer; refer to the addr table for details.
2. UPSCommand must use with UPSSet、 macro;
3. UPSDisp must use with UPStextr、 UPSPanel、 macro.

Epower HMI project notes:

1. The project must have UPSData0 device, otherwise the data accuracy will be affected; Suggest to put UPSData0 device in the public window.
2. LW.B indicates the bits of UPSData

Cable Diagram

COM0 connect to ups communication board

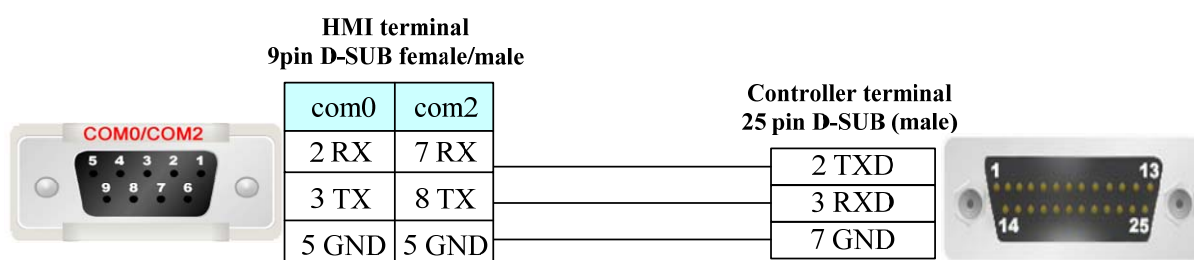

COM1 connect to King software or comdebug tool

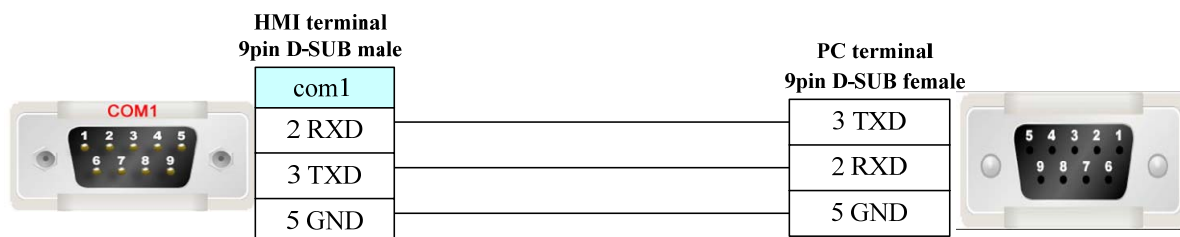

eView Master & Eview Slave(Master/Slave Protocol Connection)

Serial Communication

Series	CPU	Link Module	Driver
Eview Master			Eview Master
Eview Slave			Eview Slave

System configuration

Series	CPU	Link Module	COMM Type	Parameter	Cable
Eview Master				Setting	Your owner cable
Eview Slave				Setting	Your owner cable

Supported Device

Device	Bit Address	Word Address	Format	Notes
	B0 - 8999	-----	DDDD	
	-----	W0 - 8999	DDDD	

Communication Setting

VIEW MASTER

HMI Attribute

HMI	Task Bar	HMI Extend Attribute	Historic Event
Print Setting	Serial Port 0 Setting	Serial Port 1 Setting	

Type: RS232
 Baud Rate: 9600
 Data Bit: 8
 Parity: even
 Stop Bit: 1
 Slave No.: 0

PLC Communication Time Out: 1
 Protocol Time Out 1(ms): 50000
 Protocol Time Out 2(ms): 0
 Max interval of block pack(WORDS): 2
 Max interval of block pack(BITS): 2
 Max block package size(WORDS): 56
 Max block package size(BITS): 128

Use Default Setting

OK Cancel

VIEW SLAVE

HMI Attribute

HMI	Task Bar	HMI Extend Attribute	Historic Event
Print Setting	Serial Port 0 Setting	Serial Port 1 Setting	

Type: RS232
 Baud Rate: 9600
 Data Bit: 8
 Parity: even
 Stop Bit: 1
 Slave No.: 1

PLC Communication Time Out: 1
 Protocol Time Out 1(ms): 50000
 Protocol Time Out 2(ms): 0
 Max interval of block pack(WORDS): 2
 Max interval of block pack(BITS): 2
 Max block package size(WORDS): 56
 Max block package size(BITS): 128

Use Default Setting

OK Cancel

Cable Diagram

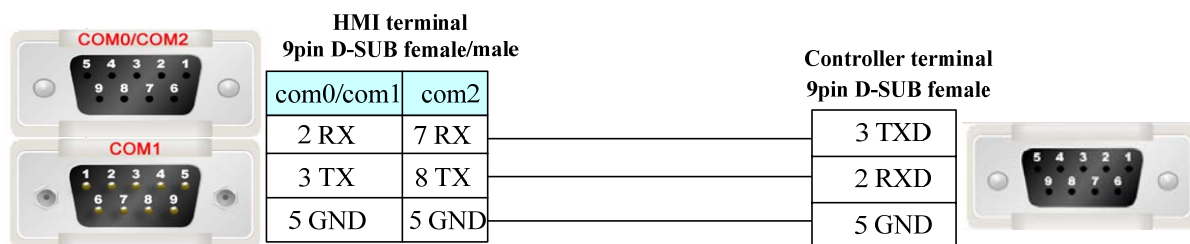

Facon Corporation

Serial Communication

c	CPU	Link Module		Driver	
FBs	FBs-10MA/MC	RS232 on the CPU unit	Port 0	Facon FB Modbus RTU	
	FBs-14MA/MC	FBS-CB25-3	Port 1		
	FBs-20MA/MC		Port 2		
	FBs-24MA/MC				
	FBs-32MA/MC				
	FBs-40MA/MC				
	FBs-60MA/MC				
	FBs-20MN				
	FBs-32MN				
FBs-44MN					
FBe/FBn	FBe-20MA	CPU unit	Port 0		
	FBe-28MA				
	FBe-40MA				
	FBe-20MC	CPU unit	Port 0		
	FBe-28MC		Port 1		
	FBe-40MC		Port 2		
	FBn-19MCT	FB-DTBR			
	FBn-26MCT	FB-DTBR-E			
FBn-36MCT					

System configuration

Driver	Series	CPU	Link Module	COMM Type	Parameter	Cable
FACON FB	FB MA FB MC	FBs-20MAT	RS232 on the CPU unit	RS232	Setting	Your owner cable
			FBS-CB25-3	RS232	Setting	Your owner cable
				RS485	Setting	Your owner cable
Modbus RTU	FB MA FB MC	FBs-20MAT	FBS-CB25-3	RS232	Setting	Your owner cable
				RS485	Setting	Your owner cable

Communication Setting

FACON FB RS232 communication

HMI Attribute			
HMI	Task Bar	HMI Extend Attribute	Historic Event
Print Setting		Serial Port 0 Setting	Serial Port 1 Setting
Type	RS232	PLC Communication Time Out	3
Baud Rate	9600	Protocol Time Out 1(ms)	3
Data Bit	7	Protocol Time Out 2(ms)	3
Parity	even	Max interval of block pack(WORDS)	16
Stop Bit	1	Max interval of block pack(BITS)	32
Slave No.	0	Max block package size(WORDS)	64
		Max block package size(BITS)	256

Use Default Setting

OK Cancel

FBS-CB25-3 module RS485 communication

HMI Attribute				
HMI	Task Bar	HMI Extend Attribute	Historic Event	Print Setting
Serial Port 2 Setting		Serial Port 0 Setting	Serial Port 1 Setting	Extended Memory
Type	RS485-2	PLC Communication Time Out	3	
Baud Rate	9600	Protocol Time Out 1(ms)	3	
Data Bit	7	Protocol Time Out 2(ms)	3	
Parity	even	Max interval of block pack(WORDS)	16	
Stop Bit	1	Max interval of block pack(BITS)	32	
Slave No.	0	Max block package size(WORDS)	64	
		Max block package size(BITS)	256	

It takes effect when HMI as slave

Use Default Setting

OK Cancel

FBS-CB25-3 module communication

Modbus RTU RS232 communication

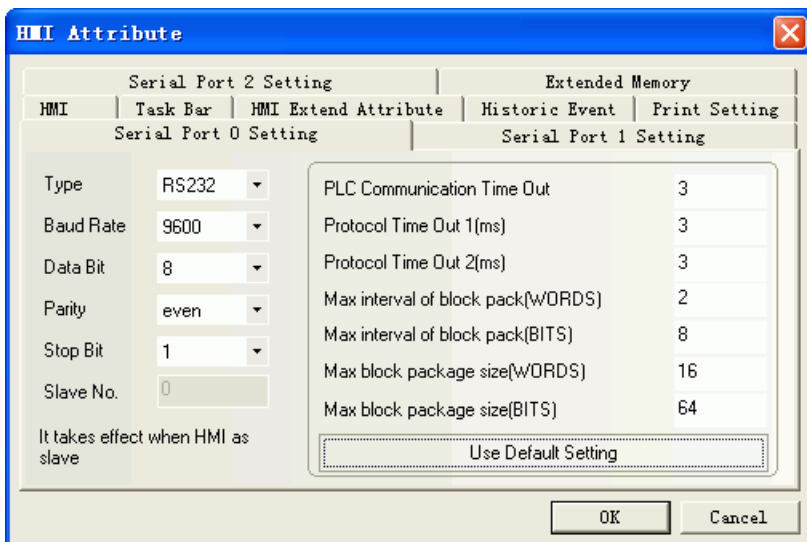

Modbus RTU RS485-2 communication

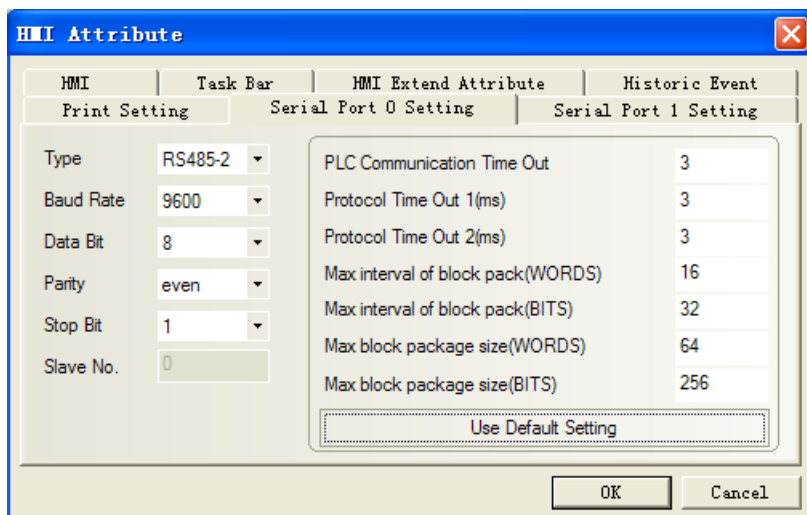

Note: The detailed communication configuration must be the same as the PLC’s port setting.

Supported Device

Device	Bit Address	Word Address	Format	Notes
Input	X0-9999	-----	DDDD	
Output	Y0-9999	-----	DDDD	
Internal Relay	M0-9999	-----	DDDD	
Step Relay	S0-9999	-----	DDDD	
Timer Relay	T0-9999	-----	DDDD	
Counter Relay	C0-9999	-----	DDDD	
Data Register	-----	HR0-9999	DDDD	
Data Register	-----	DR0-9999	DDDD	
Timer	-----	TMR0-9999	DDDD	
Counter	-----	CTR0-199	DDD	

Double word Counter Register	-----	DRC200-255	DDD	
------------------------------	-------	------------	-----	--

Note: HR register corresponds to the “R” register of the PLC;
 DR register corresponds to the “D” register of the PLC;
 TMR register corresponds to the “T” register of the PLC;
 CTR register corresponds to the “C” register of the PLC;
 DRC register corresponds to the “C(32)” register of the PLC, e.g.: DRC200==C200

Cable Diagram

FB RS232 communication cable

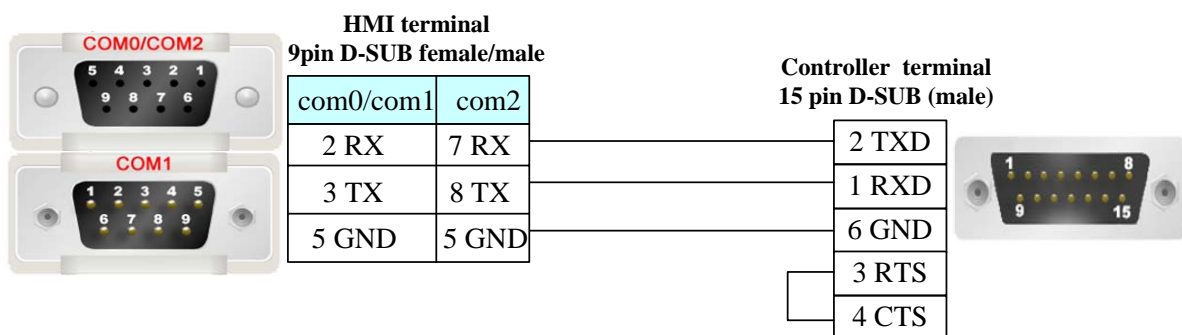
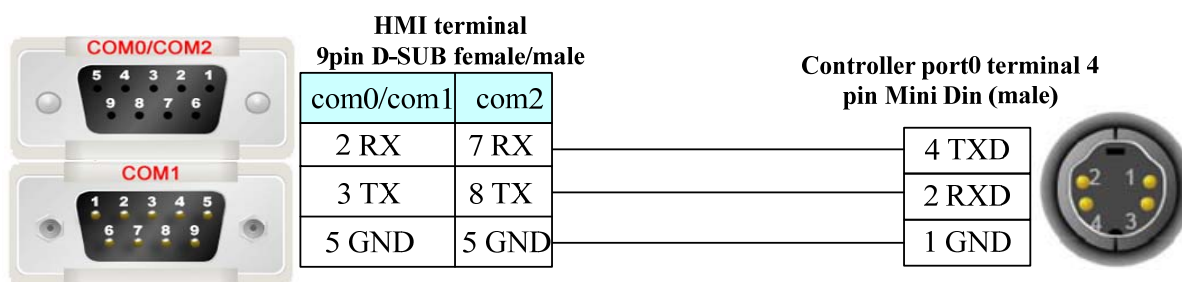

FBS-CB25-3 module communication

RS232 communication cable

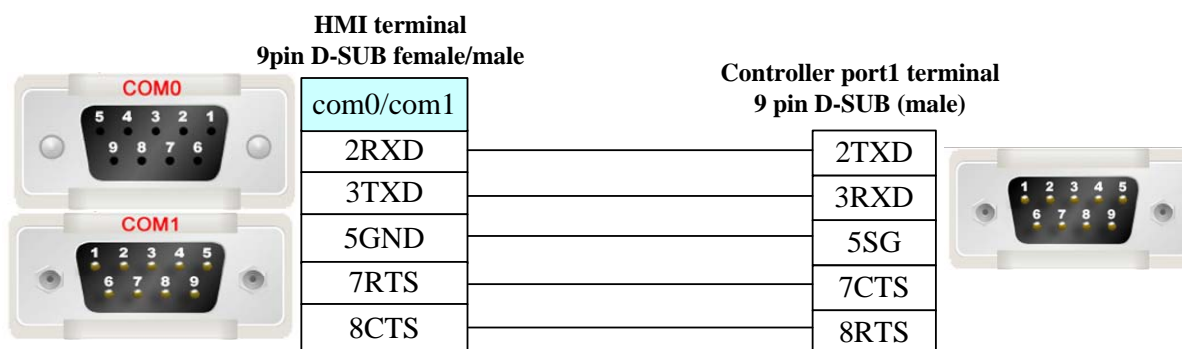

RS485 communication cable

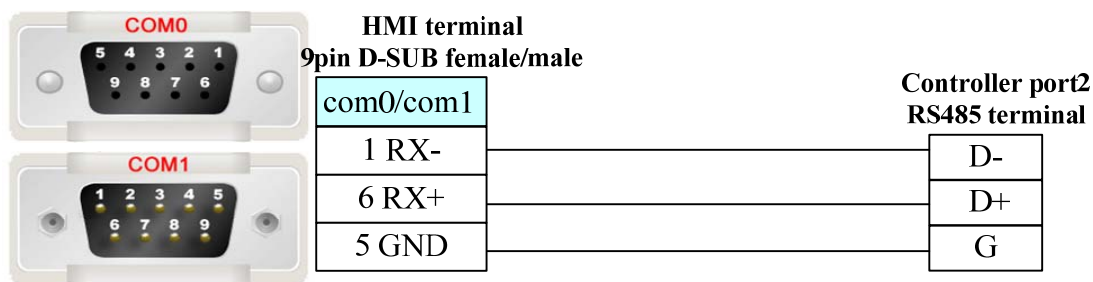

Fuji SPB

Serial Communication

Series	CPU	Link Module	Driver
SPB	NW0P20T-31	RS485 interface on the CPU	Fuji SPB
NB	NB2U24R-11	RS485 interface on the CPU	

System configuration

Series	CPU	Link Module	Ethernet Type	Parameter	Cable
SPB	NW0P20T-31	RS485 interface on the CPU	RS485-4	Setting	Your owner cable
NB	NB2U24R-11	RS485 interface on the CPU	RS485-4		

Communication Setting

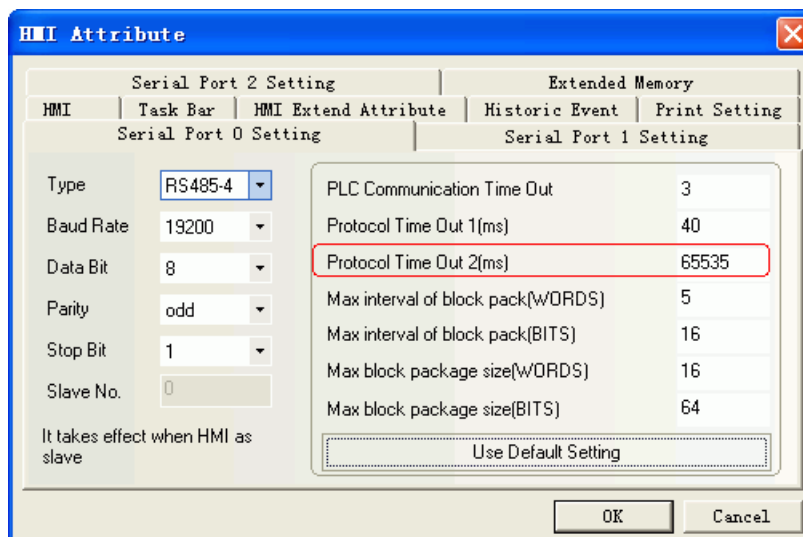

Note: When PLC is protected by password, protocol time out is 65535, and the register is read only. If you want to make the register writable, you must let the protocol time out 2 equal the PLC password.

Example: PLC password is 1234, and then you make the protocol time out 2 to be 1234.

PLC password is 0010, and then you make the protocol time out 2 to be 10.

Supported Device

SPB

Device	Bit Address	Word Address	Format	Notes
Data register	D 0~6FFF	-----	HHH.H	
Special relay	M_special 0~1FF	-----	HHH	
Counter contact	C 0~FF	-----	HH	
Timer contact	T 0~1FF	-----	HHH	
Keep relay	L 0~FFF	-----	HHH	
Auxiliary relay	M 0~FFF	-----	HHH	
Output relay	Y 0~3FF	-----	HHH	
Input relay	X 0~3FF	-----	HHH	
Timer contact	-----	TW 0~3FF	HHH	
Counter contac	-----	CW 0~FF	HH	
Data register	-----	DW 0~6FF	HHH	
Special register	-----	DW_special 0~1FF	HHH	
Link register(0 slot)	-----	W0 0~7FF	HH	
Link register(1 slot)	-----	W1 0~7FF	HHH	
Link register(2 slot)	-----	W2 0~7FF	HHH	
Link register(3 slot)	-----	W3 0~7FF	HHH	
Link register(4 slot)	-----	W4 0~7FF	HHH	
Link register(5 slot)	-----	W5 0~7FF	HHH	
Link register(6 slot)	-----	W6 0~7FF	HHH	
Link register(7 slot)	-----	W7 0~7FF	HHH	

Note: M_special address: 8000 in the PLC corresponds to 0 in the HMI.

DW_special address: 8000 in the PLC corresponds to 0 in the HMI.

NB

Device	Bit Address	Word Address	Format	Notes
Data register	D 0~3FF	-----	HHH.H	
Special relay	M_special 0~1FF	-----	HHH	
Counter contact	C 0~1F	-----	HH	
Timer contact	T 0~1F	-----	HHH	
Keep relay	L 0~1FF	-----	HHH	
Auxiliary relay	M 0~3FF	-----	HHH	
Output relay	Y 0~3F	-----	HHH	
Input relay	X 0~3F	-----	HHH	Read only
Timer contact	-----	TW 0~1F	HHH	
Counter contact	-----	CW 0~1F	HH	

Data register	-----	DW 0~3F	HHH	
Special register	-----	DW_special 0~1FF	HHH	

Cable Diagram

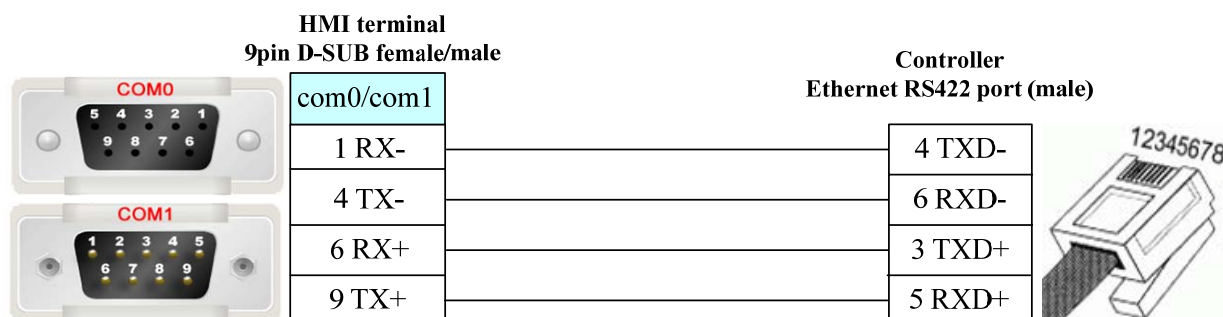

GE Fanuc Automation Inc.

Serial Communication

Series	CPU	Link Module	Driver
GE Fanuc Series 90-30	IC693CPU311	Serial Connector on Power Supply	GE Fanuc Series SNP
	IC693CPU313		
	IC693CPU321		
	IC693CPU323		
	IC693CPU331		
	IC693CPU340		
	IC693CPU341		
	IC693CPU350		
	IC693CPU351		
	IC693CPU352		
	IC693CPU360		
	IC693CPU363		
	IC693CPU364		
	IC693CPU374		
	IC693CSE311		
	IC693CSE313		
	IC693CSE323		
	IC693CSE331		
	IC693CSE340		
	IC693CPU313		
	IC693CPU321		
	IC693CPU323	IC693CMM311	
	IC693CPU331		

	IC693CPU340 IC693CPU341 IC693CPU350 IC693CPU360 IC693CPU364		
	IC693CPU351 IC693CPU352 IC693CPU363	Connector on Power Supply	
		Port1 on CPU unit	
		Port2 on CPU unit	
	IC693CPU374	IC693CMM311	
		Port on Power Supply	
VersaMax Series	CPU001/002/005 CPUE05	RS232 on port1	
		RS485 on port2	
VersaMax Micro & Nano Series	IC200UAL004/005/006 IC200UDD110/120/212 IC200UDR005/006/010	RS232 on port1	
	IC200UAA007 IC200UAR028	RS485 on port2	

System configuration

Series	CPU	Link Module	COMM Type	Parameter	Cable
GE Fanuc Series 90-30	IC693CPU374	RS485 on the CPU unit	RS232	Setting	Your owner cable
			RS485-4	Setting	Your owner cable
		IC693CMM311	RS232	Setting	Your owner cable
			RS485-4	Setting	Your owner cable
VersaMax Series	CPU001/002/005 CPUE05	RS232 on port1	RS232	Setting	Your owner cable
		RS485 on port2	RS485-4	Setting	Your owner cable
VersaMax Micro & Nano Series	IC200UAL004/005/006 IC200UDD110/120/212 IC200UDR005/006/010	RS232 on port1	RS232	Setting	Your owner cable
	IC200UAA007 IC200UAR028	RS485 on port2	RS485-4	Setting	Your owner cable

Communication Setting

GE Fanuc Series SNP RS232 Communication

The screenshot shows the 'HMI Attribute' dialog box with the 'Serial Port 0 Setting' tab selected. The 'Type' is set to 'RS232'. The 'Baud Rate' is '19200', 'Data Bit' is '8', 'Parity' is 'odd', 'Stop Bit' is '1', and 'Slave No.' is '1'. The 'PLC Communication Time Out' is '1'. The 'Protocol Time Out 1(ms)' is '1', and 'Protocol Time Out 2(ms)' is '0'. The 'Max interval of block pack(WORDS)' is '2', and 'Max interval of block pack(BITS)' is '2'. The 'Max block package size(WORDS)' is '16', and 'Max block package size(BITS)' is '16'. There is a 'Use Default Setting' button and 'OK' and 'Cancel' buttons at the bottom.

HMI	Task Bar	HMI Extend Attribute	Historic Event
Print Setting	Serial Port 0 Setting	Serial Port 1 Setting	
Type	RS232	PLC Communication Time Out	1
Baud Rate	19200	Protocol Time Out 1(ms)	1
Data Bit	8	Protocol Time Out 2(ms)	0
Parity	odd	Max interval of block pack(WORDS)	2
Stop Bit	1	Max interval of block pack(BITS)	2
Slave No.	1	Max block package size(WORDS)	16
		Max block package size(BITS)	16

GE Fanuc Series SNP RS422 Communication

The screenshot shows the 'HMI Attribute' dialog box with the 'Serial Port 0 Setting' tab selected. The 'Type' is set to 'RS485-4'. The 'Baud Rate' is '19200', 'Data Bit' is '8', 'Parity' is 'odd', 'Stop Bit' is '1', and 'Slave No.' is '1'. The 'PLC Communication Time Out' is '1'. The 'Protocol Time Out 1(ms)' is '1', and 'Protocol Time Out 2(ms)' is '0'. The 'Max interval of block pack(WORDS)' is '2', and 'Max interval of block pack(BITS)' is '2'. The 'Max block package size(WORDS)' is '16', and 'Max block package size(BITS)' is '16'. There is a 'Use Default Setting' button and 'OK' and 'Cancel' buttons at the bottom. A note at the bottom left states: 'It takes effect when HMI as slave'.

HMI	Task Bar	HMI Extend Attribute	Historic Event	Print Setting
Serial Port 0 Setting	Serial Port 1 Setting	Serial Port 2 Setting		
Type	RS485-4	PLC Communication Time Out	1	
Baud Rate	19200	Protocol Time Out 1(ms)	1	
Data Bit	8	Protocol Time Out 2(ms)	0	
Parity	odd	Max interval of block pack(WORDS)	2	
Stop Bit	1	Max interval of block pack(BITS)	2	
Slave No.	1	Max block package size(WORDS)	16	
		Max block package size(BITS)	16	

GE SNP-X Protocol RS232 Communication

The screenshot shows the 'HMI Attribute' dialog box with the 'Serial Port 0 Setting' tab selected. The 'Type' is set to 'RS232'. The 'Baud Rate' is '19200', 'Data Bit' is '8', 'Parity' is 'odd', 'Stop Bit' is '1', and 'Slave No.' is '1'. The 'PLC Communication Time Out' is '3'. The 'Protocol Time Out 1(ms)' is '1000', and 'Protocol Time Out 2(ms)' is '3'. The 'Max interval of block pack(WORDS)' is '2', and 'Max interval of block pack(BITS)' is '2'. The 'Max block package size(WORDS)' is '16', and 'Max block package size(BITS)' is '8'. There is a 'Use Default Setting' button and 'OK' and 'Cancel' buttons at the bottom.

HMI	Task Bar	HMI Extend Attribute	Historic Event
Print Setting	Serial Port 0 Setting	Serial Port 1 Setting	
Type	RS232	PLC Communication Time Out	3
Baud Rate	19200	Protocol Time Out 1(ms)	1000
Data Bit	8	Protocol Time Out 2(ms)	3
Parity	odd	Max interval of block pack(WORDS)	2
Stop Bit	1	Max interval of block pack(BITS)	2
Slave No.	1	Max block package size(WORDS)	16
		Max block package size(BITS)	8

GE SNP-X Protocol RS422 Communication

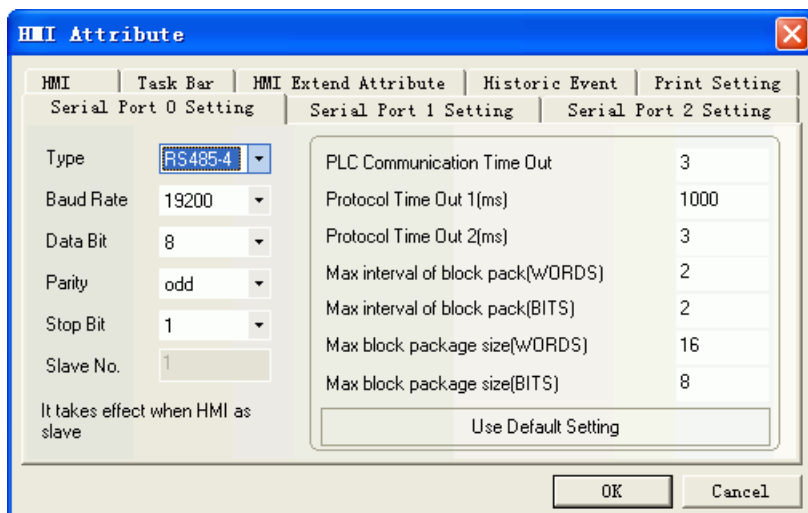

Note: Set matching communication parameter in the Programming software.

Parameters	Values
I/O Scan-Stop:	No
Power Up Mode:	Last
Logic / Configuration From:	RAM
Registers:	RAM
Passwords:	Enabled
Checksum Words:	8
Default Modem Turnaround Time (.01)	0
Default Idle Time (Sec):	10
SNP ID:	1
Switch Run / Stop:	Enabled
Switch Memory Protect:	Disabled
Diagnostics:	Enabled
Fatal Fault Override:	Disabled

Parameters	Values
Port Mode:	SNP
Port Type:	Slave
Data Rate (bps):	19200
Parity:	Odd
Stop Bits:	1
Timeout:	Long
Turnaround Delay (mSec in 10 mSec)	0
SNP ID:	1

Supported Device

Device	Bit Address	Word Address	Format	Notes
System	SC01-32	-----	DD	
System	SB01-32	-----	DD	
System	SA01-32	-----	DD	
System	S01-32	-----	DD	
Temporary	T001-256	-----	DDD	
Internal	M0001-4096	-----	DDDD	
Genius Global	G0001-1280	-----	DDDD	
Output	Q0001-2048	-----	DDDD	
Input	I001-256	-----	DDD	
Analog Output	-----	AQ001-512	DDD	
Analog Input	-----	AI0001-2048	DDDD	
Register	-----	R0001-9999	DDDD	

Cable Diagram

GE Fanuc Series SNP RS232 communication

The communication cable recommended by GE Fanuc Automation

VersaMax series RS232 communication

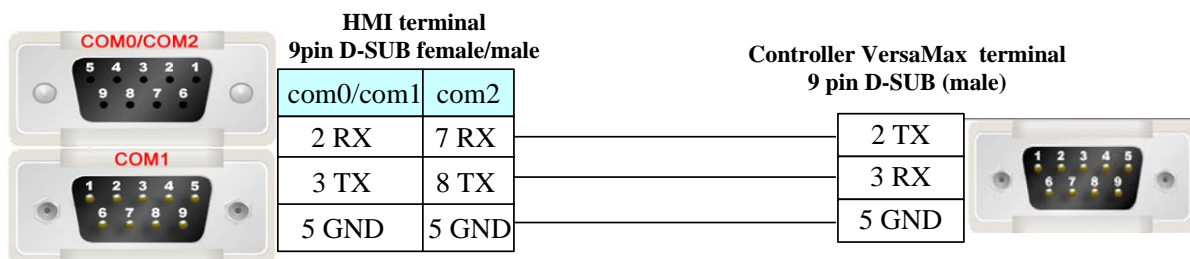

VersaMax Micro & Nano Series RS232 communication

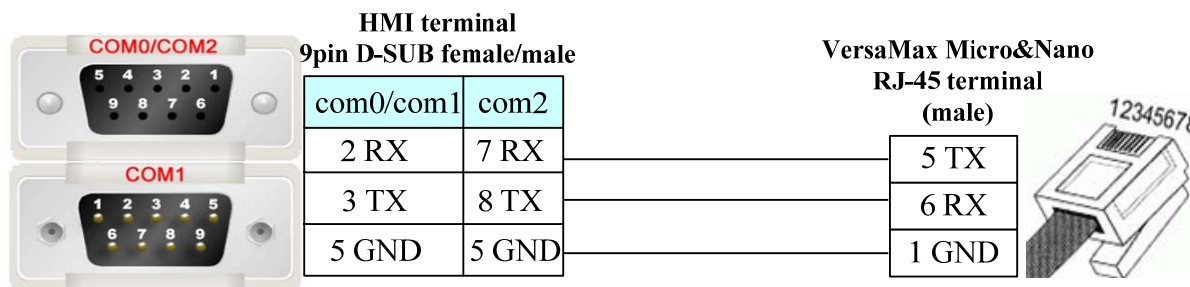

CMM311 RS232 communication

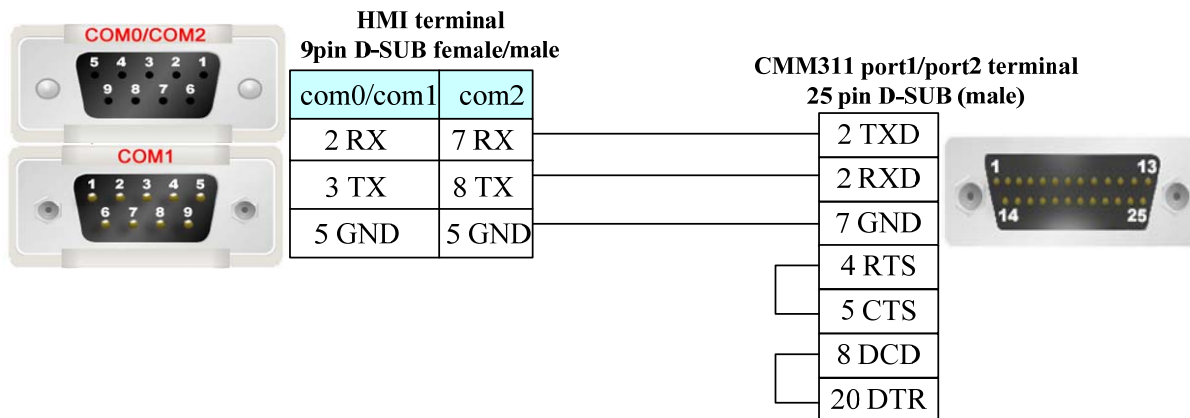

CMM311 RS422 communication

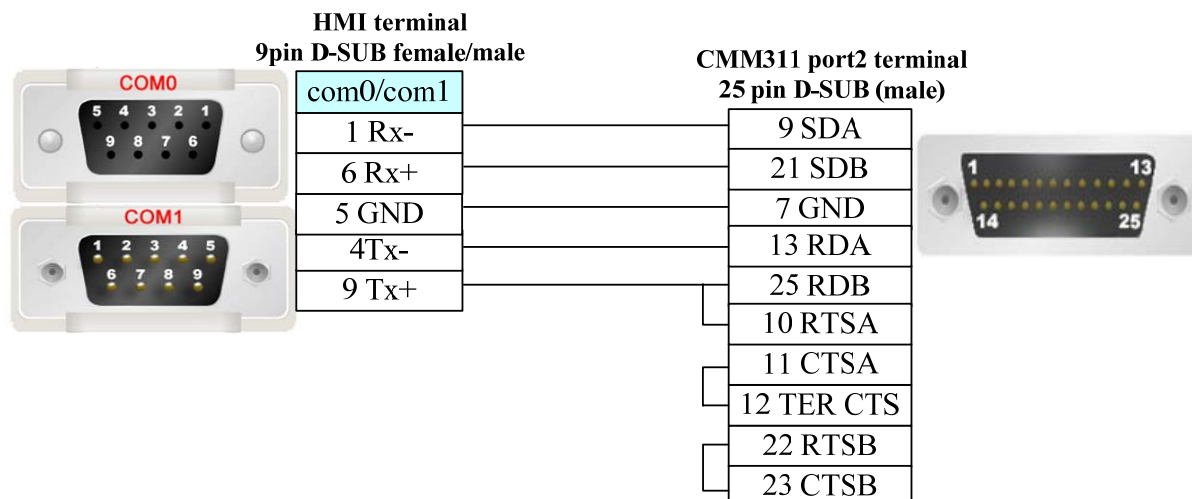

90-30/VersaMax RS422 communication

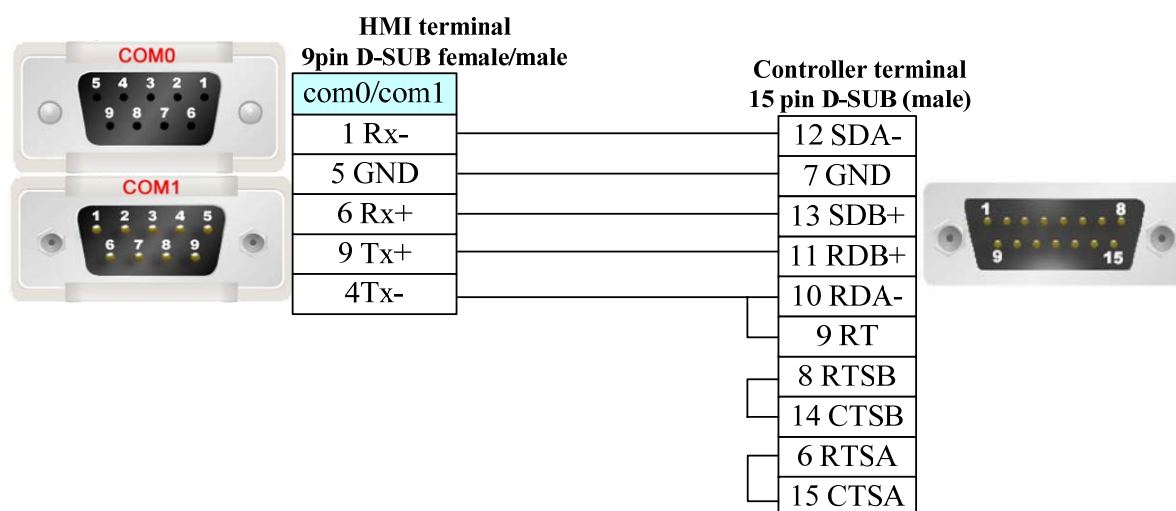

HAIWELL

Serial Communication

Series	CPU	Link Module	Driver
E/S	HW-S16ZA220R	RS232 on com1	Haiwell
		RS485 on com2	

System configuration

Series	CPU	Link Module	COM Type	Parameter	Cable
E/S	HW-S16ZA220R	RS232 on com1	RS232	Setting	Your owner cable
		RS485 on com2	RS485	Setting	Your owner cable

Communication Setting

Haiwell RS232 communication

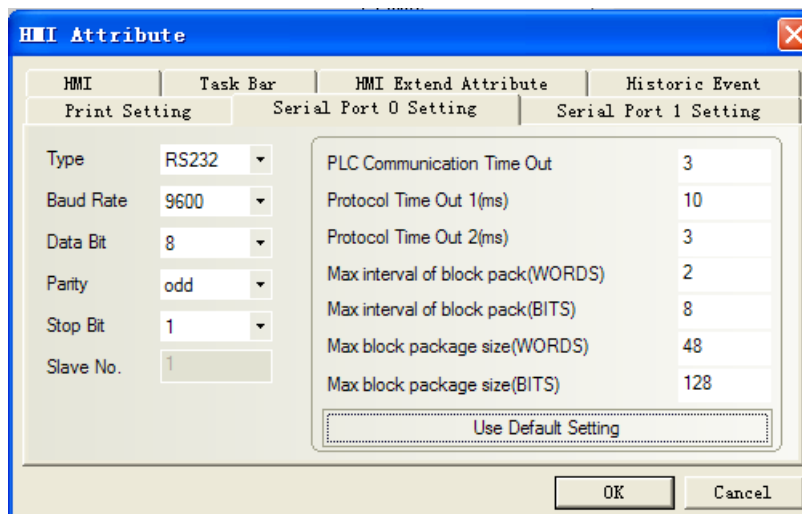

Haiwell RS485 communication

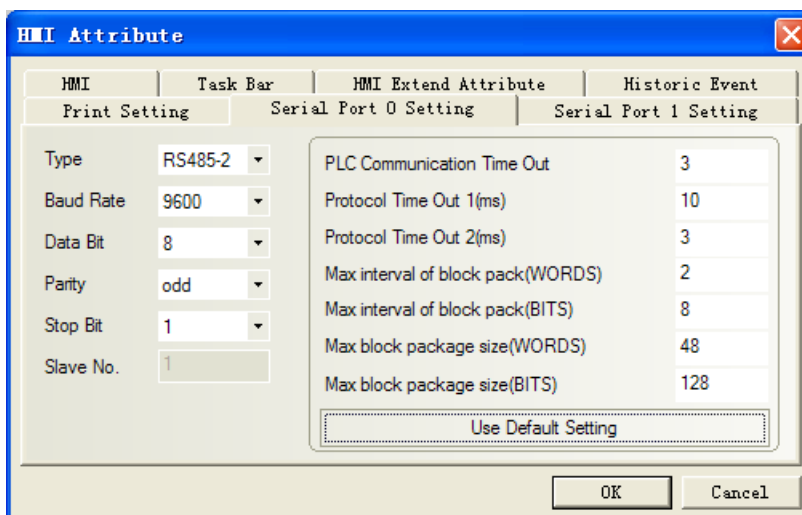

Supported Device

Device	Bit Address	Word Address	Format	Notes
Special memory Relay	SM0-215	-----	DDD	
Counter Relay	C0-127	-----	DDD	
Timer Relay	T0-127	-----	DDD	
Internal Relay	M0-2047	-----	DDDD	
Switch Output	Y0-127	-----	DDD	
Switch Input	X0-127	-----	DDD	
System register	-----	SV0-139	DDD	
Counter(Current Value)	-----	CCV-16 0-47&80-127	DDD	

Counter(Current Value double word)	-----	CCV-32 48-79	DD	
Timer(Current Value)	-----	TCV0-127	DDD	
Internal Register	-----	V0-2047	DDDD	
Analog Output	-----	AQ0-31	DD	
Analog Input	-----	AI0-31	DD	

Cable Diagram

Haiwell RS232 communication cable

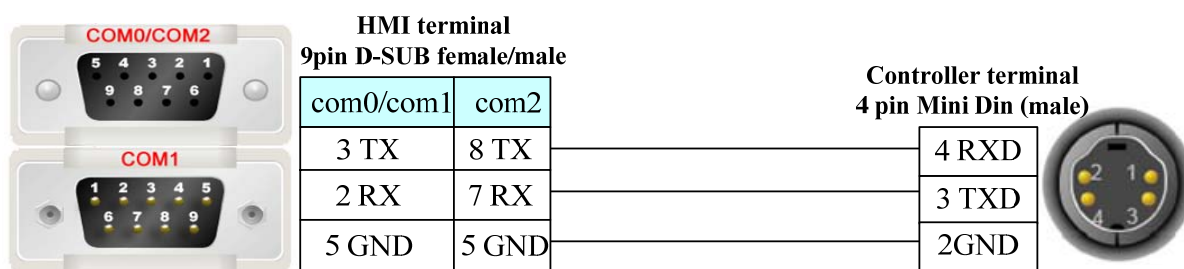

Haiwell RS485 communication cable

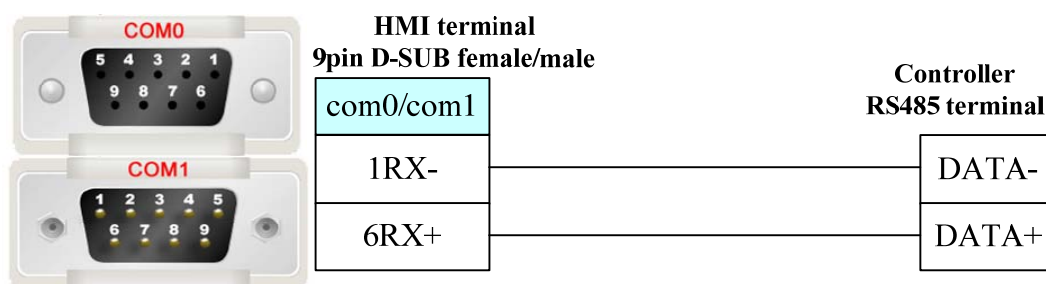

HanG

Serial Communication

Series	CPU	Link Module	Driver
HanG	DTS3338	RS485 on the CPU unit	HanG

System configuration

Series	CPU	Link Module	COMM Type	Parameter	Cable
HanG	DTS3338	RS485 on the CPU unit	RS485	Setting	Your owner cable

Communication Setting

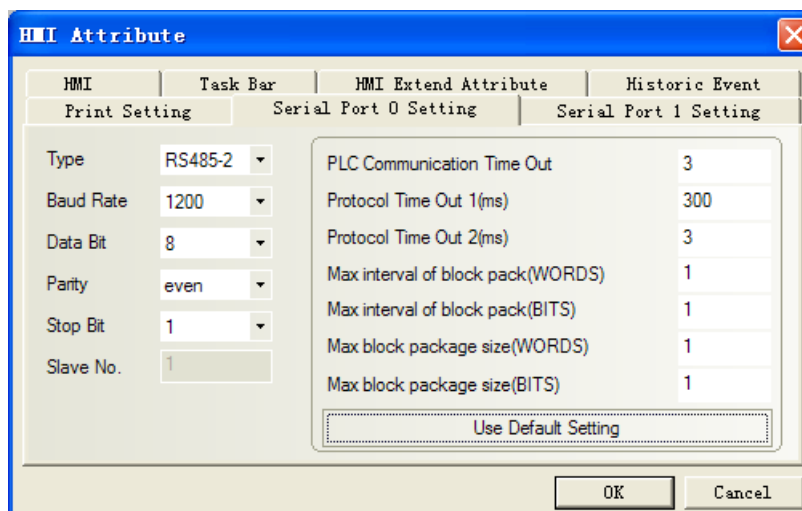

Supported Device

Device	Bit Address	Word Address	Format	Notes
Password	-----	APAS 0	H	
Meter Number	-----	ANUM C032	HHHH.H	
Init Meter	-----	ASTR 0	H	
Register value	-----	AMVD 9010	HHHH	

Note: Use text part to show meter number (ANUM). AMVD data type: signed integer

Cable Diagram

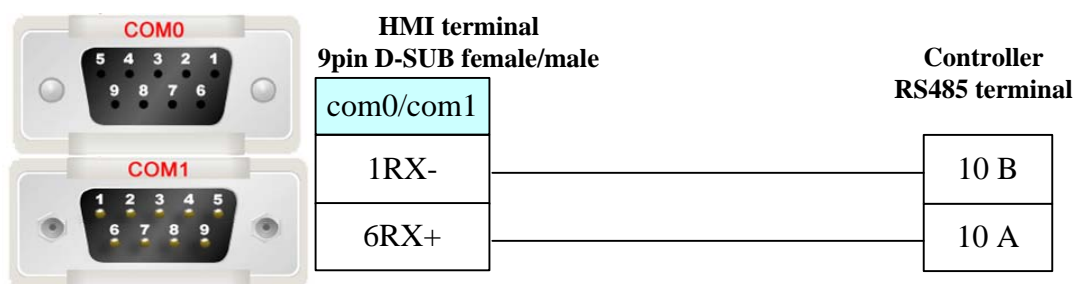

Hitachi Inverter

Serial Communication

Series	CPU	Link Module	Driver
Hitachi Inverter	SJ300	RS485-2	Hitachi SJ300

System configuration

Series	CPU	Link Module	Parameter	Cable
Hitachi Inverter	SJ300	RS485-2	Setting	Your owner cable

Communication Setting

HMI default communication parameter: 4800, 7, none, 1; station: 1

Inverter internal setting

Code	Name	description
A001	Frequency set	00(VR)/01(Terminal)/02(operator)/03(RS485)/04(OPT 1)/05(OPT 2)
A002	Run set	01(Terminal)/02(operator)/03(RS485) /04(OPT 1)/05(OPT 2)
C71	Baudrate	02(close loop detect)/ 03(2400bps)/ 04(4800bps)/ 05(9600bps)/ 06(19200bps)
C72	Station set	1~32
C73	Data bit	7(7 bit)/8(8 bit)
C74	Parity	00(none)/01(even)/02(odd)
C75	Stop bit	1(bit)/2(bit)

Note: A001, A002 must be set 03 (RS485) in order to communication with HMI.

Supported Device

Device	Bit Address	Word Address	Format	Notes
--------	-------------	--------------	--------	-------

	-----	P Extend Func 0~50	DD	
	-----	H Extend Func 0~512	DDD	
	-----	F Func Date 0~65535	DDDDD	
	-----	C Func Date 0~65535	DDDD	
	-----	B Func Date 0~999	DDD	
	-----	A Func Date 0~999	DDD	
FWD/REW/STOP		(00)FWD/REW/STOP 0	D	Write only
FREQ SET	-----	(01)FREQ SET 0	D	Write only
TerminalPoint State		(02)TerminalPoint State 0~7	D	Write only
Surveillance Data	-----	(03)Surveillance Data 0~12	DD	Read only
Transducer State		(04)Transducer State 0~3	D	Read only
Trip Record	-----	(05)Trip Record 0~54	DD	Read only
Revert	-----	(08)Revert 0	D	Write only
Recount Motor Con	-----	(0B)Recount Motor Cons 0	D	Write only
Store EEPROM	-----	Store EEPROM 0	D	

Note: (02)TerminalPoint State 0~7 use text part

Cable Diagram

RS485-2 communication cable

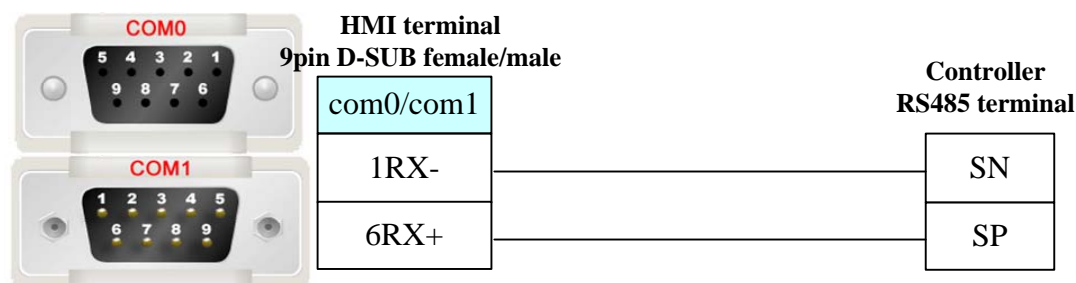

Hitachi IES Co., Ltd

Serial Communication

Series	CPU	Link Module	Driver
H	H-20 H-28 H-40	port on CPU	Hitachi

H-64

H-200(CPU-02H)

H-250(CPU21-02H)

	H-252B(CPU22-02HB) H-252C(CPU22-02HC) H-300(CPU-03Ha) H-302(CPU2-03H) H-700(CPU-07Ha) H-702(CPU2-07H) H-2000(CPU-20Ha) H-2002(CPU2-20H) H-4010(CPU3-40H) H-1002(CPU2-10H)		
	H-300(CPU-03Ha) H-302(CPU2-03H) H-700(CPU-07Ha) H-702(CPU2-07H) H-2000(CPU-20Ha) H-2002(CPU2-20H) H-4010(CPU3-40H)	COMM-H COMM-2H	
	H-1002(CPU2-10H)	COMM-2H	
EH-150	EH-150(EH-CPU104) EH-150(EH-CPU104A) EH-150(EH-CPU208) EH-150(EH-CPU208A) EH-150(EH-CPU308) EH-150(EH-CPU308A) EH-150(EH-CPU316) EH-150(EH-CPU316A) EH-150(EH-CPU448) EH-150(EH-CPU448A) EH-150(EH-CPU516) EH-150(EH-CPU548)	Serial port 1 on CPU Serial port 2 on CPU	
	EH-150(EH-CPU516) EH-150(EH-CPU548)	Port 1 on EH-SIO Port 2 on EH-SIO	
MICRO-EH	MICRO-EH(EH-D10□□□) MICRO-EH(EH-A14□□□) MICRO-EH(EH-D14□□□) MICRO-EH(EH-A23□□□) MICRO-EH(EH-D23□□□) MICRO-EH(EH-A28□□□) MICRO-EH(EH-D28□□□)	Port 1 on CPU	
	MICRO-EH(EH-A23□□□) MICRO-EH(EH-D23□□□) MICRO-EH(EH-A28□□□) MICRO-EH(EH-D28□□□)	Port 2 on CPU	
	MICRO-EH(EH-A64□□□)	Port on CPU	

	MICRO-EH(EH-D64□□□) MICRO-EH(EH-A40□□□) MICRO-EH(EH-D40□□□) MICRO-EH(EH-A20□□□) MICRO-EH(EH-D20□□□)	EH-OB232 EH-OB485	
--	---	----------------------	--

System configuration

Series	CPU	Link Module	COMM Type	Parameter	Cable
H	H-20	RS232 on the CPU unit	RS232		
EH-150	EH-150(EH-CPU104)	Serial port 1 on CPU Serial port 2 on CPU			
MICRO-EH	EH-A23DR	Port 1 on CPU	RS232	Setting_	Your owner cable
		Port 2 on CPU	RS485	Setting_	Your owner cable

Communication Setting

RS232 communication

The screenshot shows the 'HMI Attribute' dialog box with the 'Serial Port 0 Setting' tab selected. The 'Type' is set to 'RS232'. The 'Baud Rate' is 19200, 'Data Bit' is 7, 'Parity' is even, 'Stop Bit' is 1, and 'Slave No.' is 0. The 'PLC Communication Time Out' is 3. The 'Protocol Time Out 1(ms)' is 500, and 'Protocol Time Out 2(ms)' is 3. The 'Max interval of block pack(WORDS)' is 16, 'Max interval of block pack(BITS)' is 32, 'Max block package size(WORDS)' is 32, and 'Max block package size(BITS)' is 128. There is a 'Use Default Setting' button and 'OK' and 'Cancel' buttons at the bottom.

RS422 communication

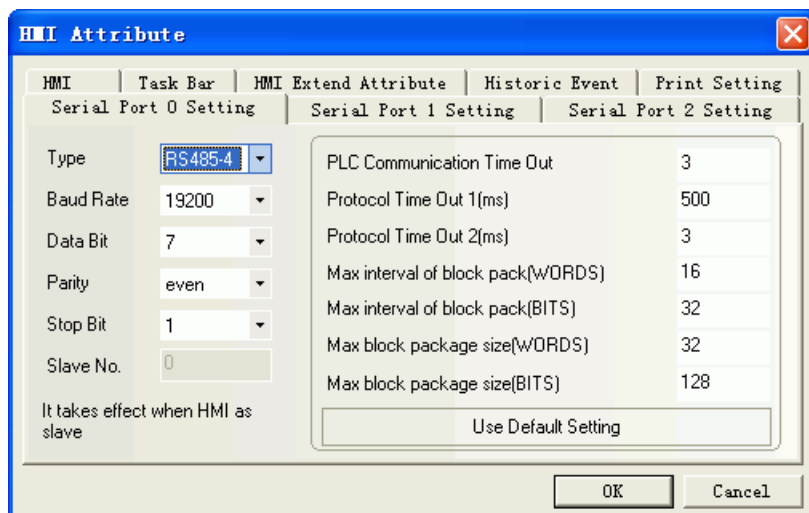

Supported Device

Hitachi EH-A23DR

Device	Bit Address	Word Address	Format	Notes
External Input	X 00.000-5A.095	-----	HHH.DDD	Read Only
External Output	Y 00.000-5A.095	-----	HHH.DDD	
Remote Input	X 100.000-9FF.095	-----	HHH.DDD	Read Only
Remote Output	Y 100.000-9FF.095	-----	HHH.DDD	
Internal Output	R 0000-FFFF	-----	HHHH	
Data Area	M 0000-FFFF	-----	HHHH	
First CPU Link	L 00000-03FFF	-----	HHHHH	
Second CPU Link	L 10000-FFFFF	-----	HHHHH	
On Delay Timer	TD 00000-65535	-----	DDDDD	
External Input	-----	WX 000.00-05A.09	HHH.DD	Read Only
External Output	-----	WY 000.00-05A.09	HHH.DD	
Remote Input	-----	WX 100.00-9FF.09	HHH.DD	Read Only
Remote Output	-----	WY 100.00-9FF.09	HHH.DD	
Word Internal Output	-----	WR 0000-C3FF	HHHH	
Special Word Output	-----	WRF 000-FFFF	HHHH	
Data Area	-----	WM 0000- FFFF	HHHH	
First CPU Link	-----	WL 0000-03FF	HHHH	
Second CPU Link	-----	WL 1000-FFFF	HHHH	
Timer Counter	-----	TC 00000-65535	DDDDD	

Note: X0.015 in the HMI match x15 in the PLC, Y1.000 in the HMI match Y100, WX0.09 in the HMI match WX9 in the Plicate effective address is deleted radix point and the first zero behind radix point.

The list of address correspondence

Bit Address	Word Address	PLC address	Notes
X 00.000-00.047		X 0000-0047	
Y 01.000-01.031		Y 0100-0131	
	WX 000.00-000.03	WX 0000-0003	
	WY 001.00-Y001.01	WY 0010-0011	

Note:

The range of X, Y, WX, WY is according to the I/O assign. Make sure the I/O address before using the register.

Note:**1. Communication setting**

EH series, only port1 supports procedure 2. Switch DIP and change special Internal Input (WR) value to select procedure.

- . EH150 series, only EHCPU***A/448/516/548 support procedure 2.
- . EH PLC connect with PC only by procedure 1.

2. CPU related actionsEH150

- . DIP 5 must be set on.
 - . If DIP 5 is on, which procedure (1 or 2) to use by judging the value of the **WR F037**. The highest bit of **WR F037** must be on, so that the other bits can be written in. The data keep on, when turn on the power again.
 - o By entering **0x8000**, turn on the power again and value of the address is 0x0000. After settings, communication with procedure 1.
 - o By entering **0xC000**, turn on the power again and value of the address is 0x4000. After settings, communication with procedure 2.
- . The transmission speed of port 1 will be set with DIP 3, 4 switches
 - o 3 on, 4 off is 19200 bps
- . The transmission speed of port 2 will be set with DIP 6, PHL switches.
 - o 6 off, PHL on is 19200 bps

MicroEH

- . The transmission speed will be set with DIP switches
 - o SW1 on is 19200 bps
- . Which procedure(1 or 2) to use by judging the value of the **WR F01A**. Different with EH150, The highest bit of **WR F01A** is optional, The data will reset when turn on the power again. If the value of **R 7F6** is set on, the data of **WR F01A** will be stored in Flash memory.
 - o **0x0000** for procedure 1.
 - o **0x8000** for procedure 2.

Note: if procedure 2 is set and written in Flash memory, external device (only supports procedure 1) or ladder editor will not connect with it.

Cable Diagram**Programming cable, as follow:**

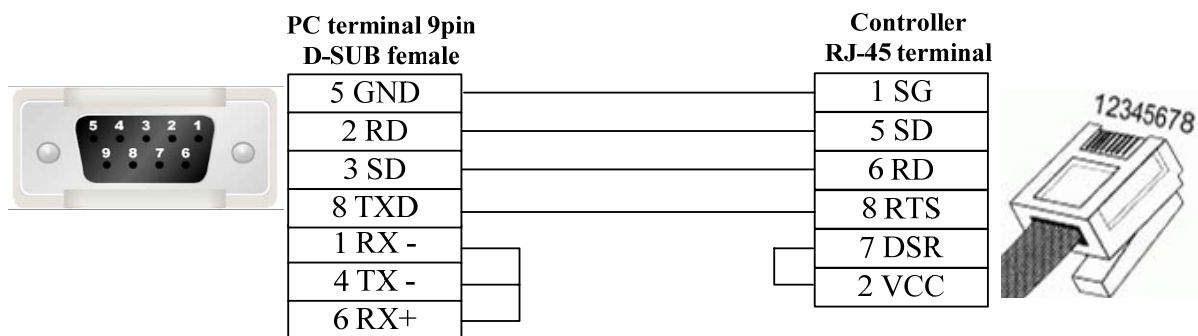

Hitachi EH-A23DR RS232 communication cable

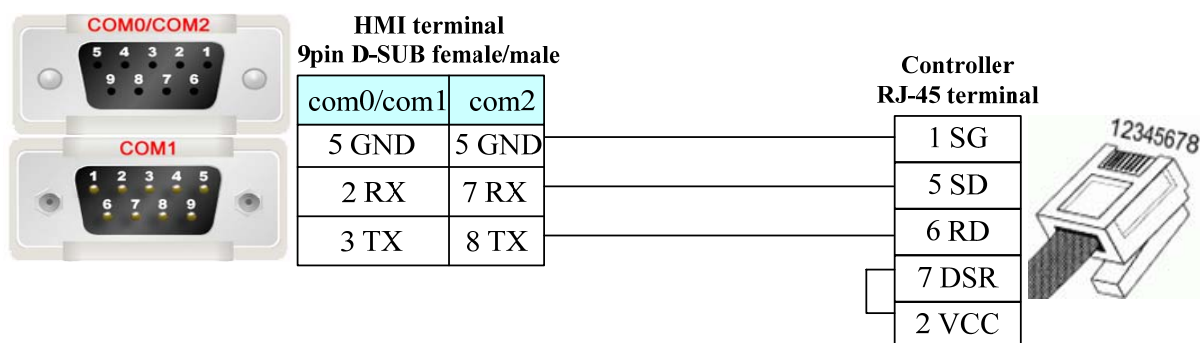

Hitachi EH-A23DR RS422 communication cable

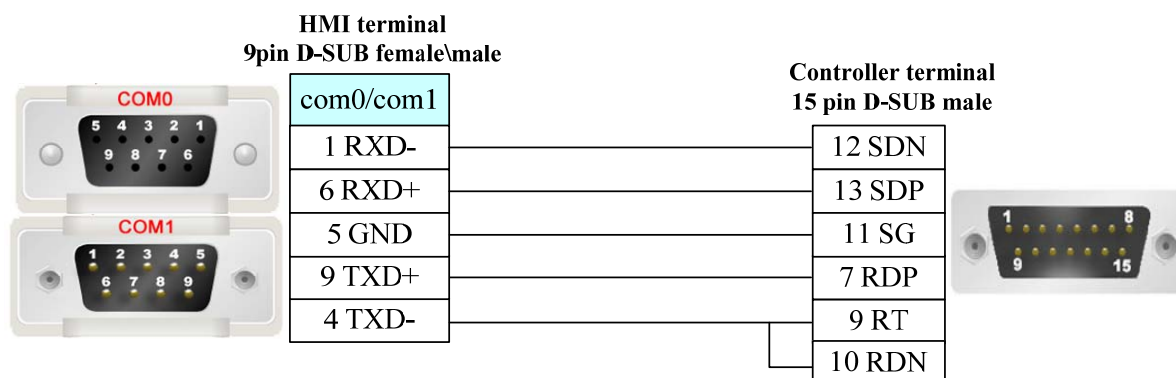

Hollysys Corporation

Serial Communication

Series	CPU	Link Module	Driver
Hollysys LM	LM3109	Serial port0 on CPU 485 Serial port1 on CPU 232	Hollysys LM
	LM3107	RS232 on CPU	

System configuration

Series	CPU	Link Module	COMM Type	Parameter	Cable
Hollysys LM	LM3109	RS232 on the CPU unit	RS232	Setting	Your owner cable
		RS485 on the CPU unit	RS485	Setting	Your owner cable
	LM3107	RS232 on the CPU unit	RS232	Setting	Your owner cable

Communication Setting

Hollysys LM RS232

The screenshot shows the 'HMI Attribute' dialog box with the 'Serial Port 0 Setting' tab selected. The 'Type' is set to 'RS232'. The 'Baud Rate' is '38400', 'Data Bit' is '8', 'Parity' is 'none', 'Stop Bit' is '1', and 'Slave No.' is '1'. The 'PLC Communication Time Out' is '3'. The 'Protocol Time Out 1(ms)' is '3', and 'Protocol Time Out 2(ms)' is '3'. The 'Max interval of block pack(WORDS)' is '2', 'Max interval of block pack(BITS)' is '8', 'Max block package size(WORDS)' is '64', and 'Max block package size(BITS)' is '128'. There is a 'Use Default Setting' button and 'OK' and 'Cancel' buttons at the bottom.

Hollysys LM RS485

The screenshot shows the 'HMI Attribute' dialog box with the 'Serial Port 0 Setting' tab selected. The 'Type' is set to 'RS485-2'. The 'Baud Rate' is '38400', 'Data Bit' is '8', 'Parity' is 'none', 'Stop Bit' is '1', and 'Slave No.' is '1'. The 'PLC Communication Time Out' is '3'. The 'Protocol Time Out 1(ms)' is '3', and 'Protocol Time Out 2(ms)' is '3'. The 'Max interval of block pack(WORDS)' is '2', 'Max interval of block pack(BITS)' is '8', 'Max block package size(WORDS)' is '64', and 'Max block package size(BITS)' is '128'. There is a 'Use Default Setting' button and 'OK' and 'Cancel' buttons at the bottom.

Supported Device

Device	Bit Address	Word Address	Format	Notes
Discrete inputs and image Relay	I0.0-2.7	-----	D.O	

Discrete outputs and image Relay	Q0.0-1.7	-----	D.O	
Internal memory Relay	M100.0-7816.7	-----	DDDD.O	
Analog inputs	-----	IW0	D	
Analog outputs	-----	QW0	D	
Internal register	-----	MW0-8190	DDDD	
Internal register(double word)	-----	MD0-8188	DDDD	

Note:

- IW,QW,MW,MD address must be an even number;
- IW,QW address range to 30 by adding a module;
- I,IW register read only;
- MB0-MB99 are occupied by system diagnosis.

Cable Diagram

Hollysys LM RS232 communication cable

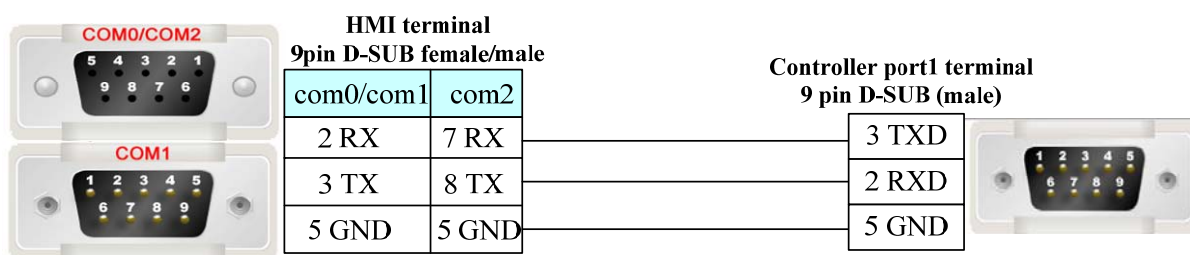

Hollysys LM RS485 communication cable

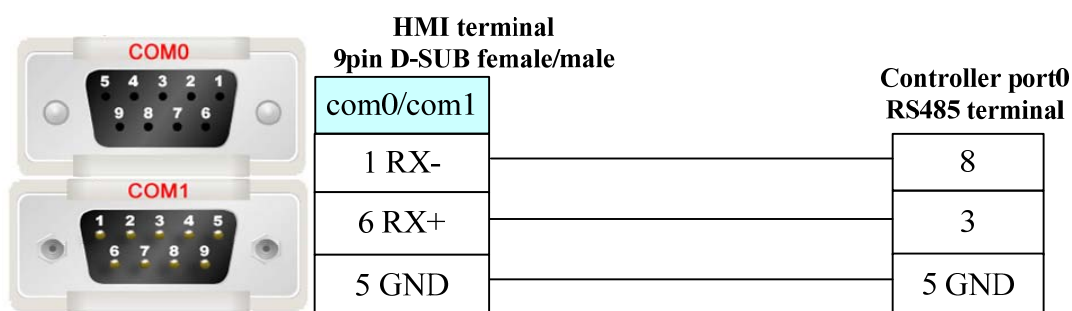

HuaDA HD-JZ06

Serial Communication

Series	CPU	Link Module	Driver
HD	HD-JZ06	RS232 on the CPU unit	HuaDA HD-JZ06\ HuaDA
		RS485 on the CPU unit	HD SLAVE

System configuration

Series	CPU	Link Module	COMM Type	Parameter	Cable
HD	HD-JZ06	RS232 on the CPU unit	RS232	Setting	Your owner cable
		RS485 on the CPU unit	RS485	Setting	Your owner cable

Communication Setting

RS232 communication

The screenshot shows the 'HMI Attribute' dialog box with the 'Serial Port 0 Setting' tab selected. The 'Type' is set to 'RS232'. The communication parameters are as follows:

Parameter	Value
Type	RS232
Baud Rate	9600
Data Bit	8
Parity	none
Stop Bit	1
Slave No.	1
PLC Communication Time Out	3
Protocol Time Out 1(ms)	50000
Protocol Time Out 2(ms)	3
Max interval of block pack(WORDS)	16
Max interval of block pack(BITS)	32
Max block package size(WORDS)	64
Max block package size(BITS)	64

Buttons: OK, Cancel, Use Default Setting

RS485 communication

The screenshot shows the 'HMI Attribute' dialog box with the 'Serial Port 0 Setting' tab selected. The 'Type' is set to 'RS485-2'. The communication parameters are as follows:

Parameter	Value
Type	RS485-2
Baud Rate	9600
Data Bit	8
Parity	none
Stop Bit	1
Slave No.	1
PLC Communication Time Out	3
Protocol Time Out 1(ms)	50000
Protocol Time Out 2(ms)	3
Max interval of block pack(WORDS)	16
Max interval of block pack(BITS)	32
Max block package size(WORDS)	64
Max block package size(BITS)	64

Buttons: OK, Cancel, Use Default Setting

Supported Device

Device	Bit Address	Word Address	Format	Notes
HMI Internal Relay	LB 0-4095	-----	DDDD	
HMI Internal register	-----	LW 0-4094	DDDD	
MCU Register	-----	VB 0-4095	DDDD	

MCU Register	-----	VW 0-4094	DDDD	
--------------	-------	-----------	------	--

Cable Diagram

RS232 Port

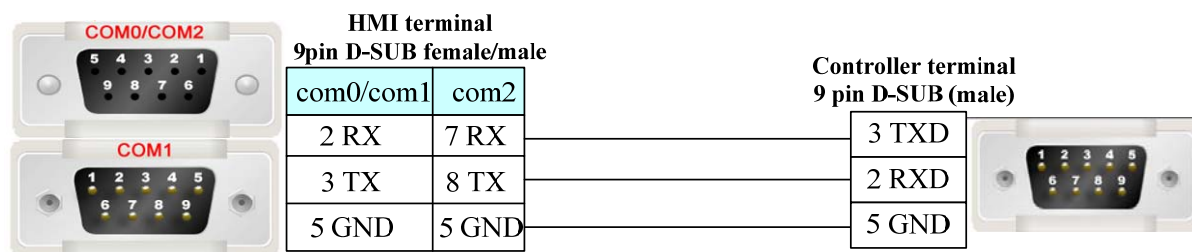

RS485 Port

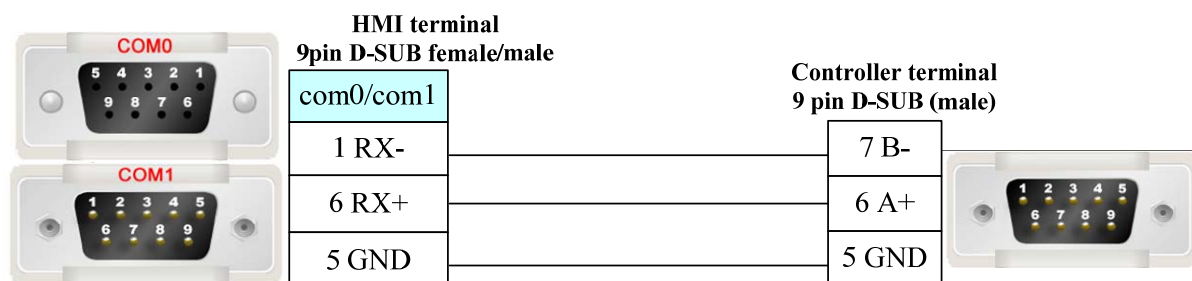

IDEC Corporation

Serial Communication

Series	CPU	Link Module	Driver
MICRO SMART	FC4A-C10R2	RS232 on the CPU unit	IDEC MicroSmart

System configuration

Series	CPU	Link Module	COMM Type	Parameter	Cable
MICRO SMART	FC4A-C10R2	RS232 on the CPU unit	RS232	Setting	Your owner cable

Supported Device

Device	Bit Address	Word Address	Format	Notes
Internal Relay	M0.0-127.7	-----	DDD.O	
Output	Q0.0-30.7	-----	DD.O	
Input	I0.0-30.7	-----	DD.O	
Data Register	-----	D0-8199	DDDD	

Counter(Current Value)	-----	C_CV0-99	DD	
Counter(Preset Value)	-----	C_SV0-99	DD	
Timer(Current Value)	-----	T_CV0-99	DD	
Timer(Preset Value)		T_SV0-99	DD	

Note: M address: 121 in the plc correspond to 12.1 in the EV5000.

QI address: 1277 in the plc corresponds to 127.7 in the EV5000.

Communication Setting

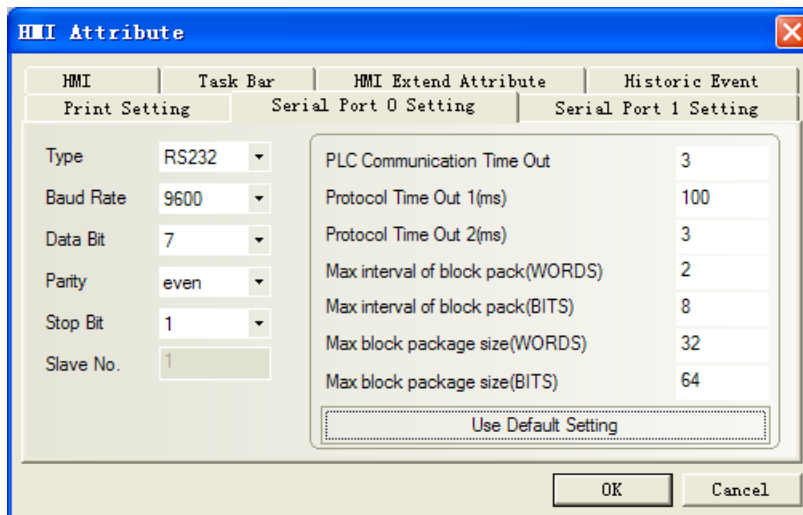

Cable Diagram

Idec RS232 communication cable

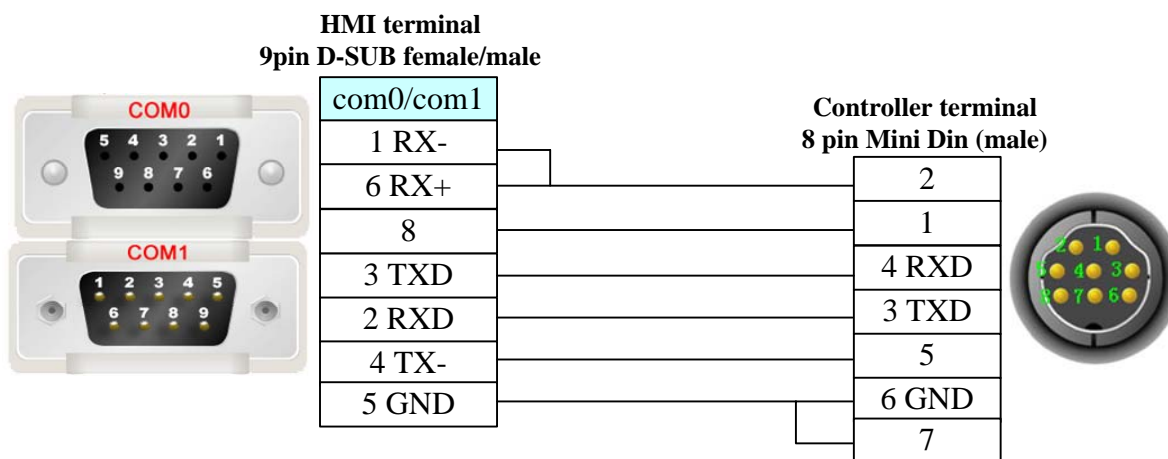

KDN Corporation

Serial Communication

Series	CPU	Link Module	Driver
KDN-K3	KDN-K304-14AR	RS232 on the CPU unit	KDN-K3

System configuration

Series	CPU	Link Module	COMM Type	Parameter	Cable
KDN-K3	K304-14AR	RS232 on the CPU unit	RS232	Setting	Your owner cable

Supported Device

KDN-K3

Device	Bit Address	Word Address	Format	Notes
Discrete inputs and image Relay	I0.0-7.7	-----	D.O	
Discrete outputs and image Relay	Q0.0-7.7	-----	D.O	
Internal memory Relay	M0.0-31.7	-----	DD.O	
Analog inputs	-----	AIW0-30	DD	
Analog outputs	-----	AQW0-30	DD	
Internal register	-----	VW0-4094	DDDD	
Internal register(double word)	-----	VD0-4092	DDDD	

Note:

- 1) AIW, AQW, VW, VD address must be an even number.
- 2) AIW and I device read only.
- 3) The single floating VR of PLC corresponds with the VD of the Ev5000 (choose single floating).

Communication Setting

KDN-K3 RS232 communication

The screenshot shows the 'HMI Attribute' dialog box with the following settings:

Parameter	Value
Type	RS232
Baud Rate	9600
Data Bit	8
Parity	none
Stop Bit	1
Slave No.	1

Parameter	Value
PLC Communication Time Out	3
Protocol Time Out 1(ms)	3
Protocol Time Out 2(ms)	3
Max interval of block pack(WORDS)	16
Max interval of block pack(BITS)	32
Max block package size(WORDS)	32
Max block package size(BITS)	64

Buttons: OK, Cancel, Use Default Setting

Cable Diagram

RS232 communication cable

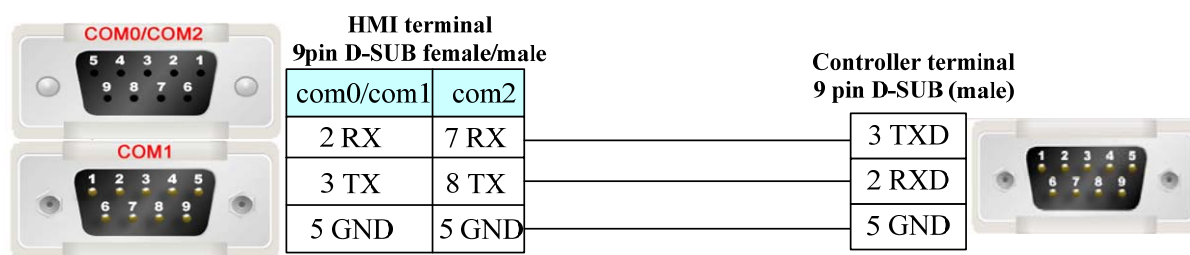

RS485 communication cable

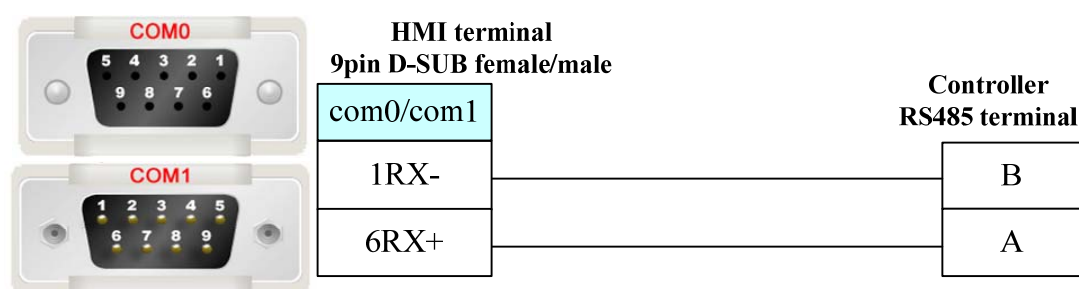

Kinco Corporation

Serial Communication

Series	CPU	Link Module	Driver
KINCO	Kinco-K306-24AR	RS232 on the CPU unit	KINCO

System configuration

Series	CPU	Link Module	COMM Type	Parameter	Cable
KINCO	K306-24AR	RS232 on the CPU unit	RS232	Setting	Your owner cable
		RS485 on the port	RS485	Setting	Your owner cable

Supported Device

KINCO

Device	Bit Address	Word Address	Format	Notes
Discrete inputs and image Relay	I0.0-31.7	-----	D.O	
Discrete outputs and image Relay	Q0.0-31.7	-----	D.O	
Internal memory Relay	M0.0-31.7	-----	DD.O	
Analog inputs	-----	AIW0-62	DD	

Analog outputs	-----	AQW0-62	DD	
Internal register	-----	VW0-4094	DDDD	
Internal register(double word)	-----	VD0-4092	DDDD	

Note:

- 1) AIW, AQW, VW, VD address must be an even number.
- 2) AIW and I device read only.
- 3) The single floating VR of PLC corresponds with the VD of the Ev5000 (choose single floating).

Communication Setting

KINCO RS232 communication

The screenshot shows the 'HMI Attribute' dialog box with the 'Serial Port 0 Setting' tab selected. The 'Type' is set to 'RS232'. The 'Baud Rate' is 9600, 'Data Bit' is 8, 'Parity' is none, 'Stop Bit' is 1, and 'Slave No.' is 1. The 'PLC Communication Time Out' is 3. The 'Protocol Time Out 1(ms)' is 3, and 'Protocol Time Out 2(ms)' is 3. The 'Max interval of block pack(WORDS)' is 16, 'Max interval of block pack(BITS)' is 32, 'Max block package size(WORDS)' is 32, and 'Max block package size(BITS)' is 64. There is a 'Use Default Setting' button at the bottom of the settings area. The 'OK' and 'Cancel' buttons are at the bottom right.

KINCO RS485 communication

The screenshot shows the 'HMI Attribute' dialog box with the 'Serial Port 0 Setting' tab selected. The 'Type' is set to 'RS485-2'. The 'Baud Rate' is 9600, 'Data Bit' is 8, 'Parity' is none, 'Stop Bit' is 1, and 'Slave No.' is 1. The 'PLC Communication Time Out' is 3. The 'Protocol Time Out 1(ms)' is 3, and 'Protocol Time Out 2(ms)' is 3. The 'Max interval of block pack(WORDS)' is 16, 'Max interval of block pack(BITS)' is 32, 'Max block package size(WORDS)' is 32, and 'Max block package size(BITS)' is 64. There is a 'Use Default Setting' button at the bottom of the settings area. The 'OK' and 'Cancel' buttons are at the bottom right.

Cable Diagram

RS232 communication cable

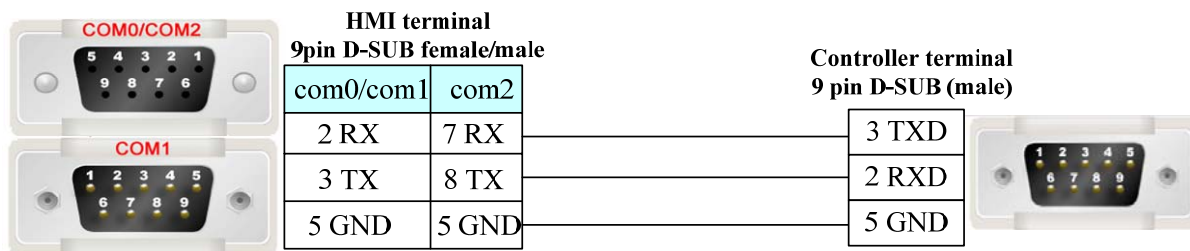

RS485 communication cable

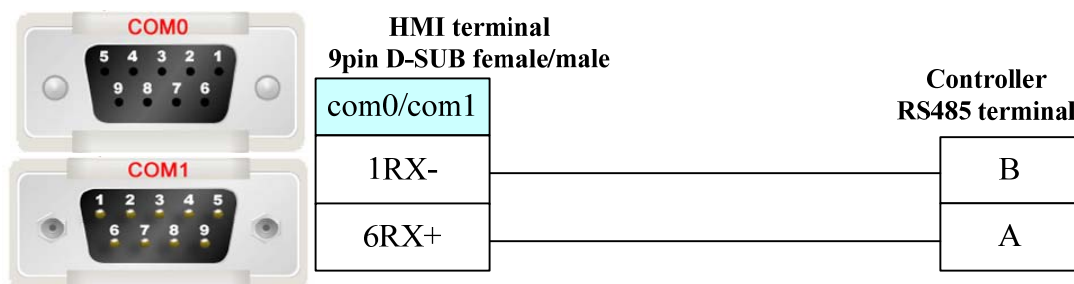

Kinco ED Series

Serial Communication

Series	CPU	Link Module	Driver
ED	ED100	RS232 on the CPU unit	Kinco ED Series
		RS485 on port	
	ED200	RS232 on the CPU unit	
		RS485 on port	
ECOVARIO	ECOVARIO	RS232 on the CPU unit	
		RS485 on port	

System configuration

Series	CPU	Link Module	COMM Type	Parameter	Cable
ED	ED100	RS232 on the CPU unit	RS232	Setting	Your owner cable
		RS485 on port	RS485-2	Setting	Your owner cable
	ED200	RS232 on the CPU unit	RS232	Setting	Your owner cable
		RS485 on port	RS485-2	Setting	Your owner cable
ECOVARIO	ECOVARIO	RS232 on the CPU unit	RS232	Setting	Your owner cable
		RS485 on port	RS485-2	Setting	Your owner cable

Communication Setting

Ecostep RS232 communication

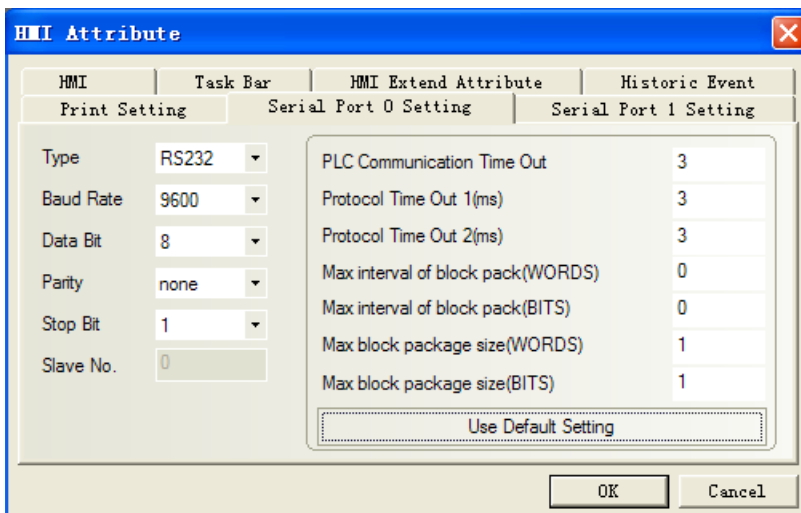

Note: If the servo controller station has been modified, the station will take effect until the servo has been restarted, otherwise communication fails.

Ecotstep RS485 communication

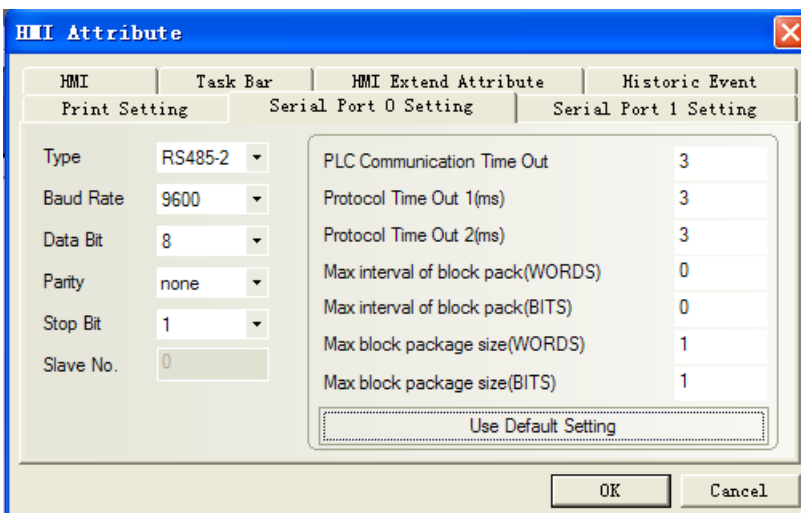

Supported Device

Device	Bit Address	Word Address	Range	Notes
word	_____	20	Refer to the kinco manual	
word	_____	10	Refer to the kinco manual	
word	_____	8	Refer to the kinco manual	

Note:

This is the address of the controller. When using the touch screen, pay attention to the rules of addressing. For details, refer to the description below:

Address type of the touch screen: Depends on the number of bits of the servo and the value can only be 20, 10 or 8.

Address of the touch screen: master address, and sub address

For example, on page 117 in the user manual for Kinco servo driver, the address is 2509,

sub-address is 06, and the number of bits is 20. The addressing diagram of the touch screen is shown as follows:

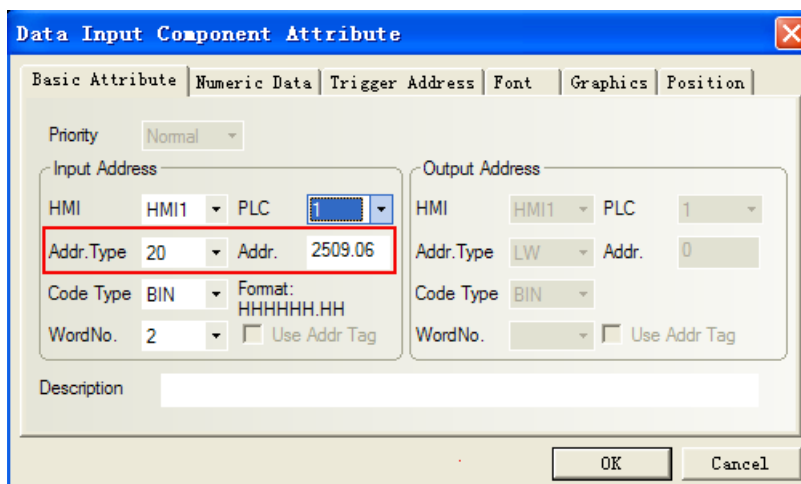

Cable Diagram

ECOSTEP RS232 communication cable

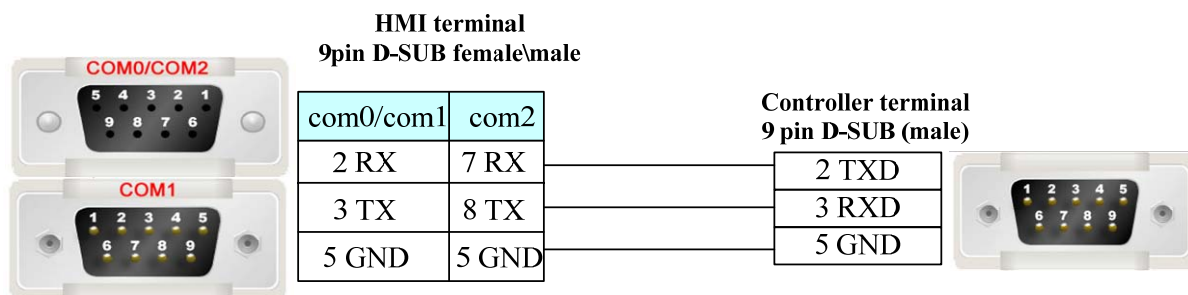

ECOSTEP RS485 communication cable

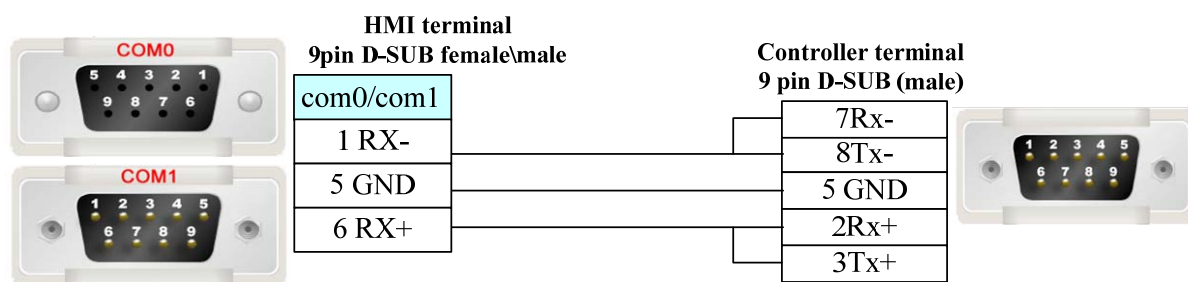

Keyence Corporation

Serial Communication

Series	CPU	Link Module	Driver
KV-16DT	KV-16DT	CPU Direct	Keyence KV-16DT

KV-1000	KV-1000	CPU Direct	Keyence KV-1000
---------	---------	------------	-----------------

System configuration

Series	CPU	Link Module	COMM Type	Parameter	Cable
KV-16DT	KV-16DT	CPU Direct	RS232	Setting	Your owner cable
KV-1000	KV-1000	CPU Direct	RS232	Setting	Your owner cable

Supported Device

KV-16DT

Device	Bit Address	Word Address	Format
Counter Relay	Counter_contact0- 59915	-----	DDDDD
Timer Relay	Timer_contact0- 65535	-----	DDDDD
High speed counter	CTH_contact0- 511	-----	DDD
High speed counter Comparator	CTC_contact0- 511	-----	DDD
Relay	Relay0- 32766	-----	DDDDD
Counter current	-----	Counter_current0- 3915	DDDD
Counter preset	-----	Counter_preset0- 65535	DDDDD
Timer current	-----	Timer_current0- 65534	DDDDD
Timer preset	-----	Timer_preset0- 11998	DDDDD
High speed counter	-----	CTH_current0- 65534	DDDDD
High speed counter	-----	CTH_preset0- 32766	DDDDD
High speed counter Comparator	-----	CTC_current0-65534	DDDDD
High speed counter Comparator	-----	CTC_preset0- 32766	DDDDD
Data memory	-----	DM0- 32766	DDDDD
Temporary data memory	-----	TM0- 32766	DDDDD

Note: Non-supported batch transfer of bits or words for this protocol.

KV-1000

Device	Bit Address	Word Address	Format	Notes
Relay	R0-59915	-----	DDDDD	
Control Relay	CR0-3915	-----	DDDD	
Internal auxiliary relay	MR0-65535	-----	DDDDD	
Latch Relay	LR0-65535	-----	DDDDD	
Data Memory	-----	DM0-65534	DDDDD	
Control Memory	-----	CM0-11998	DDDDD	
Temporary data memory	-----	TM0-511	DDD	

Extended Data memory	-----	EM0-65534	DDDDD	
Extended Data memory	-----	FM0-32766	DDDDD	

Communication Setting

KV-16DT

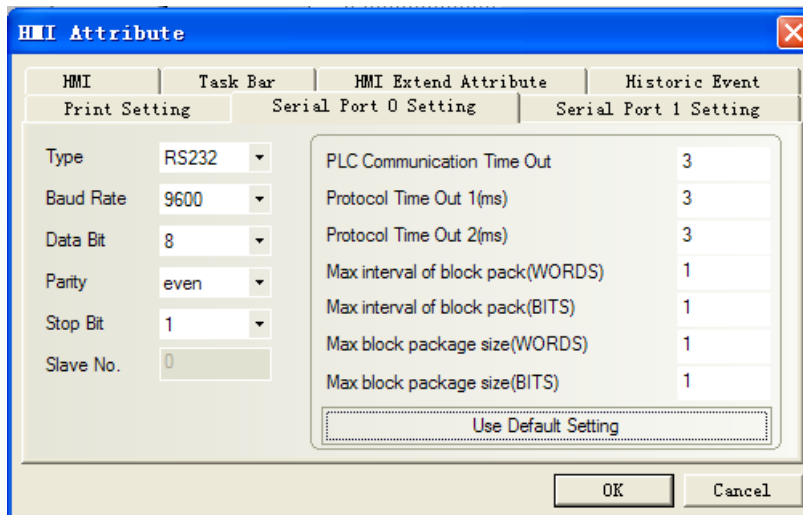

KV-1000

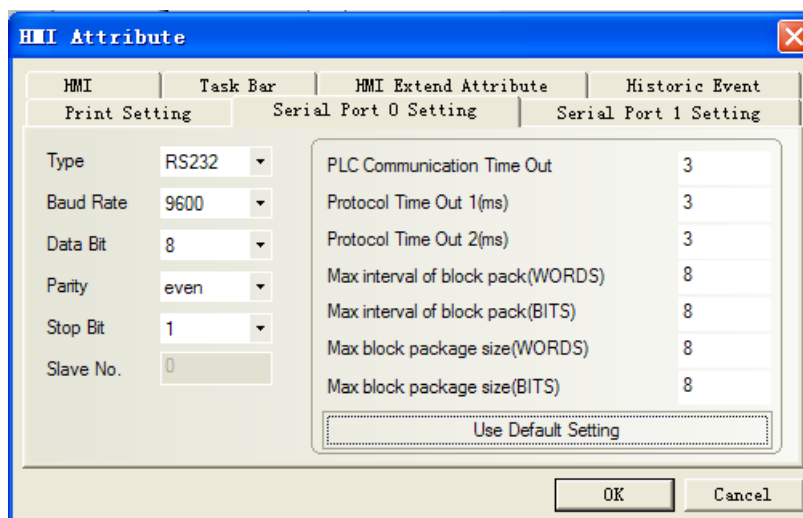

Cable Diagram

KV-16DT RS232 communication cable

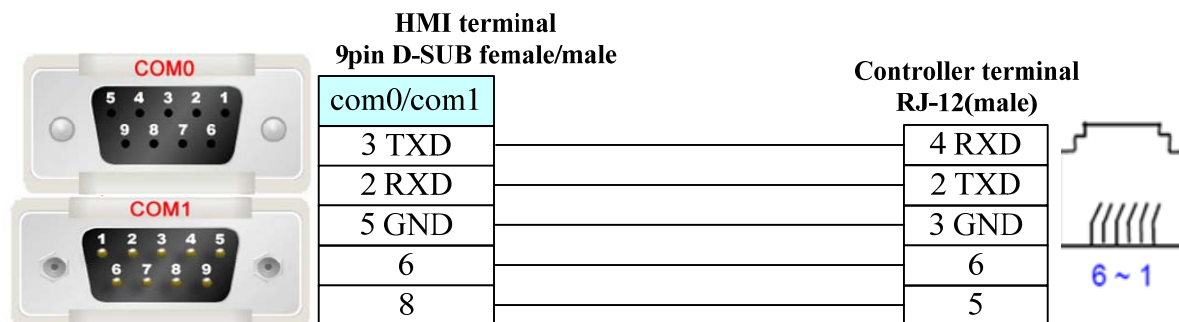

Koyo Corporation

Serial Communication

Series	CPU	Link Module	Driver
KOYO DIRECT	SM24-T	RS232 on the CPU unit	Koyo Direct
	DL06	RS232 on the port1	
	DL105		
	DL230	RS232\RS422 on the port2	
	DL240		
	DL250		
	DL350		
	DL450		

System configuration

Series	CPU	Link Module	COMM Type	Parameter	Cable
KOYO DIRECT	SM24-T	RS232 on the CPU unit	RS232	Setting	Your owner cable
			RS485-2	Setting	Your owner cable
	DL05	RS232 on the port1	RS232	Setting	Your owner cable
			DL06	RS232	Setting
	DL105	RS232 on the port2	RS485-4	Setting	Your owner cable
	DL230				
	DL240				
	DL250				
DL350					
DL450					

Supported Device

Device	Bit Address	Word Address	Format	Notes
Input	I(X)0-477	-----	OOO	
Output	Q(Y)0-477	-----	OOO	

variable	M(C)0-377	-----	000	
Timer Status	T(T)0-177	-----	000	
Counter Status	C(CT)0-177	-----	000	
Data Register	-----	R(V)0-7777	0000	

PLC software setting

1. The security password function must be disabled.
2. The COM port must adopt K sequence protocol.
3. Set the switch of the CPU with working mode setting switch to the TERM state.

Communication Setting

KOYO series RS232 communication setting

The screenshot shows the 'HMI Attribute' dialog box with the 'Serial Port 0 Setting' tab selected. The 'Type' is set to 'RS232'. The 'Baud Rate' is '9600', 'Data Bit' is '8', 'Parity' is 'odd', 'Stop Bit' is '1', and 'Slave No.' is '0'. The communication parameters are: PLC Communication Time Out (3), Protocol Time Out 1(ms) (3), Protocol Time Out 2(ms) (3), Max interval of block pack(WORDS) (2), Max interval of block pack(BITS) (64), Max block package size(WORDS) (16), and Max block package size(BITS) (128). There is a 'Use Default Setting' button and 'OK'/'Cancel' buttons at the bottom.

KOYO series RS485 communication setting

The screenshot shows the 'HMI Attribute' dialog box with the 'Serial Port 0 Setting' tab selected. The 'Type' is set to 'RS485-2'. The 'Baud Rate' is '9600', 'Data Bit' is '8', 'Parity' is 'odd', 'Stop Bit' is '1', and 'Slave No.' is '0'. The communication parameters are: PLC Communication Time Out (3), Protocol Time Out 1(ms) (3), Protocol Time Out 2(ms) (3), Max interval of block pack(WORDS) (2), Max interval of block pack(BITS) (64), Max block package size(WORDS) (16), and Max block package size(BITS) (128). There is a 'Use Default Setting' button and 'OK'/'Cancel' buttons at the bottom.

KOYO DL06 series RS422 communication setting

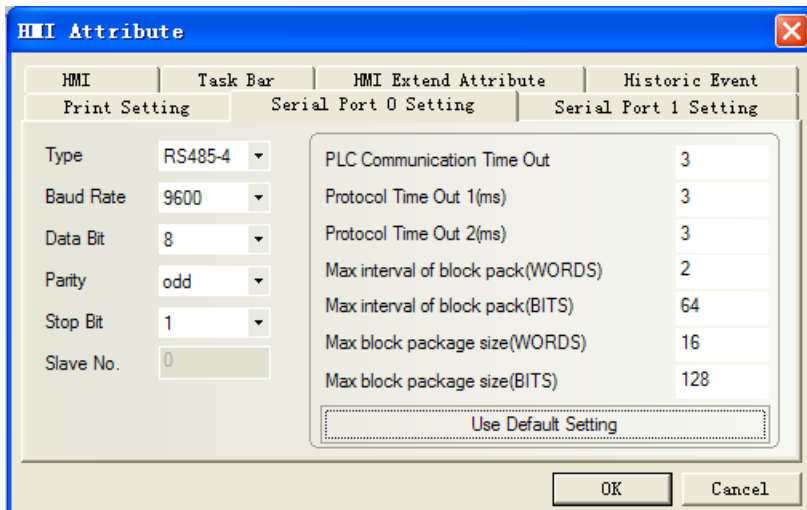

Cable Diagram

KOYO SM24-T series RS232 communication cable

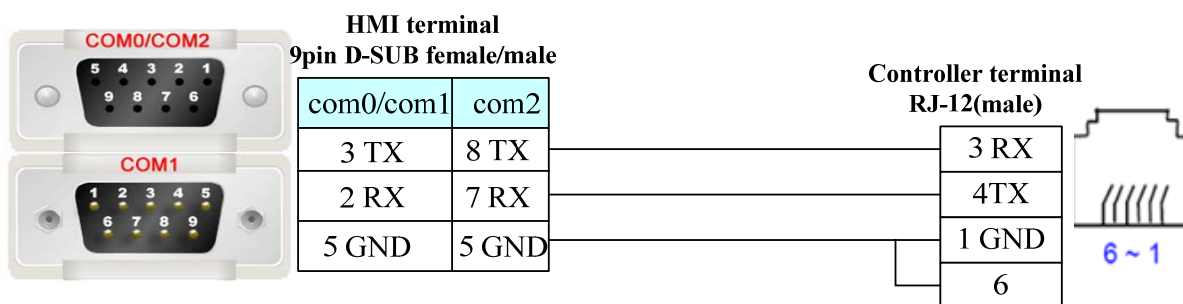

KOYO SM24-T series RS485 communication cable

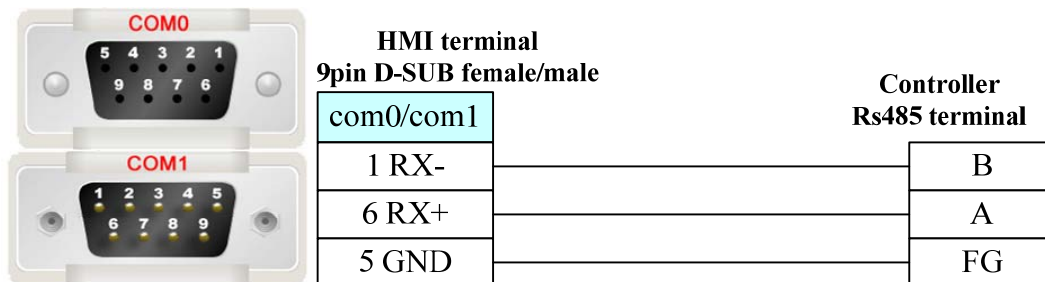

KOYO DL06 series RS232 communication cable

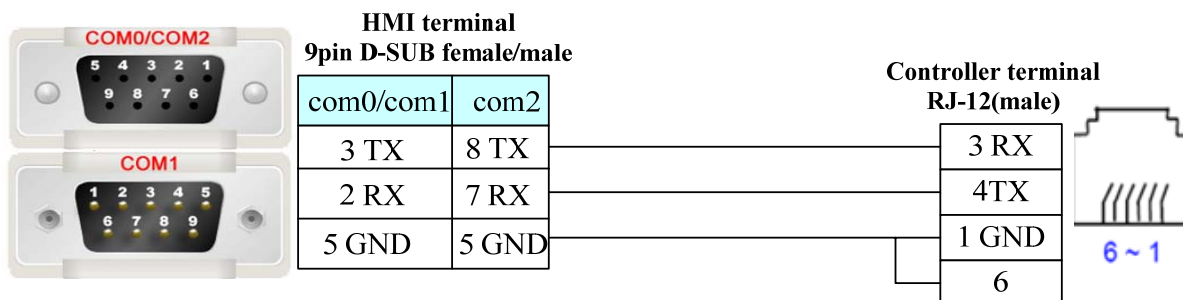

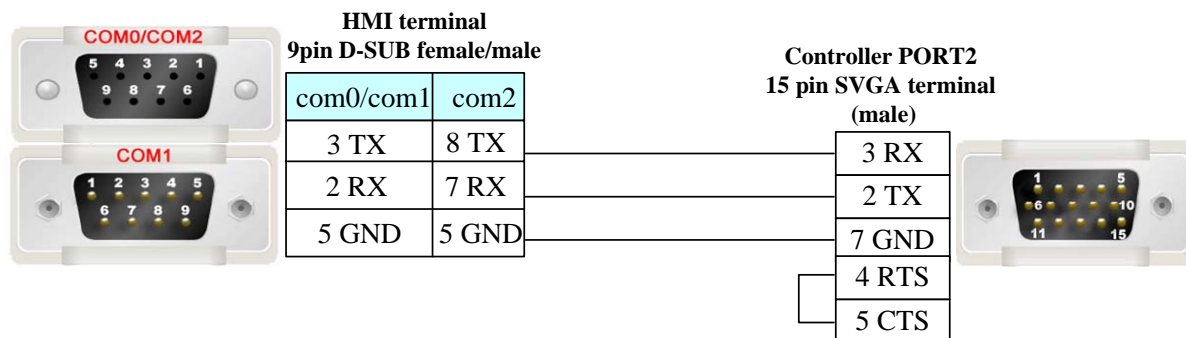

KOYO DL06 series RS422 communication cable

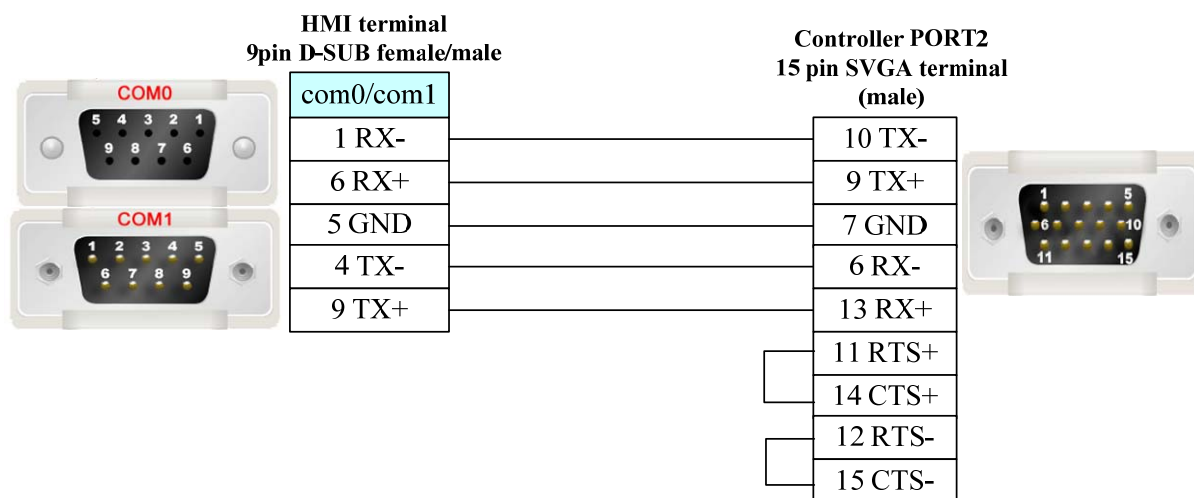

KTC Srdlink

Serial Communication

Series	CPU	Link Module	Driver
SRD	SRD2211	RS232 on CPU unit	KTC SRDLINK
		RS485 on CPU unit	
COM	COM2023	RS232 on CPU unit	
		RS485 on CPU unit	

System configuration

Series	CPU	Link Module	COMM Type	Parameter	Cable
SRD	SRD2211	RS232 on CPU unit	RS232	Setting	Your owner cable
		RS485 on CPU unit	RS485-2	Setting	Your owner cable
COM	COM2023	RS232 on CPU unit	RS232	Setting	Your owner cable
		RS485 on CPU unit	RS485-2	Setting	Your owner cable

Supported Device

Please refer to the PLC manual for details.

Communication Setting

Ktc RS232 communication

The screenshot shows the 'HMI Attribute' dialog box with the 'Serial Port 0 Setting' tab selected. The 'Type' is set to 'RS232'. The communication parameters are as follows:

Parameter	Value
Type	RS232
Baud Rate	9600
Data Bit	8
Parity	none
Stop Bit	1
Slave No.	0
PLC Communication Time Out	1
Protocol Time Out 1(ms)	1
Protocol Time Out 2(ms)	0
Max interval of block pack(WORDS)	20
Max interval of block pack(BITS)	7
Max block package size(WORDS)	20
Max block package size(BITS)	7

Buttons: OK, Cancel

Ktc RS485-2 communication

The screenshot shows the 'HMI Attribute' dialog box with the 'Serial Port 0 Setting' tab selected. The 'Type' is set to 'RS485-2'. The communication parameters are as follows:

Parameter	Value
Type	RS485-2
Baud Rate	115200
Data Bit	8
Parity	none
Stop Bit	1
Slave No.	0
PLC Communication Time Out	1
Protocol Time Out 1(ms)	1
Protocol Time Out 2(ms)	0
Max interval of block pack(WORDS)	20
Max interval of block pack(BITS)	7
Max block package size(WORDS)	20
Max block package size(BITS)	7

Buttons: OK, Cancel

Note: Must modify communication parameter in the programming software.

Cable Diagram

Ktc RS232 communication cable

Direct connect (cable by KTC Corporation)

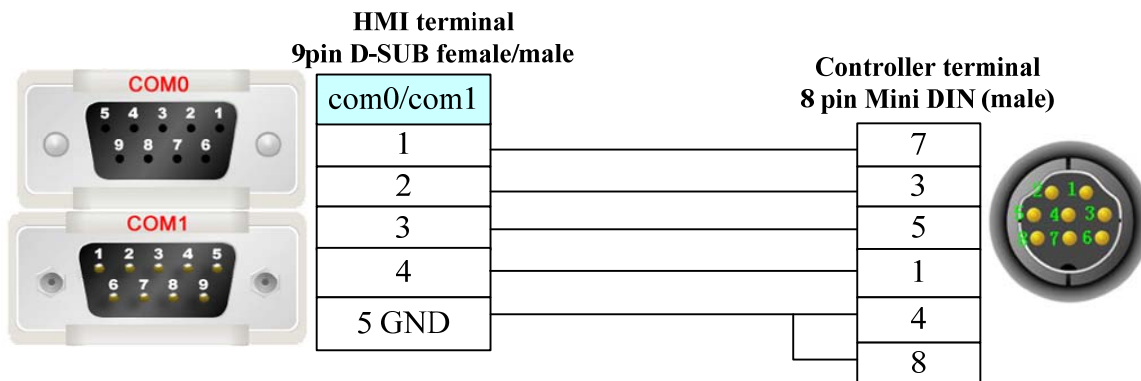

Ktc RS485 communication cable

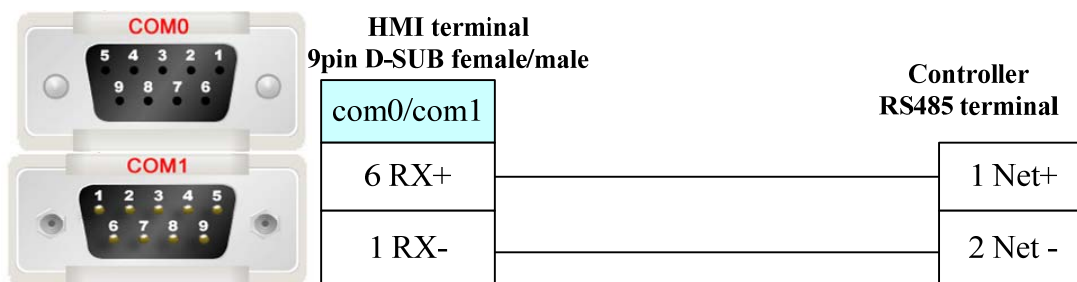

LENZE Inverter

Serial Communication

Series	CPU	Link Module	Driver
Lecom A/B	EVF9323-EV	RS232 on the CPU unit	Lecom_AB

System configuration

Series	CPU	Link Module	COM Type	Parameter	Cable
Lecom A/B	EVF9323-EV	RS232 on the CPU unit	RS232	Setting	Your owner cable
		RS485 on the CPU unit	RS485	Setting	Your owner cable

Supported Device

Refer to the PLC software for details; Global drive control

- Note:** code_H: Data type is HEX
 code_F: Data type is Floating
 code_D: Data type is Decimal

Communication Setting

Lecom AB RS232 communication

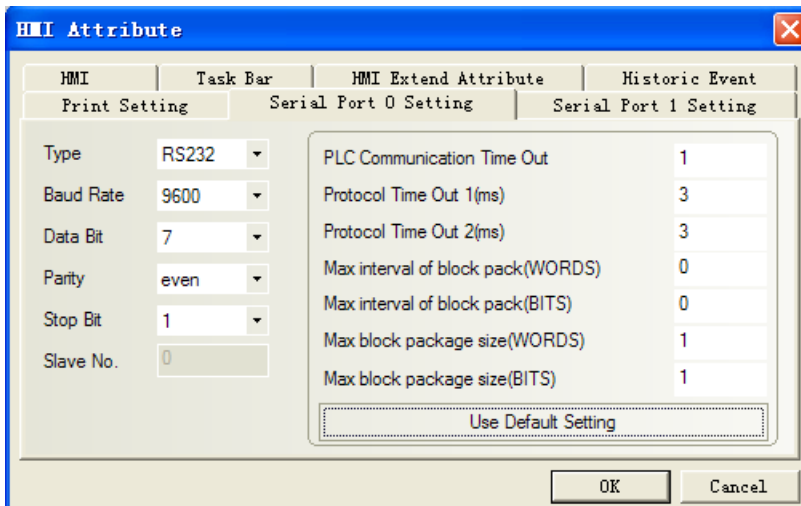

Lecom AB RS485 communication

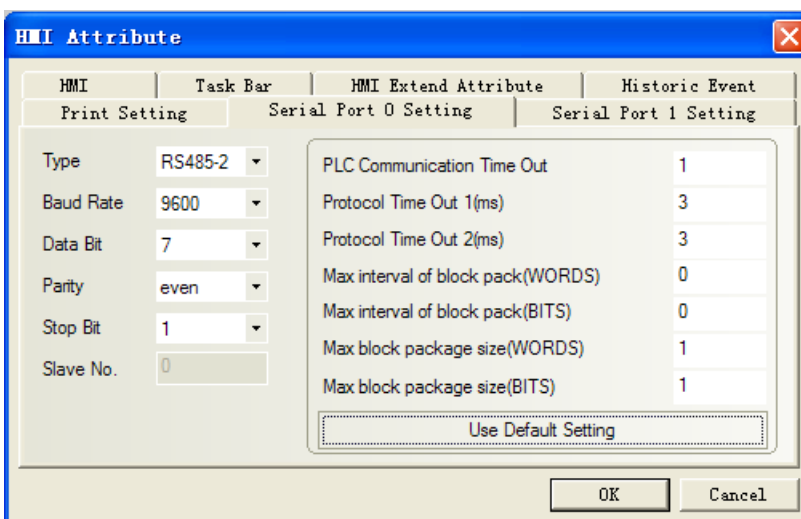

Cable Diagram

Lecom AB RS232 communication cable

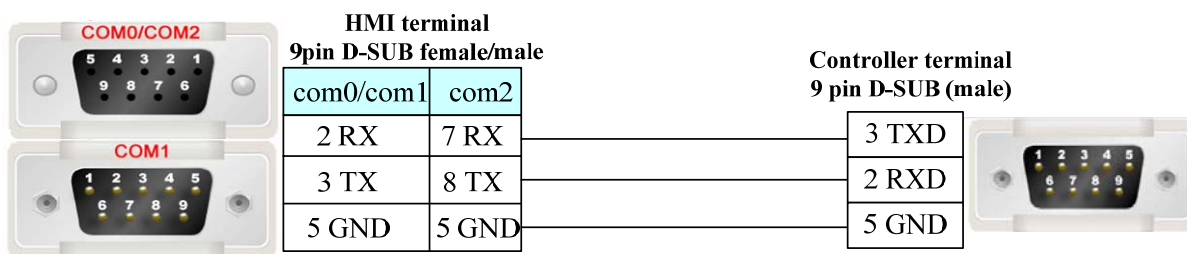

Lecom AB RS485 communication cable

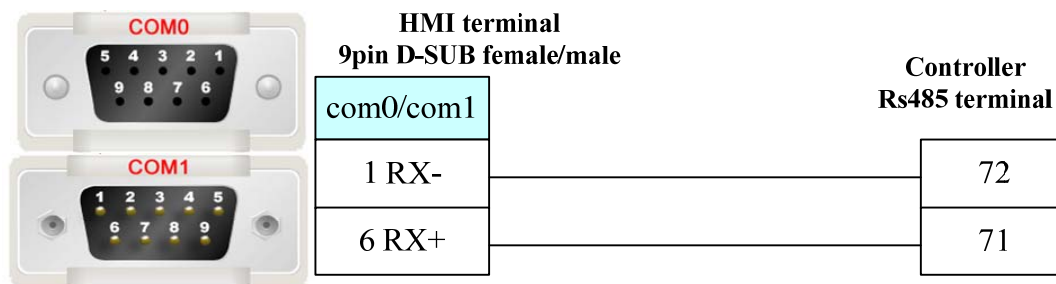

LS Industrial Systems Co., Ltd.

Serial Communication

Series	CPU	Link Module	Driver
K120S	K7M-DR10UE K7M-DR20U K7M-DT30U K7M-DT40U K7M-DT60U	Port1 on CPU unit Port2 on CPU unit	LG Master KxxxS LG Master K-Cnet LG Modbus RTU
XGB	XBC-DN64H XBC-DR32H	RS232 on the CPU unit	LG XGT CPU Serial
		RS232 on the channel1	LG XGT_Cnet Series
		RS485 on the channel2	

Note:

1. Switch the DIP2 to be ON, DIP1 to be OFF, when you use the LG Master K-cnet and LG Modbus Rtu drivers (It is not necessary to switch the dip for the LG Master KxxxS driver),
2. Non-support RS485 communication mode for the LG Master KxxxS driver;
3. Only Cnet protocol supports PLC station No.

System configuration

Series	CPU	Link Module	COMM Type	Parameter	Cable
K120S	K7M-DR10UE	Port1 on CPU unit	RS232	Setting	Your owner cable
		Port2 on CPU unit	RS485-2	Setting	Your owner cable
	K7M-DR20U	Port1 on CPU unit	RS232	Setting	Your owner cable
		Port2 on CPU unit	RS485-2	Setting	Your owner cable
XG	XBC-DN64H XBC-DR32H	RS232 on the CPU unit	RS232	Setting	Your owner cable
		RS232 on the channel1	RS232	Setting	Your owner cable
		RS485 on the channel2	RS485	Setting	Your owner cable

Communication Setting

LG Master K-cnet protocol default communication: 38400, 8, none, 1; station number: 1

RS232 communication

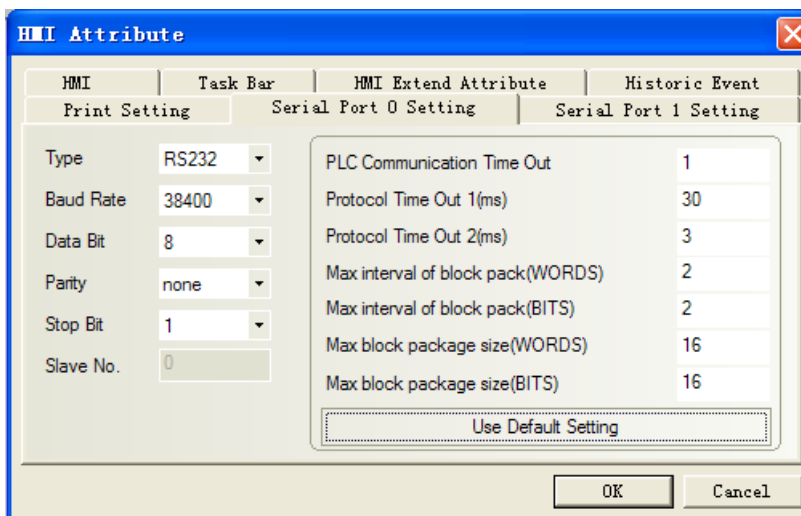

RS485 communication

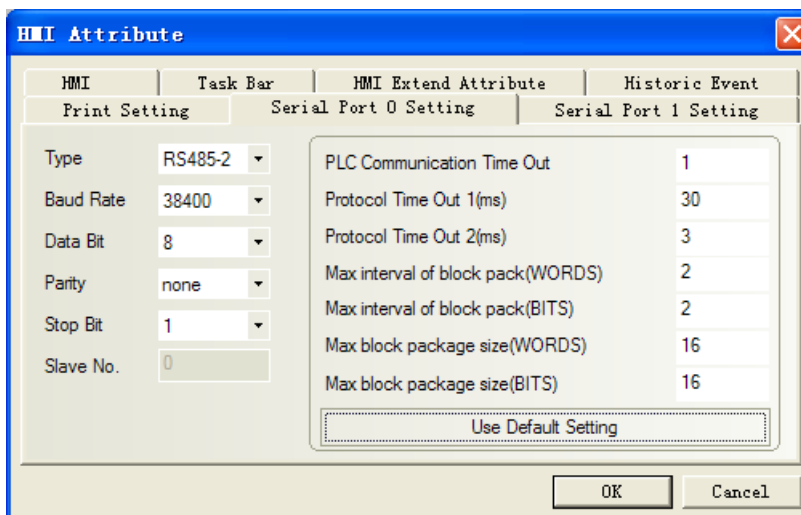

K120S KxxxS RS232 communication

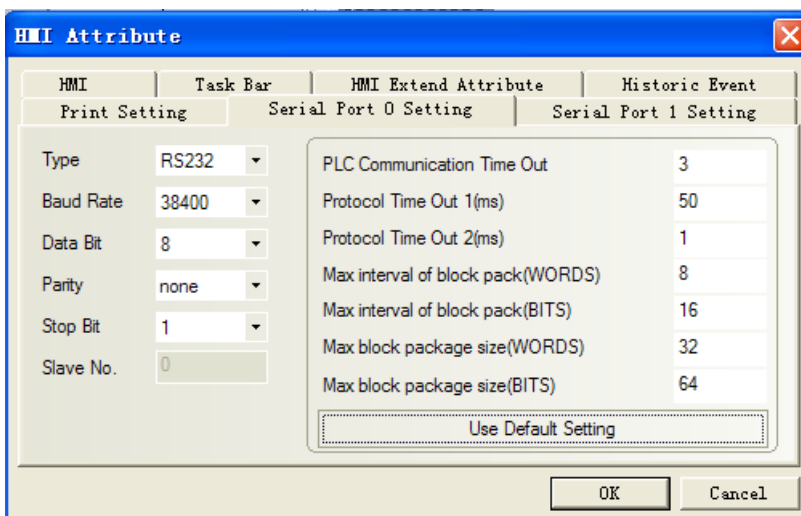

LG Modbus Rtu RS232 communication

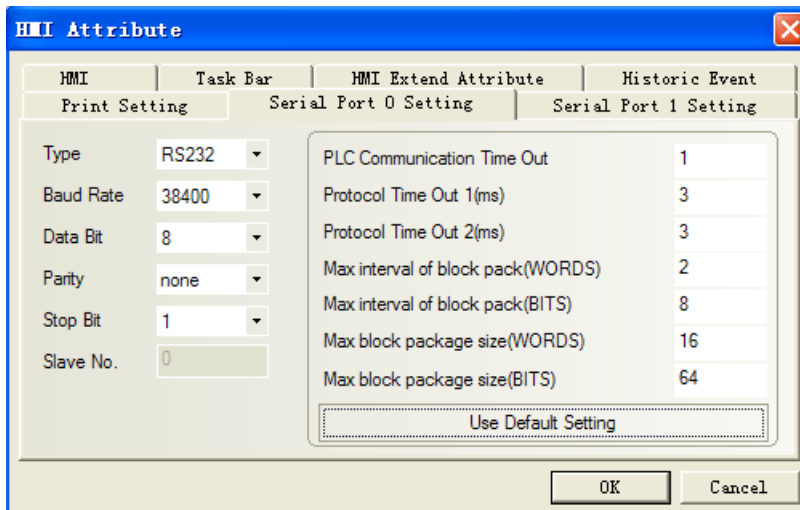

LG XGT CPU Serial protocol default communication: 115200, 8, none, 1; station number: 0
 Note: Only support 115200 buadrate for the protocol; station number disable.
RS232

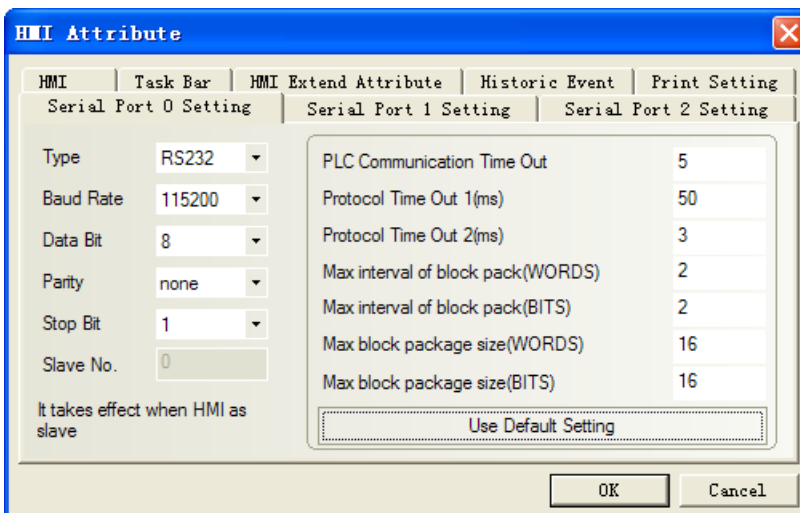

LG XGT_Cnet Series protocol default communication: 9600, 8, none, 1; station number: 0
RS232

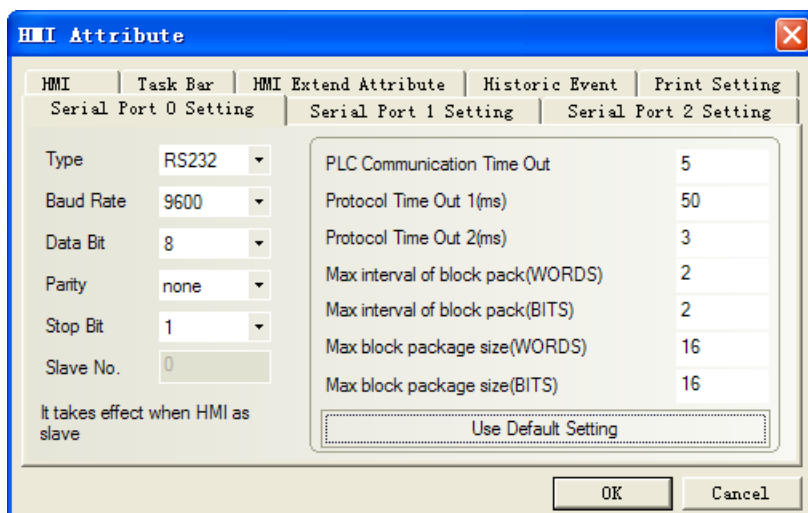

RS485

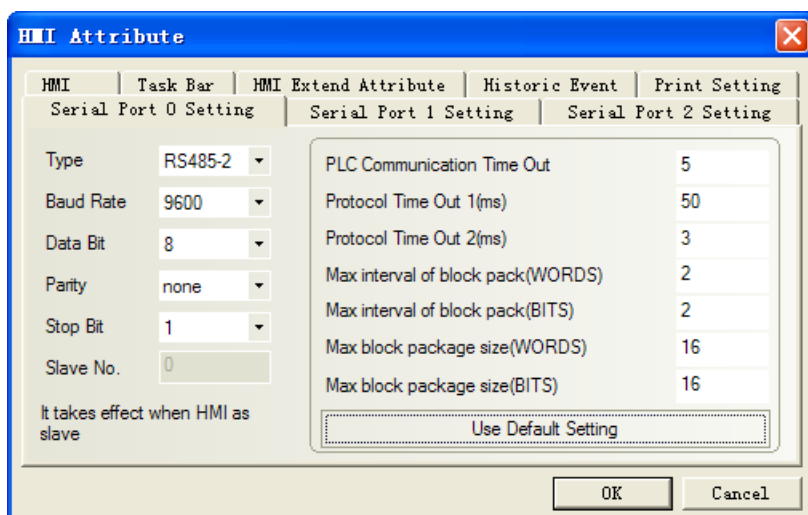

PLC software setting

1. Use the LG Master K-cnet driver, software setting as follows, pay attention to the parameter

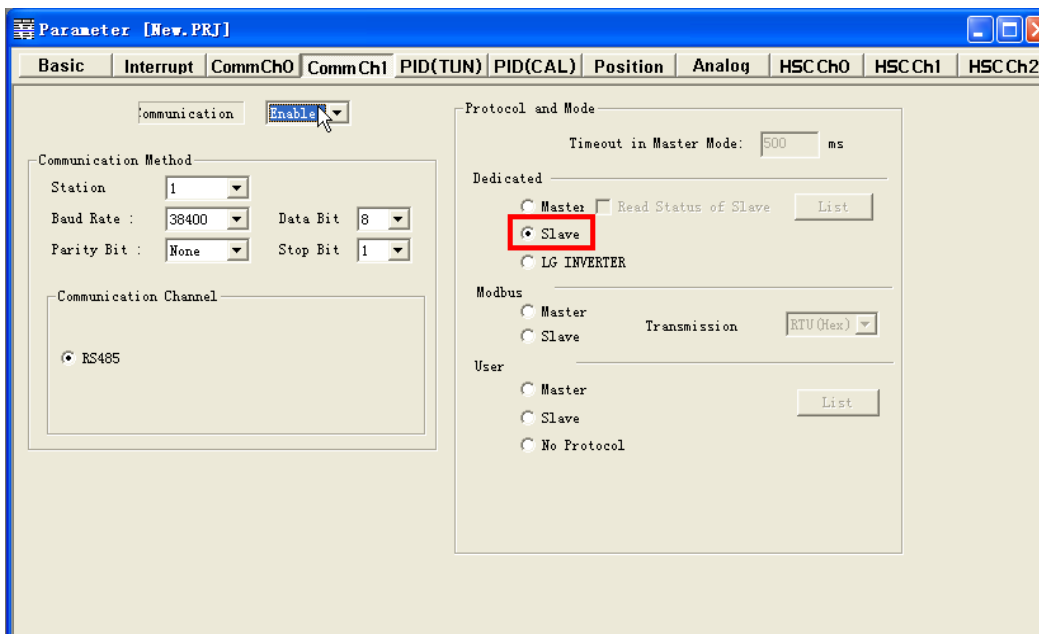

2. Use the LG Modbus Rtu driver, software setting as follows, pay attention to the parameter

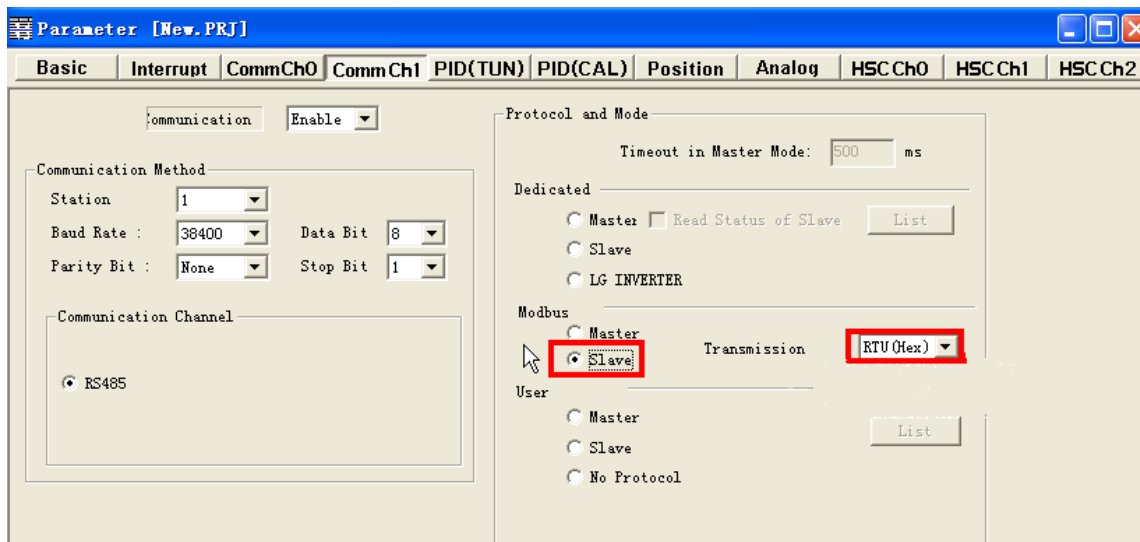

3. If click “Connect+Write+Run+Monitor Start”, it will give a “Cannot Change PLC Mode”. Need to let the run light go out by manual control, and then download. After download, let the run light keep on.

Note: connect with the software by crossover line

XG5000 software setting

1. “Tools”---“Network Manager” set communication

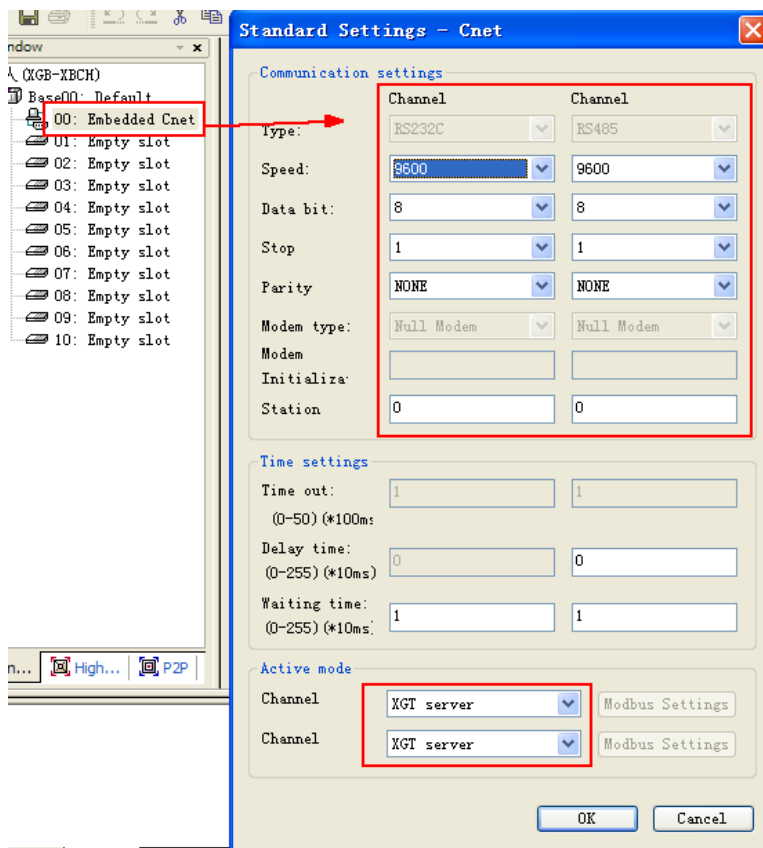

2. Communicating in the OPR mode

Supported Device

K120S K7M-DR10UE

Device	Bit Address	Word Address	Format	Notes
I/O Relay	P0.0-63.f	-----	DD.H	
Auxiliary Relay	M0.0-191.f	-----	DDD.H	
Link Relay	L0.0-63.f	-----	DD.H	
Keep Relay	K0.0-31.f	-----	DD.H	
Special Relay	F0.0-31.f		DD.H	
Timer	-----	T0-255	DDD	
Counter	-----	C0-255	DDD	
Data Register		D0-4999	DDDD	

NOTE: F address: 01 in the PLC corresponds to 0.1 in the ev5000;
 F address: 2A in the PLC corresponds to 2.A in the ev5000.
 Other register addresses, and so on.

LG XGT_Cnet Series protocol

Device	Bit Address	Word Address	Format
File Relay	R_bit 0.0-10239.F	-----	DDDDD.H
Data Relay	D_bit 0.0-10239.F	-----	DDDDD.H

Communication Relay	N_bit 0.0-5119.F	-----	DDDD.H
Link Relay	L_bit 0.0-2047.F	-----	DDDD.H
Index Relay	Z_bit 0.0-127.F	-----	DDD.H
Counter Contact Relay	C_bit 0-1023	-----	DDDD
Timer Contact Relay	T_bit 0-1023	-----	DDDD
Special Relay	F_bit 0.0-1023.F	-----	DDDD.H
Keep Relay	K_bit 0.0-4095.F	-----	DDDD.H
Auxiliary Relay	M_bit 0.0-1023.F	-----	DDDD.H
I/O Relay	P_bit 0.0-1023.F	-----	DDDD.H
File Register	-----	R_word 0-10239	DDDDD
Data Register	-----	D_word 0-10239	DDDDD
Communication Register	-----	N_word 0-5119	DDDD
Link Register	-----	L_word 0-2047	DDDD
Step Control Register		S_word 0-127	DDD
Index Register		Z_word 0-127	DDD
Counter	-----	C_word 0-1023	DDDD
Timer	-----	T_word 0-1023	DDDD
Special Register	-----	F_word 0-1023	DDDD
Keep Register	-----	K_word 0-4095	DDDD
Auxiliary Register	-----	M_word 0-1023	DDDD
I/O Register	-----	P_word 0-1023	DDDD

Note: Register T_bit and C_bit can not communicate batch

LG XGT CPU Serial protocol

Device	Bit Address	Word Address	Format
File Relay	R_bit 0.0-10239.F	-----	DDDDD.H
Data Relay	D_bit 0.0-10239.F	-----	DDDDD.H
Communication Relay	N_bit 0.0-5119.F	-----	DDDD.H
Link Relay	L_bit 0.0-2047.F	-----	DDDD.H
Index Relay	Z_bit 0.0-127.F	-----	DDD.H
	ZR_bit 0.0-10239.F	-----	DDDDD.H
Counter Contact Relay	C_bit 0-1023	-----	DDDD
Timer Contact Relay	T_bit 0-1023	-----	DDDD
Special Relay	F_bit 0.0-1023.F	-----	DDDD.H
Keep Relay	K_bit 0.0-4095.F	-----	DDDD.H
Auxiliary Relay	M_bit 0.0-1023.F	-----	DDDD.H
I/O Relay	P_bit 0.0-1023.F	-----	DDDD.H

File Register	-----	R 0-10239	DDDDD
Data Register	-----	D 0-10239	DDDDD
Communication Register	-----	N 0-5119	DDDD
Link Register	-----	L 0-2047	DDDD
Step Control Register	-----	S 0-127	DDD
Index Register	-----	Z 0-127	DDD
	-----	ZR 0-10239	DDDDD
Counter Set Value	-----	C_ SV 0-1023	DDDD
Timer Set Value	-----	T_ SV 0-1023	DDDD
Counter Current Value	-----	C_ CV 0-1023	DDDD
Timer Current Value	-----	T_ CV 0-1023	DDDD
Special Register	-----	F 0-1023	DDDD
Keep Register	-----	K 0-4095	DDDD
Auxiliary Register	-----	M 0-1023	DDDD
I/O Register	-----	P 0-1023	DDDD

Cable Diagram

K120S K-net protocol RS232 communication cable

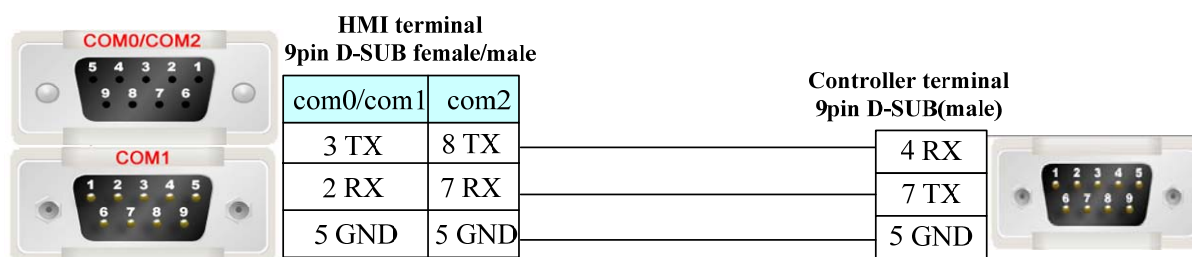

LG Modbus Rtu protocol RS232 communication cable

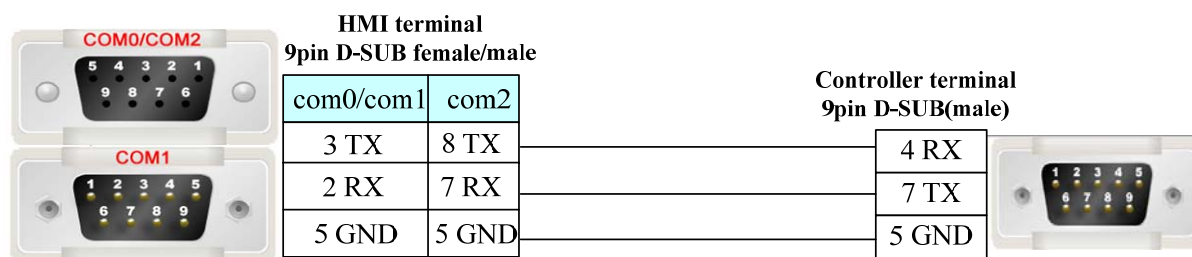

K120S KxxxS protocol RS232 communication cable

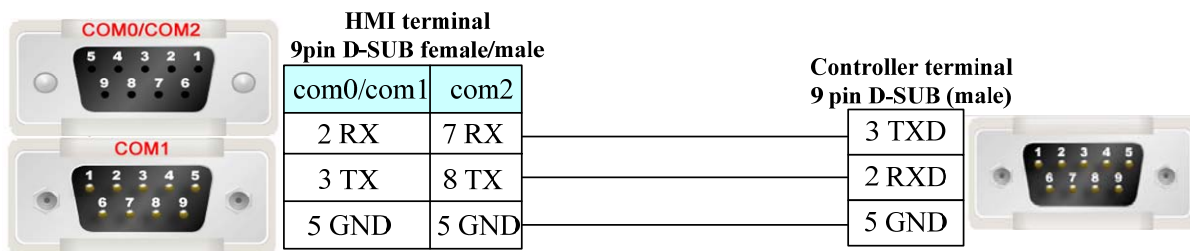

K120S K-net protocol RS485-2 communication cable

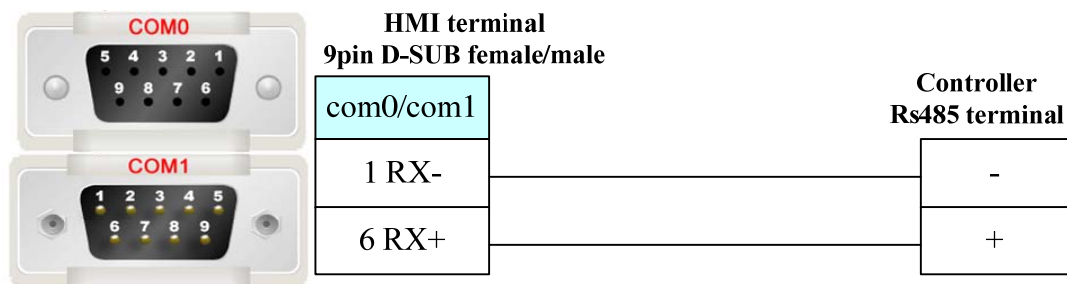

LG Modbus Rtu protocol RS485-2 communication cable

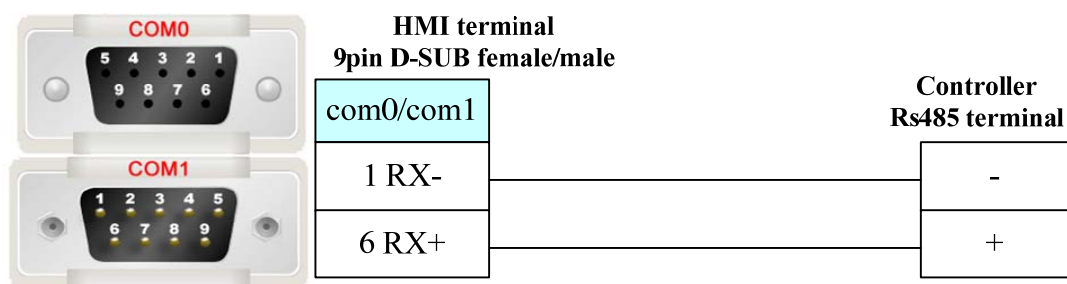

**LG XGT CPU Serial protocol
RS232 communication cable**

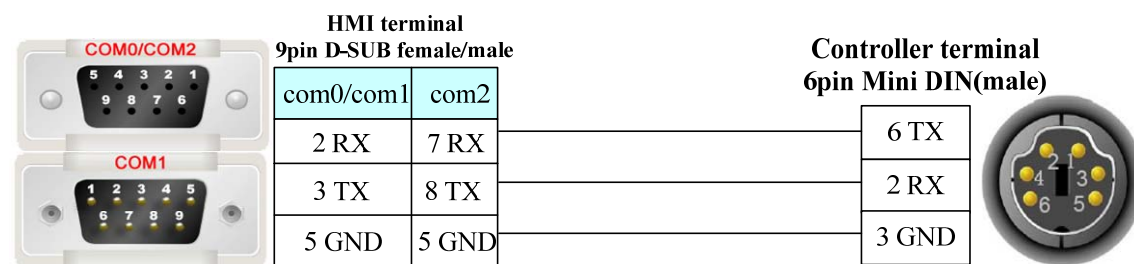

**LG XGT_Cnet Series protocol
RS232 programming cable**

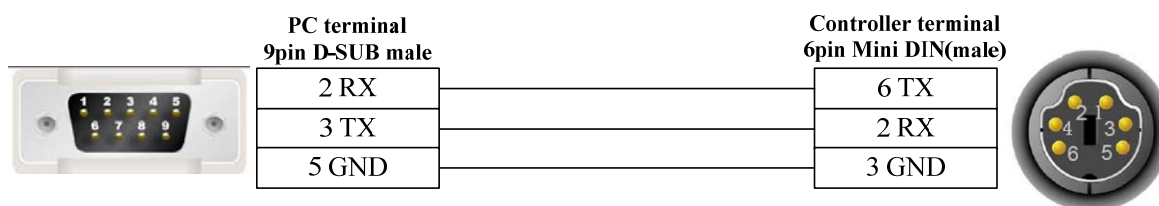

RS232 communication cable

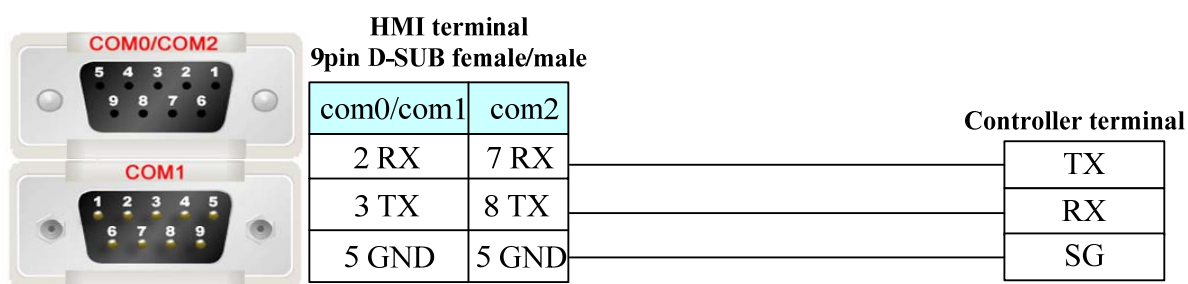

RS485 communication cable

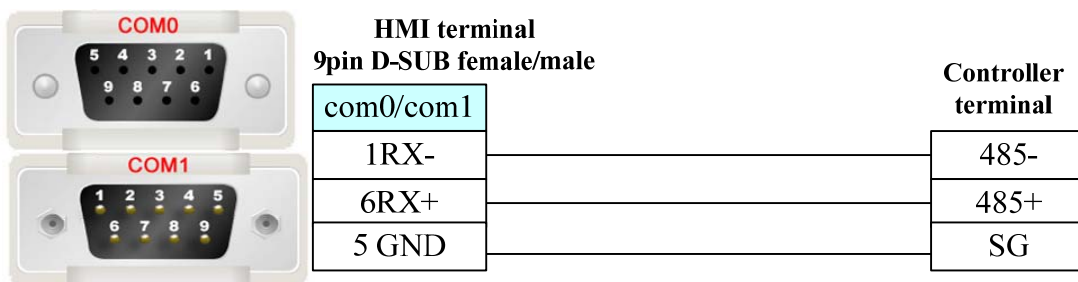

LUST BUS Inverter

Serial Communication

Series	CPU	Link Module	Driver
CDE34.008	CDE34.008	RS232 on the CPU unit	LustBus

System configuration

Series	CPU	Link Module	COM Type	Parameter	Cable
CDE34.008	CDE34.008	RS232 on the CPU unit	RS232	Setting	Your owner cable

Communication Setting

Lustbus RS232 default communication: 57600, 7, even, 1; station: 1

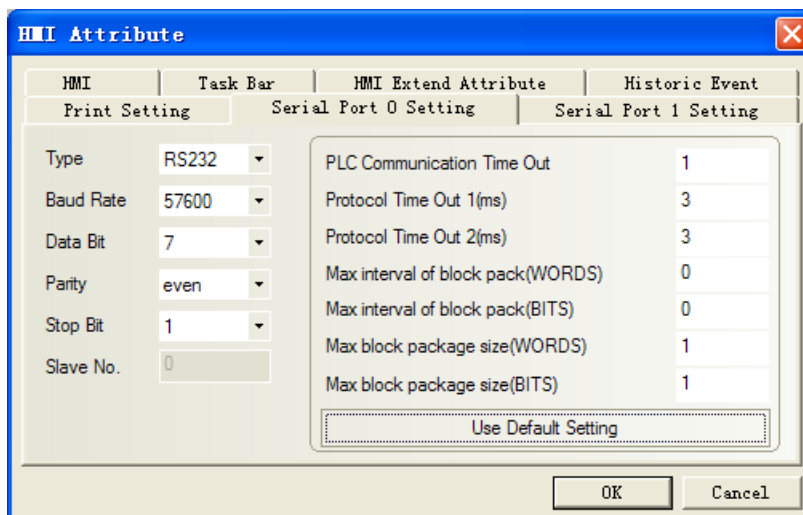

Supported Device

Refer to the Controller software for details: DriveManager for c-line drives

Cable Diagram

Lustbus RS232 communication cable

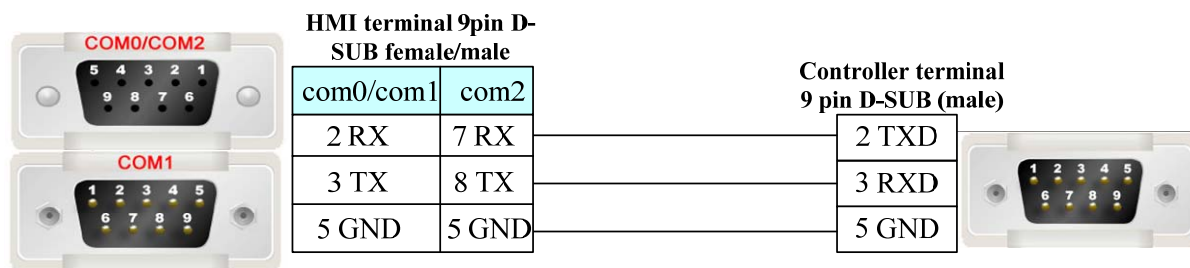

Matsushita Electric Corporation

Serial Communication

Series	CPU	Link Module	Driver
FP	FP Σ	Tool port on the Control unit	Matsushita FP
		AFPG801	
		AFPG802	
		AFPG803	
	FP0	Tool port on the Control unit	
	FP1	RS232C port on the Control unit	
	FP-M		
FP2	Tool port on the Control unit		

	FP2SH	RS232C port on the Control unit	
		AFP2462	
		AFP2465+(AFP2803,AFP2804, FP2805)	
	FP3	Tool port on the Control unit	
		AFP3462	
	FP-e	Tool port on the Control unit	
		AFPE224300	
		AFPE224302	
		AFPE224305	
		AFPE214322	
	FP10SH FP10S	Tool port on the Control unit	
		RS232C port on the Control unit	
		AFP3462	
	FP-X	RS232C port on the Control unit	

System configuration

Series	CPU	Link Module	COMM Type	Parameter	Cable
FP	FP	Tool port on the Control unit	RS232C	Setting	Your owner cable
		AFPG801			Your owner cable
		AFPG802			
		AFPG806			
		AFPG803			
	FP0	Tool port on the Control unit	RS232C	Setting	Your owner cable
		RS232C port on the Control unit			Your owner cable
	FP1	Tool port on the Control unit	RS232C	Setting	Your owner cable
	FP-M	RS232C port on the Control unit			Your owner cable
	FP2 FP2SH	Tool port on the Control unit	RS232C	Setting	Your owner cable
		RS232C port on the Control unit			Your owner cable
		AFP2462			
		AFP2465			
	AFP2804		RS485(2 wire)	Setting	Your owner cable
	AFP2805				
	FP3	Tool port on the Control unit	RS232C	Setting	Your owner cable
		AFP3462			Your owner cable
		AFP3463	RS422(4 wire)	Setting	Your owner cable
	FP-e	Tool port on the Control unit	RS232C	Setting	Your owner cable
		AFPE224300	RS232C		Your owner cable
AFPE214325					
AFPE224305					
AFPE224302		RS485(2 wire)			

		AFPE214322			
FP10SH FP10S		Tool port on the Control unit	RS232C	Setting	Your owner cable
		RS232C port on the Control unit			Your owner cable
		AFP3462			
FP-X		RS232C port on the Control unit	RS232C	Setting	Your owner cable

Note:

1. Only FP0 (C10CRM/C10CRS/C14CRM/C14CRS/C16T/C16CP/C32CT/C32CP) has RS232C port.
2. Only FP1 (C24/C40/C56/C72) has RS232C port.
3. Only FP1(C20R/C20T/C32T)has RS232C port.
4. AFP245 is the communication Package of FP2/FP2SH. AFP2803, AFP2084 and AFP2085 are the communications module of AFP2465.

Communication Setting

RS232 communication

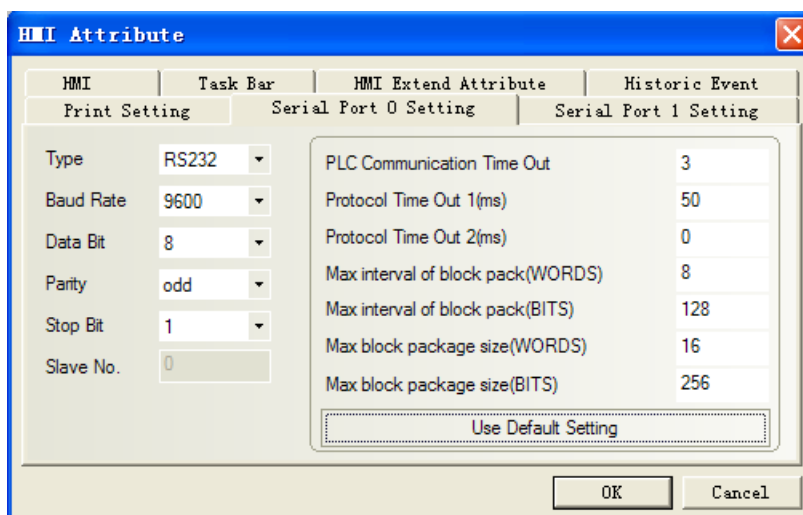

RS485 communication

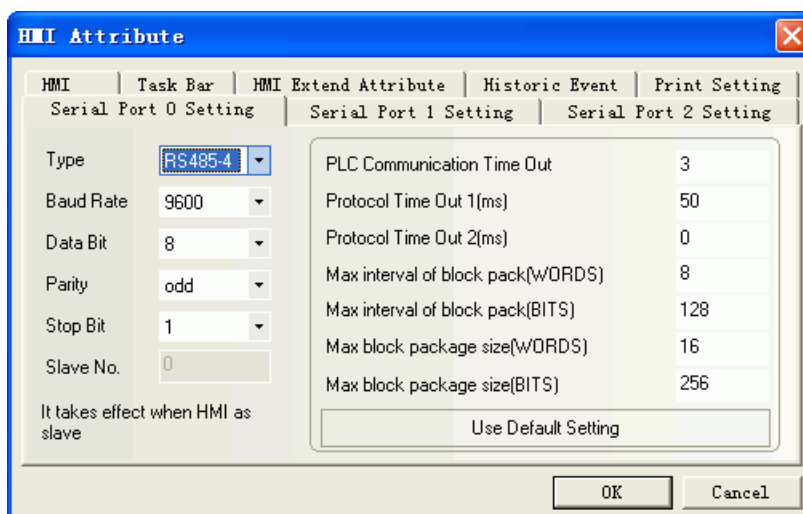

RS422 communication

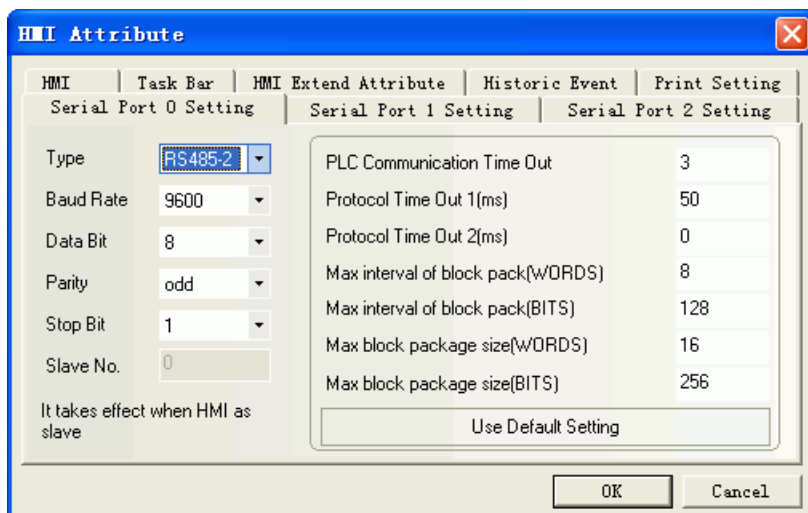

Supported Device

FP0-C16

Device	Bit Address	Word Address	Format	Notes
Input(X) Relay	Y0.0-12.F	-----	DD.H	
Output(Y) Relay	X0.0-12.F	-----	DD.H	
Timer(T) Relay	T0-99	-----	DD	
Counter(C) Relay	C100-143	-----	DDD	
Internal Relay(R)	R0.0-62.F R900.0-903.F	-----	DD.H DDD.H	
Timer/Counter set value(SV)	-----	SV0-143	DDD	
Timer/Counter elapse value(EV)	-----	EV0-143	DDD	
Data Register(DT)	-----	DT0-1659	DDDD	

FPX

Device	Bit Address	Word Address	Format	Notes
Input(X) Relay	X0.0~109.F	-----	DDD.H	
Output(Y) Relay	Y0.0~109.F	-----	DDD.H	
Timer(T) Relay	T0~1007	-----	DDDD	
Counter(C) Relay	C1008~1023	-----	DDDD	
Link Relay(L)	L0.0~127.F	-----	DDD.H	
Internal Relay(R)	R0.0~255.F R900.0~911.F	-----	DDD.H	
Timer/Counter set value(SV)	-----	EV0~1023	DDDD	
Timer/Counter elapse value(EV)	-----	SV0~1023	DDDD	
Data Register(DT)	-----	DT0~32764	DDDDD	

Note:

- 1). Example: X address: 01 in the PLC corresponds to 0.1 in the EV5000; X address: 1F in the

PLC corresponds to 1.F in the EV5000.Y\R register address, and so on.

2). EV Register address in the touch screen can be set up to 32,767, but only support to 9999 in the protocol.

Cable Diagram

FP RS232 communication

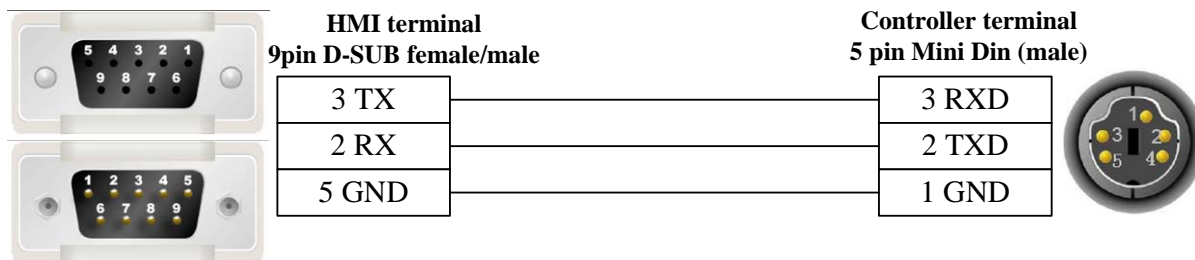

RS232 communication

Tool port:

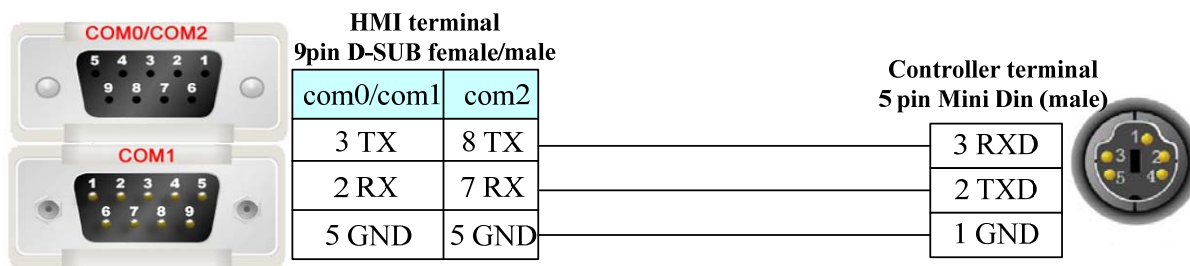

CPU port:

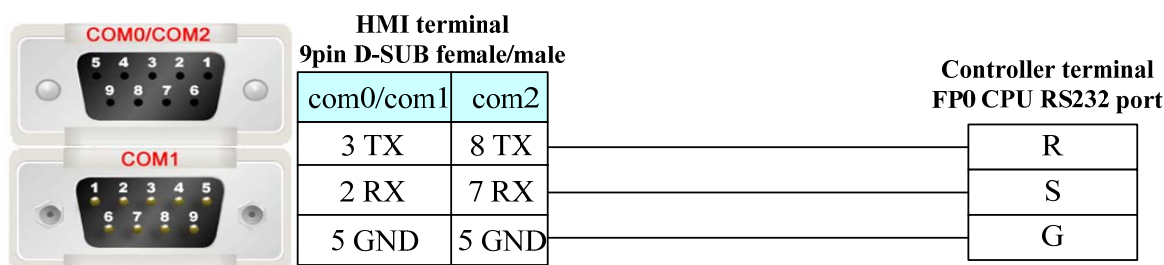

Module port:

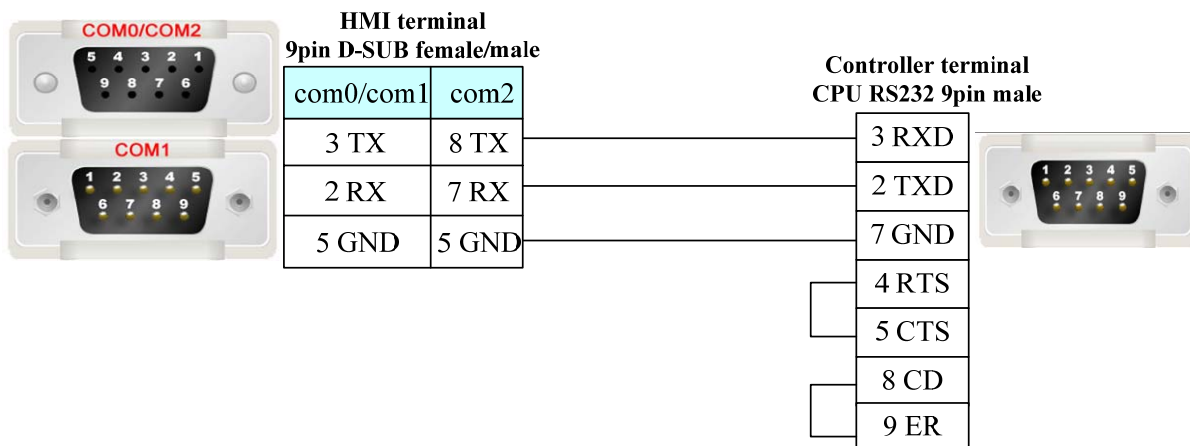

RS485 communication

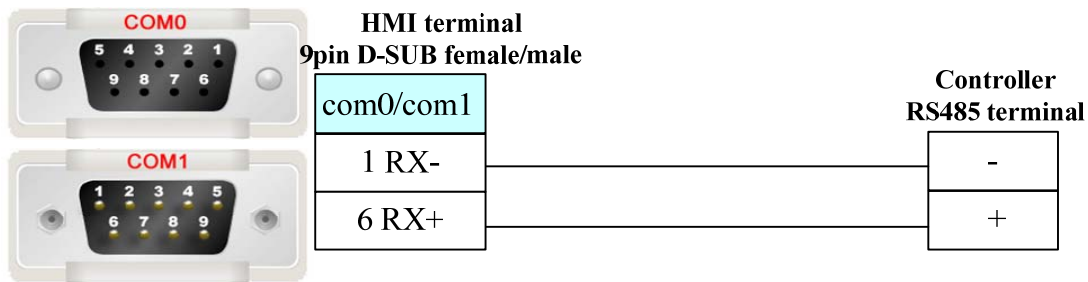

RS422 communication

FP3 RS422 programming port:

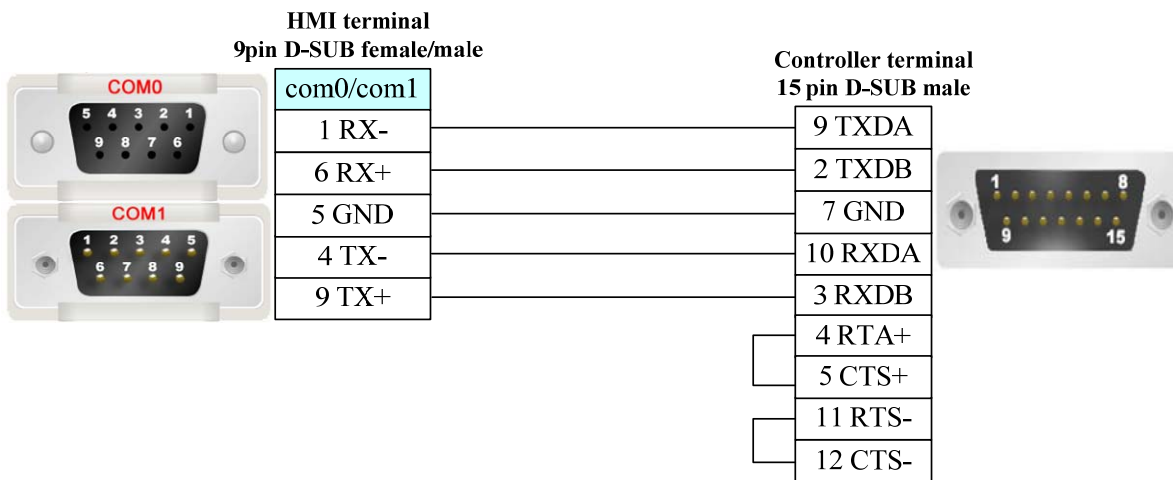

Another module RS422 communication:

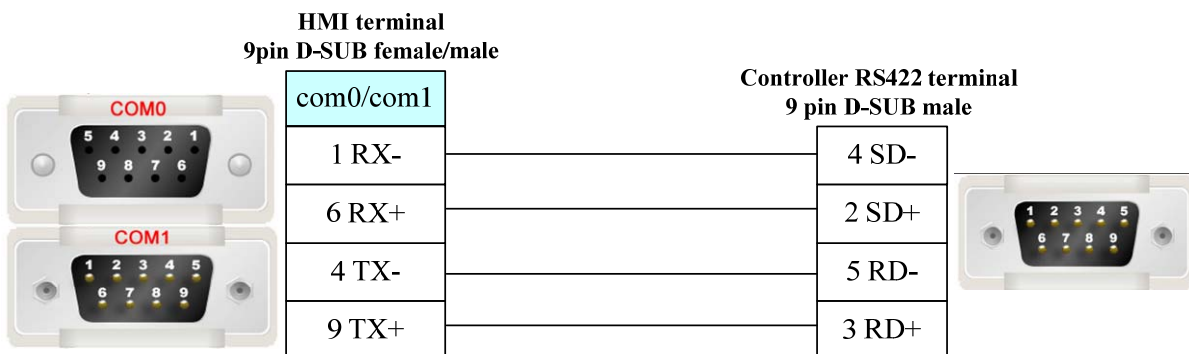

Memory map

Serial Communication

Series	CPU	Link Module	Driver
BMS005A-MC11	BMS005A-MC11	RS422 on the CPU unit	MemoryMap(Master-Slave)

System configuration

Series	CPU	Link Module	COMM Type	Parameter	Cable
--------	-----	-------------	-----------	-----------	-------

BMS005A-MC11	BMS005A-MC11	RS422 on the CPU unit	RS422	Setting	Your owner cable
--------------	--------------	-----------------------	-------	-------------------------	----------------------------------

Communication Setting

HMI

BMS005A default communication: 57600, 8, none, 1; station number: 1

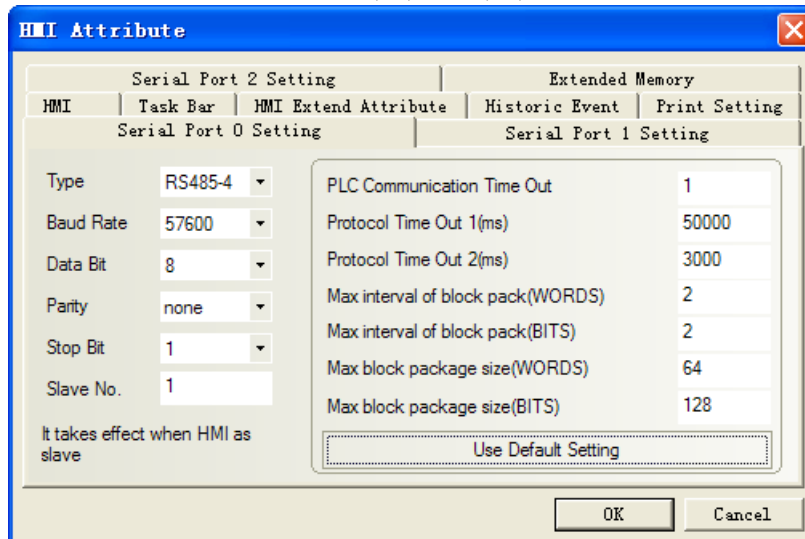

Supported Device

Device	Bit Address	Word Address	Format
	LW.B 8000.0-8999.15	-----	DDDD.DD
	-----	LW8000-8999	DDDD

Cable Diagram

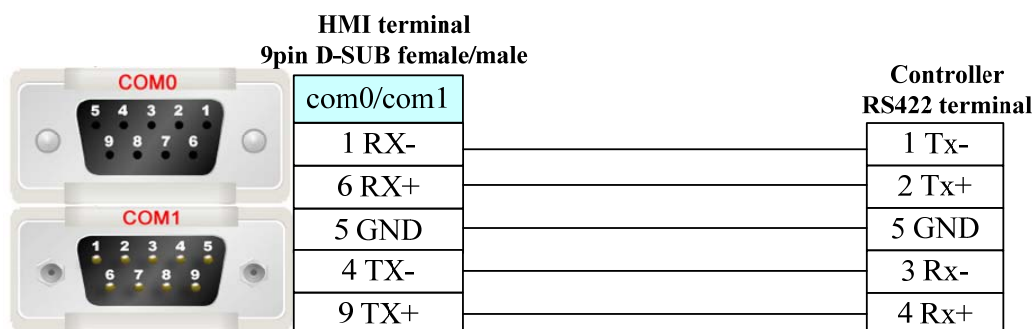

Mitsubishi Electric Corporation

Serial Communication

Series	CPU	Link Module	Driver
FXCPU	Fx0n	RS232 on the CPU unit	Mitsubishi FX0N/1N/2N
		RS485 on the CPU unit	
		RS485 Module	Mitsubishi FX0N/1N/2N Mitsubishi FX-485ADP/422BD (Multi-station)* ¹
	Fx1n	RS232 on the CPU unit	Mitsubishi FX0N/1N/2N
		RS485 on the CPU unit	
		RS485 Module	Mitsubishi FX0N/1N/2N Mitsubishi FX-485ADP/422BD (Multi-station)* ¹
	Fx1s	RS232 on the CPU unit	Mitsubishi FX1s
		RS485 on the CPU unit	
		RS485 Module	Mitsubishi FX1s Mitsubishi FX-485ADP/422BD (Multi-station)
	Fx2n	RS232 on the CPU unit	Mitsubishi FX0N/1N/2N
		RS485 on the CPU unit	
		RS485 Module	Mitsubishi FX0N/1N/2N Mitsubishi FX-485ADP/422BD (Multi-station)* ¹
Fx2N-10GM Fx2N-20GM	RS232 on the CPU unit	Mitsubishi FX2N_10GM/20GM	
	RS485 on the CPU unit		
Fx3u	RS232 on the CPU unit	Mitsubishi FX3u	
	RS485 on the CPU unit		
	FX3U-485-BD	Mitsubishi FX3u Mitsubishi FX-485ADP/422BD (Multi-station)* ¹	
Fx3G-60M	RS485 on the CPU unit	Mitsubishi FX0N/1N/2N	
QCPU	Q00jCPU	RS232 on the CPU unit	Mitsubishi Q00J (CPU Port)
		QJ71C24	Mitsubishi Q_QnA (Link Port)
		QJ71C24-R2	
		QJ71C24N	
		QJ71C24N-R2	
	QJ71C24N-R4		
Q00CPU Q01CPU	RS232 on the CPU unit	Mitsubishi Q_QnA (Link Port)	
	QJ71C24		
	QJ71C24-R2		
	QJ71C24N		
	QJ71C24N-R2		
QJ71C24N-R4			
Q02CPU Q02HCPU Q06HCPU Q12HCPU Q25HCPU	RS232 on the CPU unit	Mitsubishi Q series (CPU Port)	
	QJ71C24	Mitsubishi Q_QnA (Link Port)	
	QJ71C24-R2		
	QJ71C24N		
	QJ71C24N-R2		
QJ71C24N-R4			

Note: 1. Don't live plug!

2. *¹ support multi station**System configuration**

Series	CPU	Link Module	COMM Type	Parameter	Cable
Melsec FX	Fx0n	RS232 on the CPU unit	RS232	Setting	Your owner cable
		RS485 Module	RS485-4	Setting	Your owner cable
	Fx1n	RS232 on the CPU unit	RS232	Setting	Your owner cable
		RS485 Module	RS485-4	Setting	Your owner cable
	Fx1s	RS232 on the CPU unit	RS232	Setting	Your owner cable
		RS485 on the CPU unit	RS485-4	Setting	Your owner cable
		RS485 Module	RS485-4	Setting	Your owner cable
	Fx2n	RS232 on the CPU unit	RS232	Setting	Your owner cable
		RS485 on the CPU unit	RS485-4	Setting	Your owner cable
		RS485 Module	RS485-4	Setting	Your owner cable
	Fx2N-10GM	RS232 on the CPU unit	RS232	Setting	Your owner cable
	Fx2N-20GM	RS485 on the CPU unit	RS485-4	Setting	Your owner cable
	Fx3uc	RS232 on the CPU unit	RS232	Setting	Your owner cable
		RS485 on the CPU unit	RS485-4	Setting	Your owner cable
		RS485 Module	RS485-4	Setting	Your owner cable
Melsec Q	Q00jCPU	RS232 on the CPU unit	RS232	Setting	Your owner cable
		QJ71C24	RS485-4	Setting	Your owner cable
		QJ71C24-R2			
		QJ71C24N			
		QJ71C24N-R2			
	QJ71C24N-R4				
	Q00CPU Q01CPU	RS232 on the CPU unit	RS232	Setting	Your owner cable
		QJ71C24	RS485-4	Setting	Your owner cable
		QJ71C24-R2			
		QJ71C24N			
		QJ71C24N-R2			
	QJ71C24N-R4				
Q02CPU Q02HCPU Q06HCPU Q12HCPU Q25HCPU	RS232 on the CPU unit	RS232	Setting	Your owner cable	
	QJ71C24	RS485-4	Setting	Your owner cable	
	QJ71C24-R2				
	QJ71C24N				
	QJ71C24N-R2				
QJ71C24N-R4					

Communication Setting

FX 1s protocol default communication: 9600, 7, even, 1; station: 0
RS232 communication

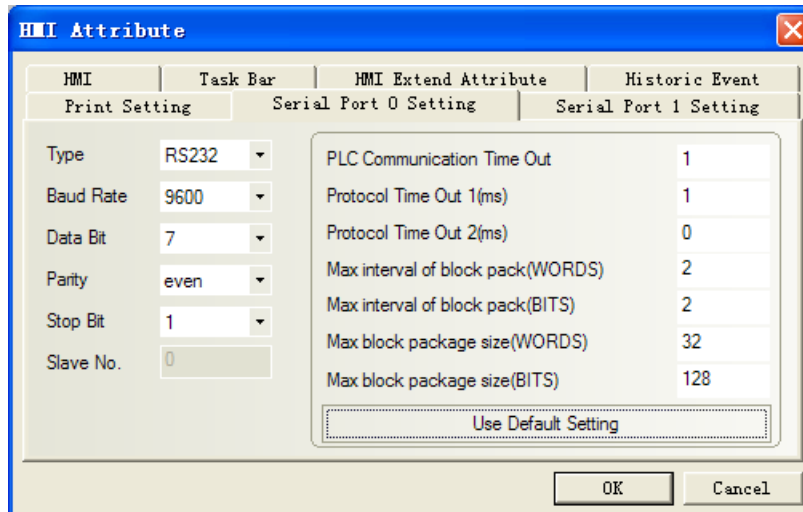

RS422 communication

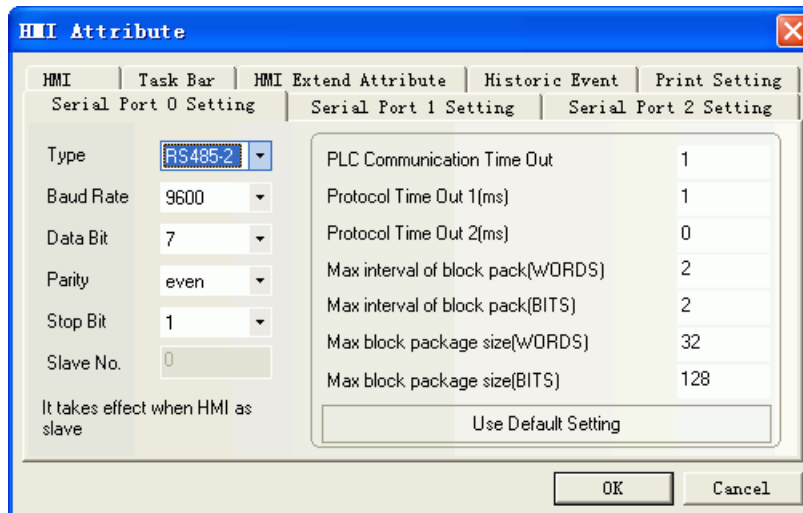

Select default parameter for plc

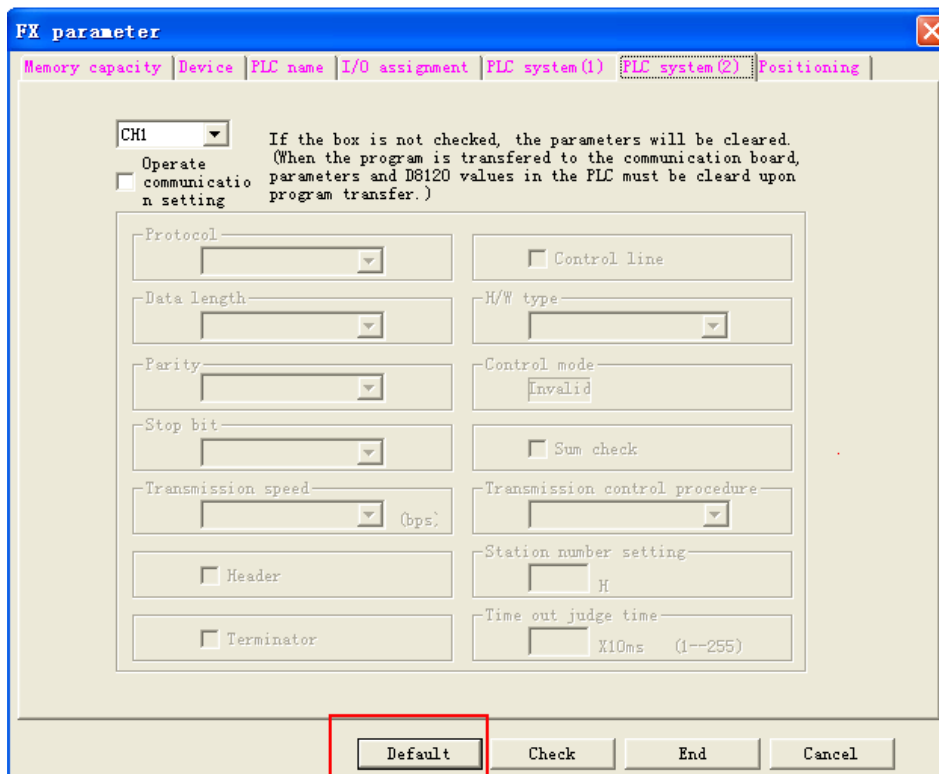

FX 2n default communication: 9600, 7, even, 1; station: 0
 RS232 communication

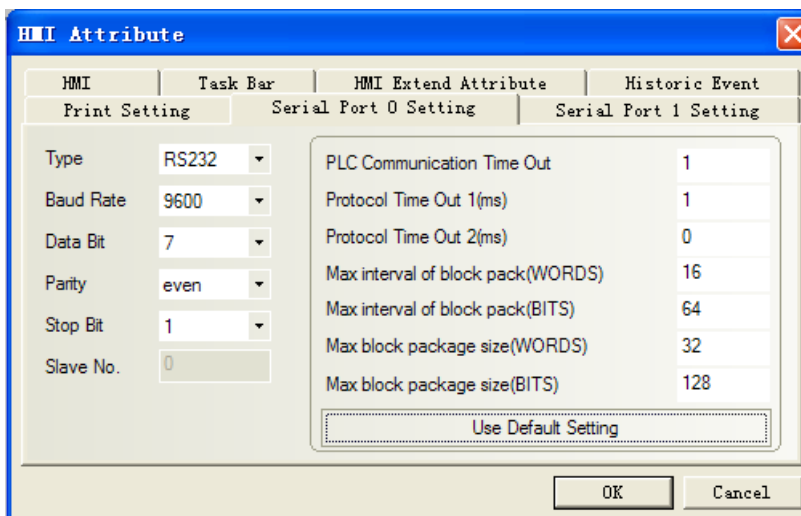

RS422 communication

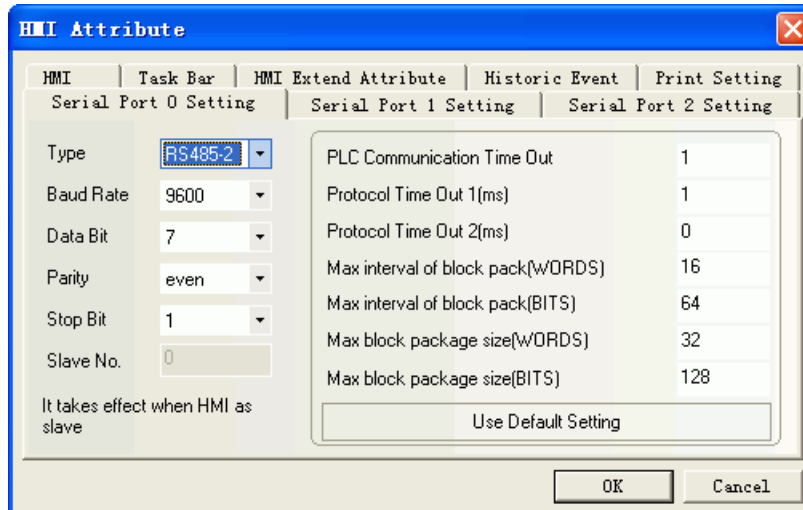

Fx2N-10G/20GM default communication: 9600, 8, even, 1; station: 0
 RS232 communication

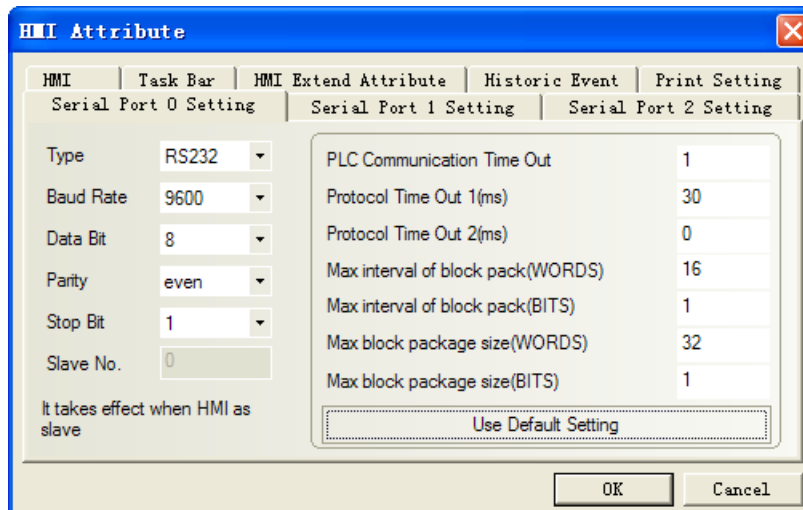

RS422 communication

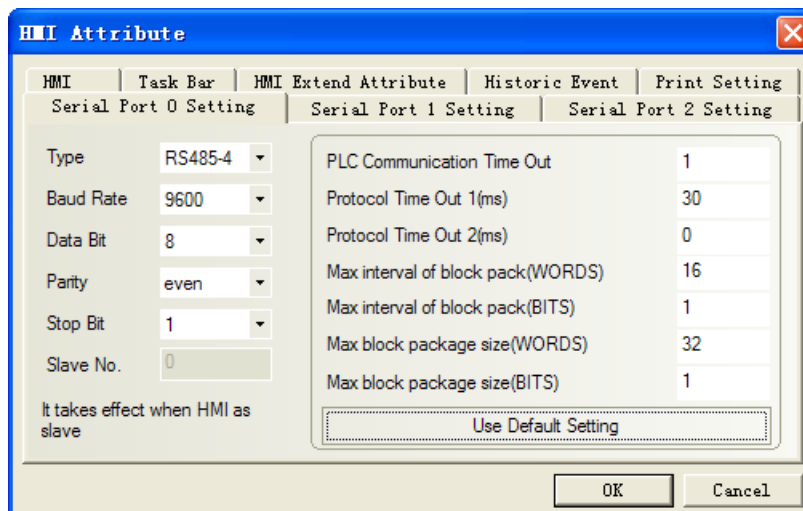

FX 3u default communication: 9600, 7, even, 1; station: 0
 RS232 communication

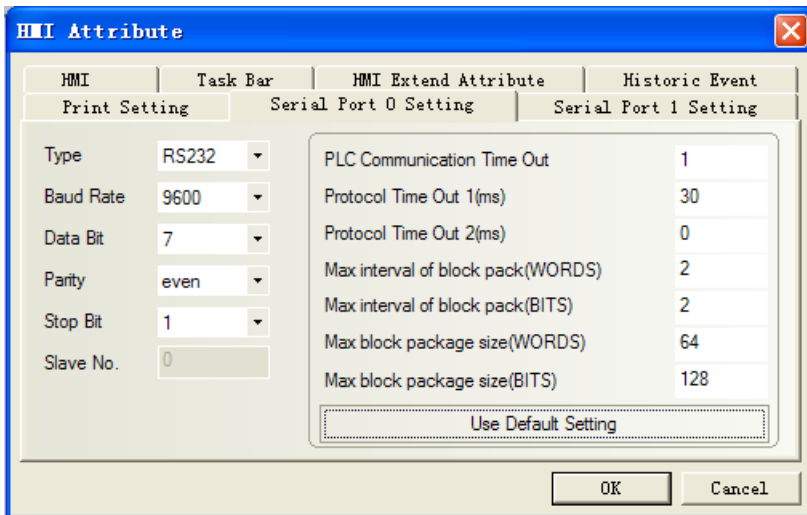

RS422 communication

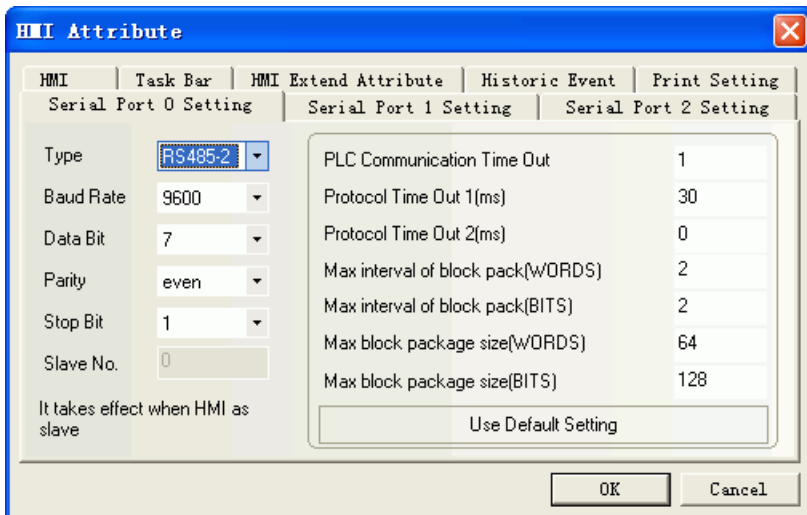

FX Serial RS422 Computer Link default communication: 19200, 7, even, 2; station: 0
 (support multi station)

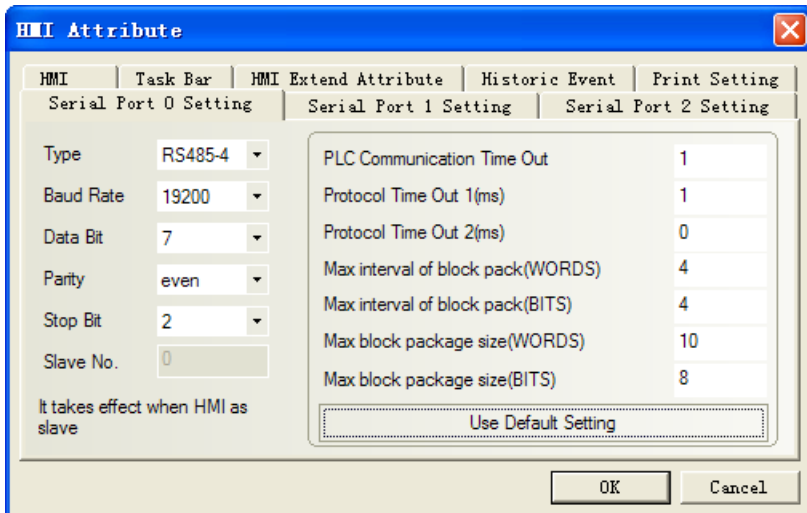

PLC Software Setting:

Note: Must modify the value of special data register.

Set D8120=OXEO9E;

D8121=0;

D8129=1;

Download and PLC restart.

Q00j series RS232 communication

Note:

- 1、HMI default parameter: 19200, 8, odd, 1.
- 2、PLC station No.:0 (Non-support station number, only one HMI connect to one PLC) .
- 3、If communication baudrate is error, HMI automatically set PLC baudrate for the HMI baudrate. It is not necessary to consider whether the PLC communications baudrate being true.
- 4、This drives support password protection model Q00J.

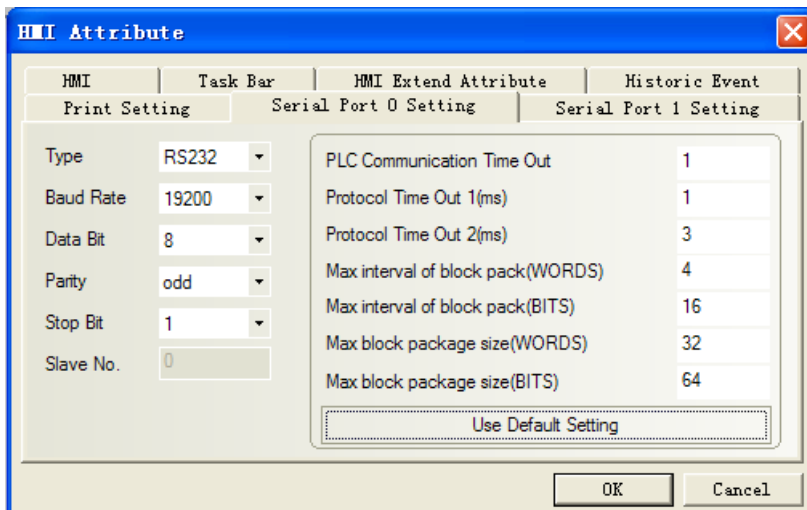

Q00 series default communication: 9600, 8, odd, 1; station: 0
 RS232 communication

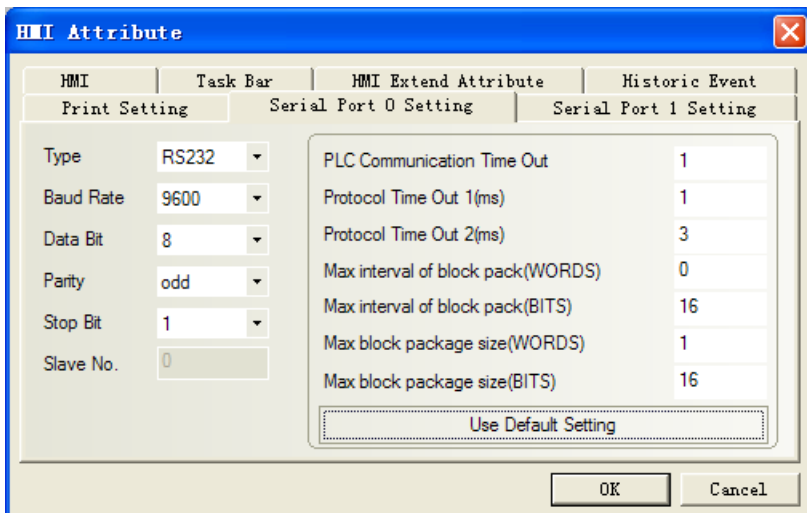

RS485 communication

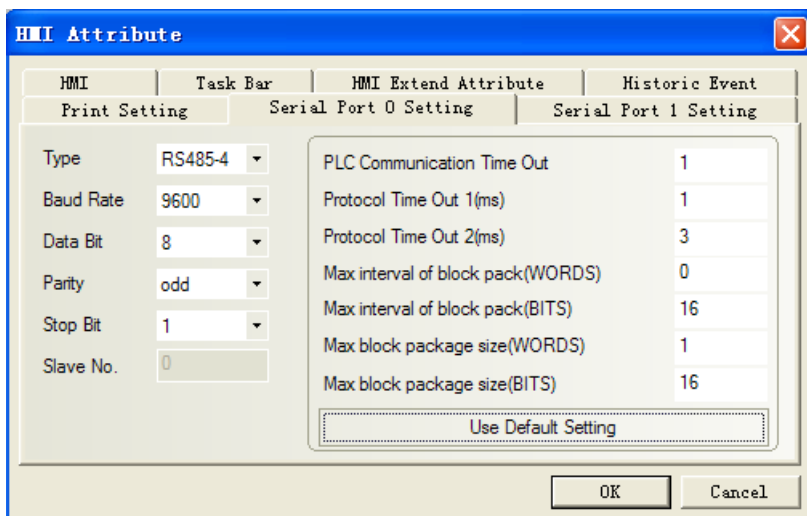

Q00、Q01 PLC communication setting

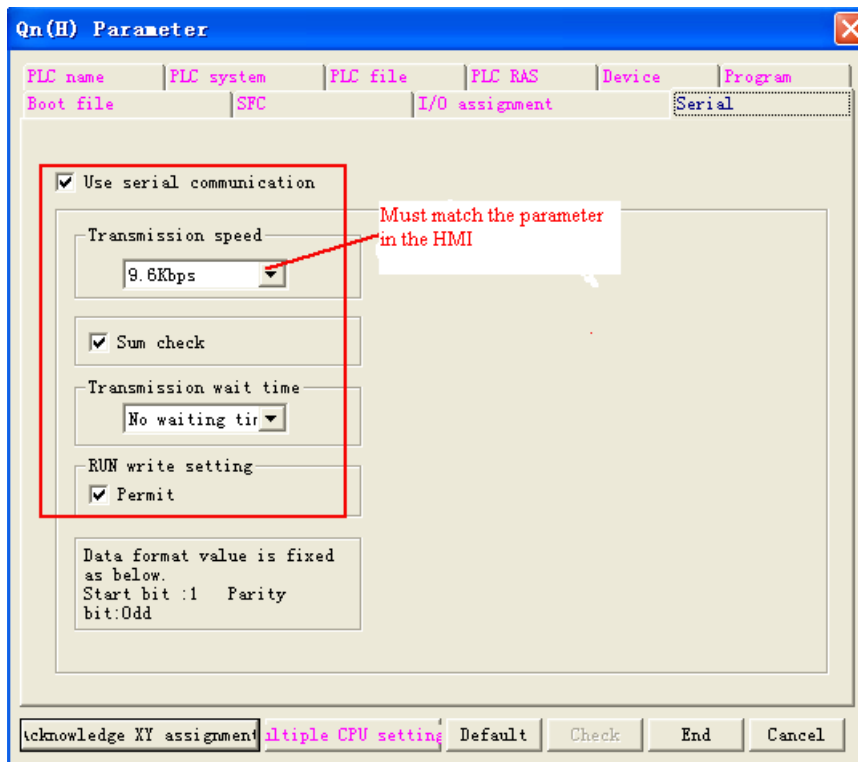

Q02 series CPU port communication

- 1.HMI Default: 115200, 8, odd, 1
2. PLC Station No.: 0 (one HMI communicate with one PLC)
- 3.If baud rate is wrong, HMI will set the baud rate of PLC the same as HMI.

RS232 communication

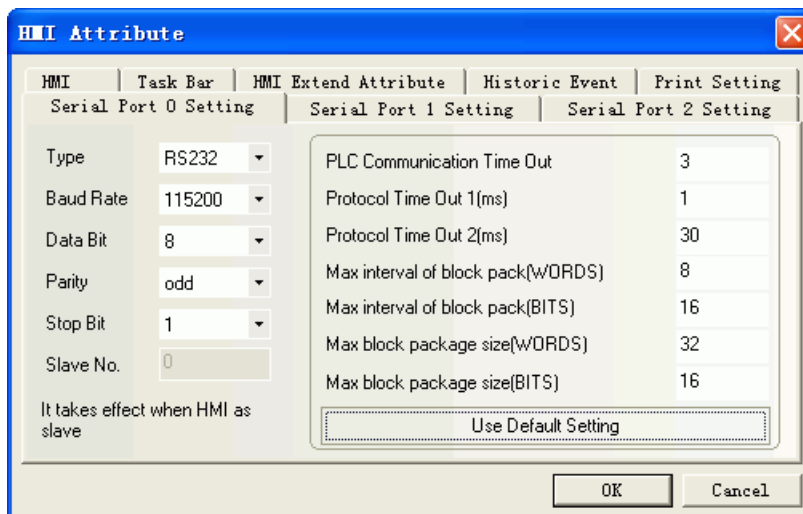

RS422 communication (Choose Mitsubishi Q_QnA (Link Port))

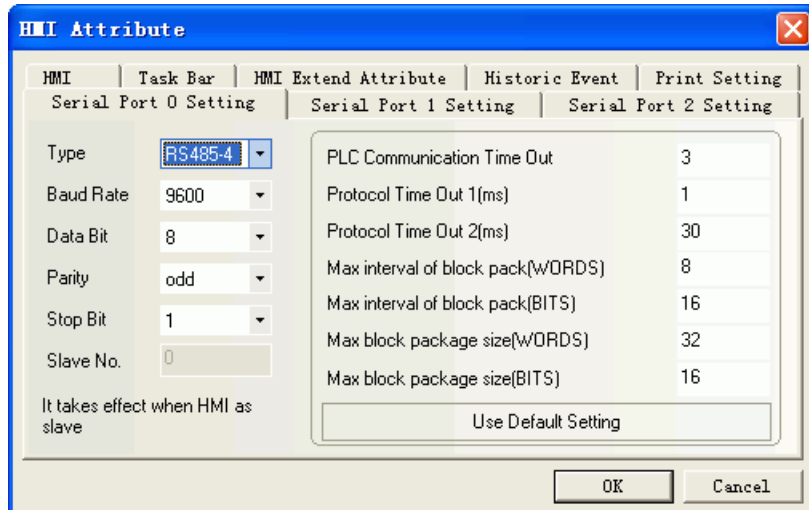

Q02 series module communication (Choose Mitsubishi Q_QnA (Link Port))

Baud rate, Parity and Station No. are modifiable.

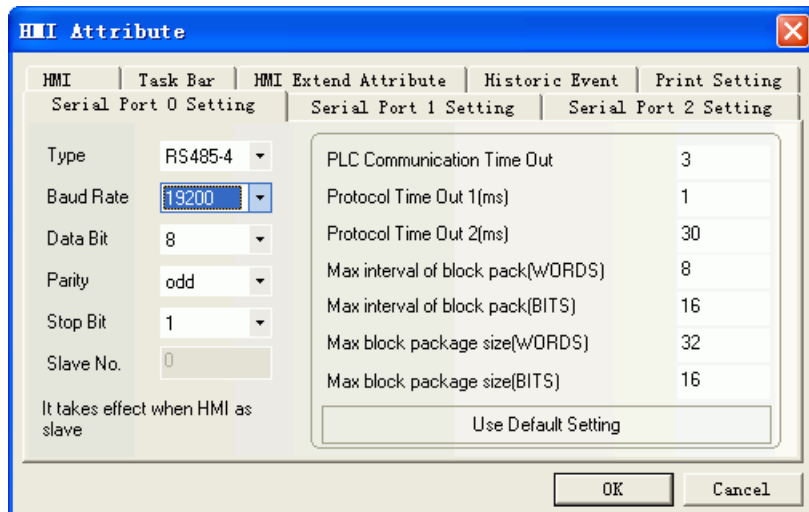

PLC Software Setting:

- a. "parameter" double-click "plc parameter", select "I/O assignment".

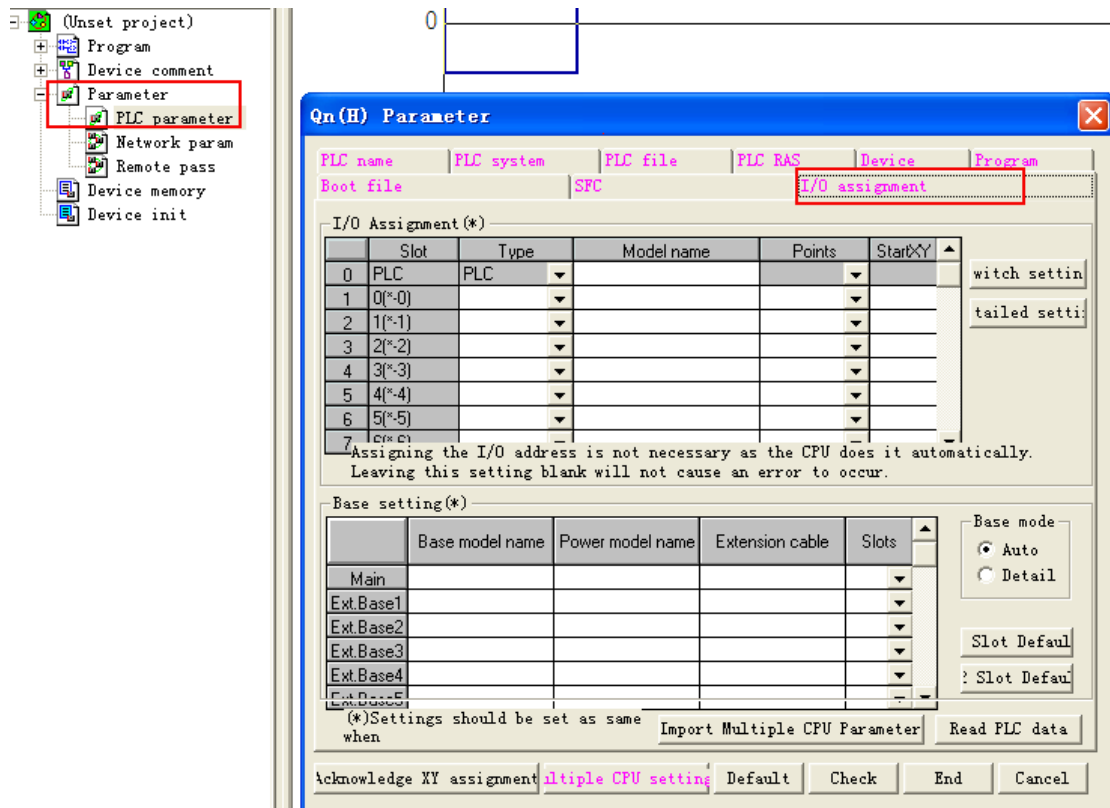

b. click "type" to select "intelligent"

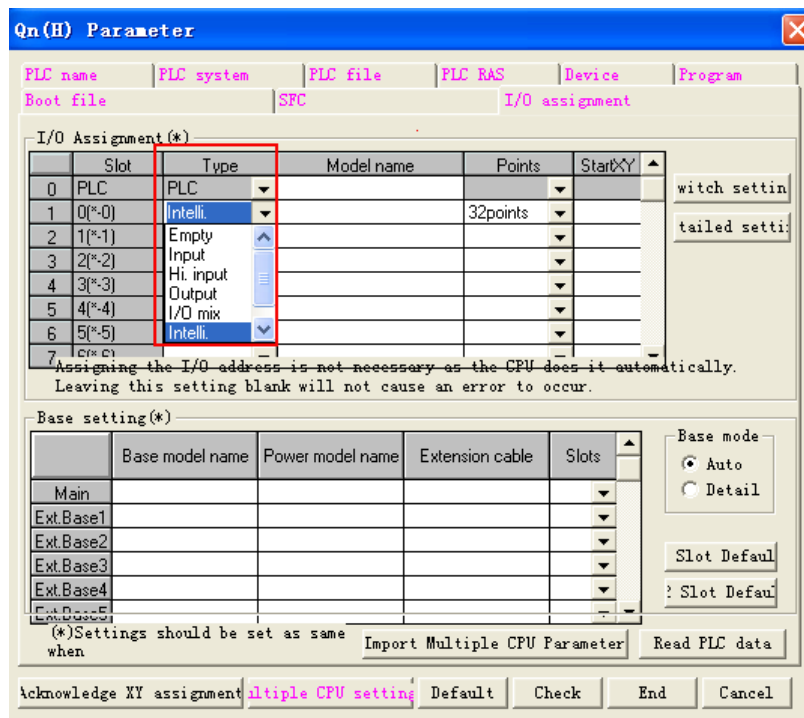

c. click "switch setting" and set

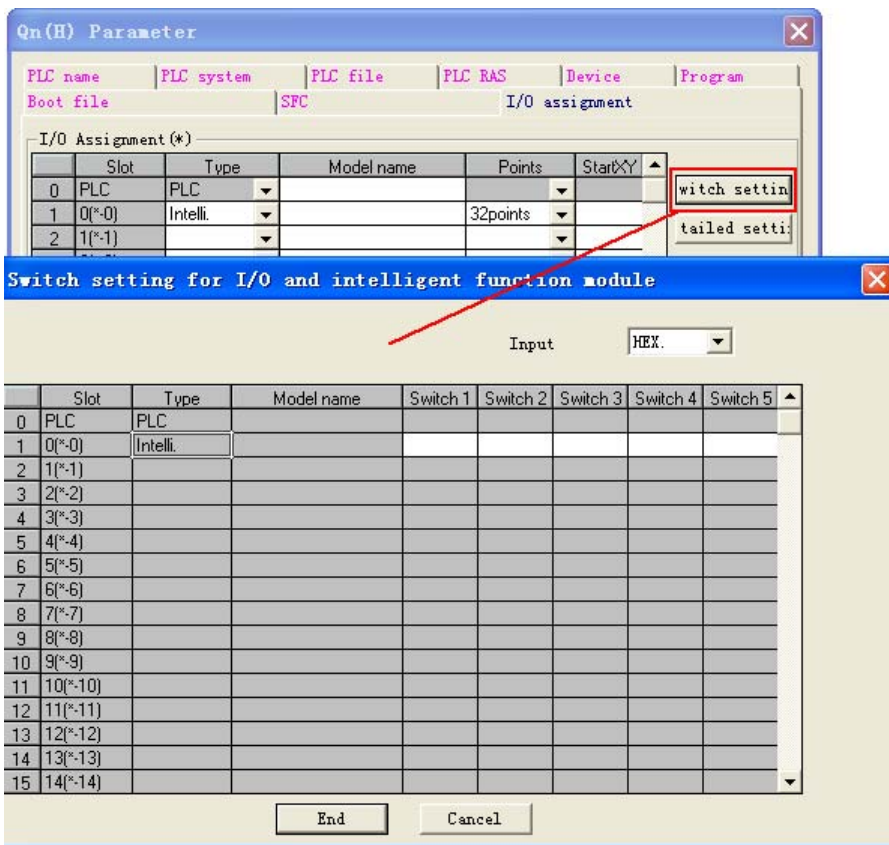

Setting Switch	Setting Value	Setup Description
Switch 1	07E6	19200/8/With/Odd/1
Switch 2	0005	Mode = Form 5
Switch 5	0000	Station No. = 0

switch	content	example																																																		
Switch1	CH1:transmission rate, transmission setting Bit 15 ~ 8 7 ~ 0 <div style="display: flex; justify-content: space-around; align-items: center;"> <div style="text-align: center;"> <table border="1"> <thead> <tr> <th>bps</th> <th>value</th> </tr> </thead> <tbody> <tr><td>4800</td><td>04H</td></tr> <tr><td>9600</td><td>05H</td></tr> <tr><td>19200</td><td>07H</td></tr> <tr><td>38400</td><td>09H</td></tr> <tr><td>57600</td><td>0AH</td></tr> <tr><td>1E+05</td><td>0BH</td></tr> </tbody> </table> </div> <div style="text-align: center;"> <table border="1"> <thead> <tr> <th>Bit</th> <th>content</th> <th>OFF</th> <th>ON</th> </tr> </thead> <tbody> <tr><td>0</td><td>Motion Setting</td><td>inching</td><td>cont</td></tr> <tr><td>1</td><td>data bit</td><td>7</td><td>8</td></tr> <tr><td>2</td><td>parity check bit</td><td>N</td><td>Y</td></tr> <tr><td>3</td><td>parity check</td><td>odd</td><td>even</td></tr> <tr><td>4</td><td>stop bit</td><td>1</td><td>2</td></tr> <tr><td>5</td><td>sum check</td><td>N</td><td>Y</td></tr> <tr><td>6</td><td>RUN read-in</td><td>forbid</td><td>allow</td></tr> <tr><td>7</td><td>change</td><td>forbid</td><td>allow</td></tr> </tbody> </table> </div> </div>	bps	value	4800	04H	9600	05H	19200	07H	38400	09H	57600	0AH	1E+05	0BH	Bit	content	OFF	ON	0	Motion Setting	inching	cont	1	data bit	7	8	2	parity check bit	N	Y	3	parity check	odd	even	4	stop bit	1	2	5	sum check	N	Y	6	RUN read-in	forbid	allow	7	change	forbid	allow	0BEEH 115Kbps 8 bit 1 bit even
bps	value																																																			
4800	04H																																																			
9600	05H																																																			
19200	07H																																																			
38400	09H																																																			
57600	0AH																																																			
1E+05	0BH																																																			
Bit	content	OFF	ON																																																	
0	Motion Setting	inching	cont																																																	
1	data bit	7	8																																																	
2	parity check bit	N	Y																																																	
3	parity check	odd	even																																																	
4	stop bit	1	2																																																	
5	sum check	N	Y																																																	
6	RUN read-in	forbid	allow																																																	
7	change	forbid	allow																																																	
Switch2	CH1:communication protocol	MC protocol type5 binary	0005H																																																	
Switch3	CH2:transmission rate, transmission setting (the same as switch 1)		0BEEH																																																	
Switch4	CH2:communication protocol	MC protocol type5 binary	0005H																																																	
Switch5	Station No. setting	0~31	0000H																																																	

Supported Device

Fx1s

Device	Bit Address	Word Address	Format	Notes
Input Relay	X00-17	-----	OO	
Output Relay	Y00-15	-----	OO	
Auxiliary Relay	M000-511	-----	DDD	
Timer Relay	T00-63	-----	DD	
Counter Relay	C00-31	-----	DD	
Data Register Relay	D000.0-255.F	-----	DDD.H	
Status Relay	S000-127	-----	DDD	
Timer	-----	T00-63	DD	
Counter	-----	C00-31	DD	
Data register	-----	D000-255	DDD	
Special Data Register	-----	SD8000-8255	DDDD	
Counter Memory (DWord)	-----	C_dword235-255	DDD	

Fx2n

Device	Bit Address	Word Address	Format	Notes
Input Relay	X000-377	-----	OOO	
Output Relay	Y000-377	-----	OOO	
Auxiliary Relay	M0000-3071	-----	DDDD	
Timer Relay	T000-255	-----	DDD	
Counter Relay	C000-199	-----	DDD	
Special Auxiliary Relay	SM8000-8255	-----	DDDD	
Status Relay	S000-999	-----	DDD	
Timer	-----	T000-255	DDD	
Counter	-----	C000-199	DDD	
Data register	-----	D0000-7999	DDDD	
Special Data Register	-----	SD8000-8255	DDDD	
Counter Memory (DWord)	-----	C_dword200-255	DDD	

FX2N-10GM/20GM

Device	Bit Address	Word Address	Format	Notes
Input Relay	X 00-67	-----	OO	
Output Relay	Y 00-67	-----	OO	
Auxiliary Relay	M 000-511	-----	DDD	
Special Auxiliary Relay	SM9000-9175	-----	DDDD	
Data register	-----	D 000-3999	DDDD	

Special Data Register	-----	SD 9000-9599	DDDD	
	-----	FD 4000-6999	DDDD	

Note: bit devices don't support batch, but word device can.

Fx3u

Device	Bit Address	Word Address	Format	Notes
Input Relay	X000-377	-----	OOO	
Output Relay	Y000-377	-----	OOO	
Timer Relay	T000-511	-----	DDD	
Counter Relay	C000-199	-----	DDD	
Data Register Relay	D0000-7999	-----	DDDD	
Status Relay	S0000-4095	-----	DDDD	
Internal relay	M0000-7679	-----	DDDD	
Special internal relay	SM8000-8511	-----	DDDD	
Timer	-----	T000-511	DDD	
Counter	-----	C000-199	DDD	
Data register	-----	D0000-7999	DDDD	
Special Data Register	-----	SD8000-8511	DDDD	
Counter Memory (D Word)	-----	C_dword200-255	DDD	

Q00jCPU

Device	Bit Address	Word Address	Format	Notes
Counter coil	CC0-1023	-----	DDDD	
Counter contact	CS0-1023	-----	DDDD	
Timer coil	TC0-2047	-----	DDDD	
Timer contact	TS0-2047	-----	DDDD	
Special link Relay	SB000-7FF	-----	HHH	
Link Relay	B0000-1FFF	-----	HHHH	
Status Relay	S0000-8191	-----	DDDD	
Edge Relay	V0000-2047	-----	DDDD	
Annunciator	F0000-2047	-----	DDDD	
Latch relay	L0000-8191	-----	DDDD	
Special internal Relay	SM0000-2047	-----	DDDD	
Internal Relay	M0000-8191	-----	DDDD	
Output Relay	Y0000-1FFF	-----	HHHH	
Input Relay	X0000-1FFF	-----	HHHH	
File register	-----	R000-7FF	HHH	
Special Link register		SW0-3FF	HHH	

Link register	-----	W000-7FF	HHH	
Special data register	-----	SD0-2047	DDDD	
Data register	-----	D0-12287	DDDDD	
Counter	-----	CN0-1023	DDDD	
Retentive timer value	-----	SN0-2047	DDDD	
Timer	-----	TN0-2047	DDDD	

Q00CPU / Q01CPU / Q02HCPU / Q06HCPU / Q12HCPU / Q25HCPU

Device	Bit Address	Word Address	Format	Notes
Special Link Relay	SB00000-32767	-----	HHHH	
Link Relay	B00000-32767	-----	HHHH	
Edge Relay	V00000-32767	-----	DDDDD	
Annunciator Relay	F00000-32767	-----	DDDDD	
Latch Relay	L00000-32767	-----	DDDDD	
Special Internal Relay	SM0000-2047	-----	DDDD	
Internal Relay	M00000-32767	-----	DDDDD	
Output Relay	Y0000-8191	-----	HHHH	
Input Relay	X0000-8191	-----	HHHH	
Link register	-----	W00000-10527	HHHHH	
Timer (Current Value)	-----	TN00000-23087	DDDDD	
Counter (Current Value)	-----	CN00000-23087	DDDDD	
File register (Normal)	-----	R00000-32767	DDDDD	
Special Link register	-----	SW0000-2047	HHHH	
File register	-----	ZR00000-65535	DDDDD	
Data register	-----	D00000-25983	DDDDD	
Special data register	-----	SD0000-2047	DDDD	

Q02CPU

Device	Bit Address	Word Address	Format	Notes
Special Link Relay	SB000-7FF	-----	HHH	
Link Relay	B0000-1FFF	-----	HHHH	
Edge Relay	V0000-2047	-----	DDDD	
Annunciator Relay	F0000-2047	-----	DDDD	
Latch Relay	L0000-8191	-----	DDDD	
Special Internal Relay	SM0000-2047	-----	DDDD	
Internal Relay	M0000-8191	-----	DDDD	

Output Relay	Y0000-1FFF	-----	HHHH	
Input Relay	X0000-1FFF	-----	HHHH	
Link register	-----	W0000-1FFF	HHHH	
Timer (Current Value)	-----	TN0000-2047	DDDD	
Counter (Current Value)	-----	CN0000-1023	DDDD	
File register (Normal)	-----	R00000-32767	DDDDD	
Special Link register	-----	SW000-7FF	HHH	
File register	-----	D00000-12287	DDDDD	
Data register	-----	SD0000-2047	DDDD	

Cable Diagram

FX series RS232

CPU port communication

FX series programming cable using as communication cable.

communication module RS232BD communication cable

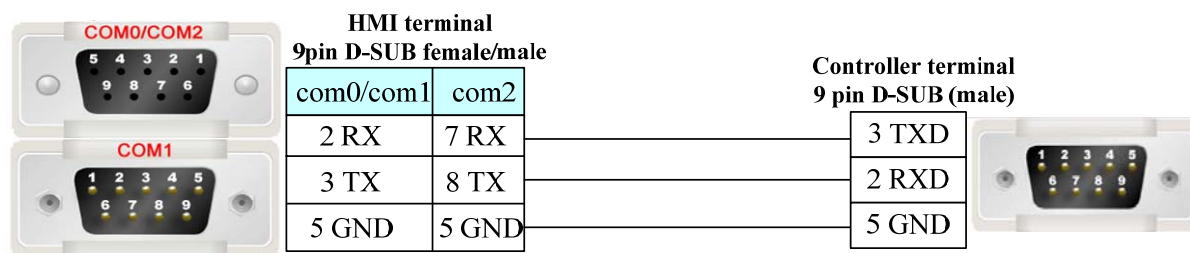

FX series RS422 cable

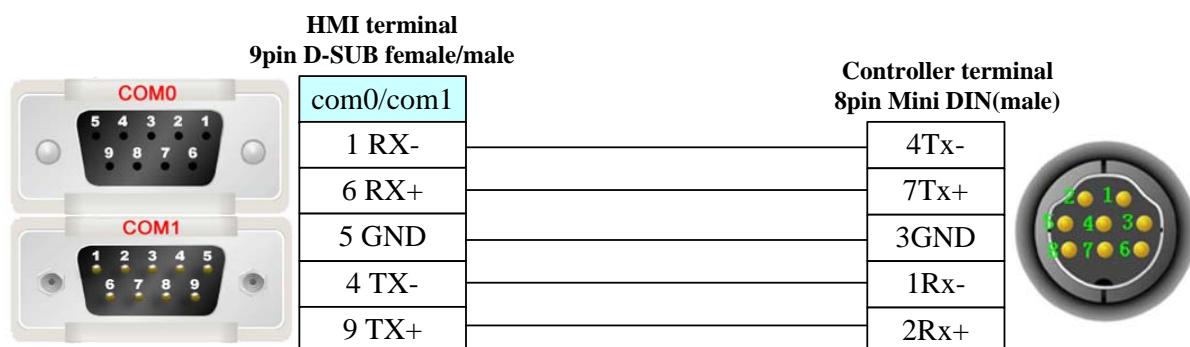

Q series RS232 cable

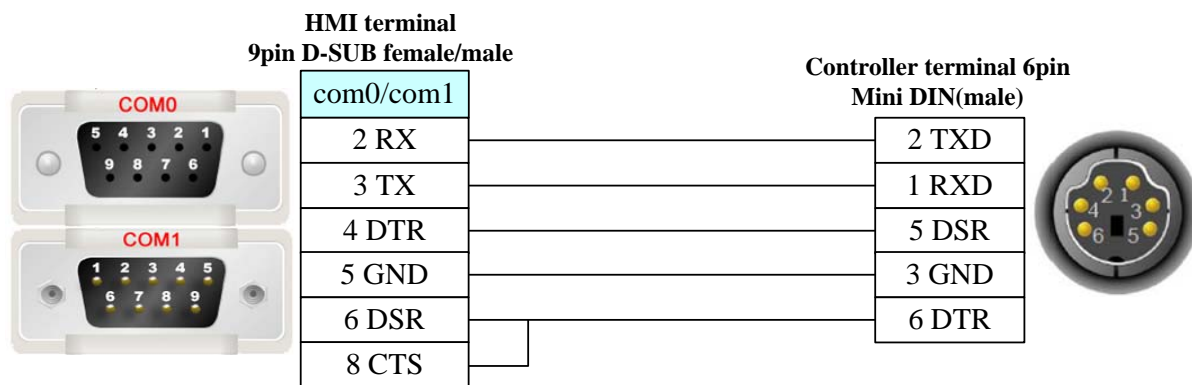

FX\Q series RS422 cable (422 communication module)

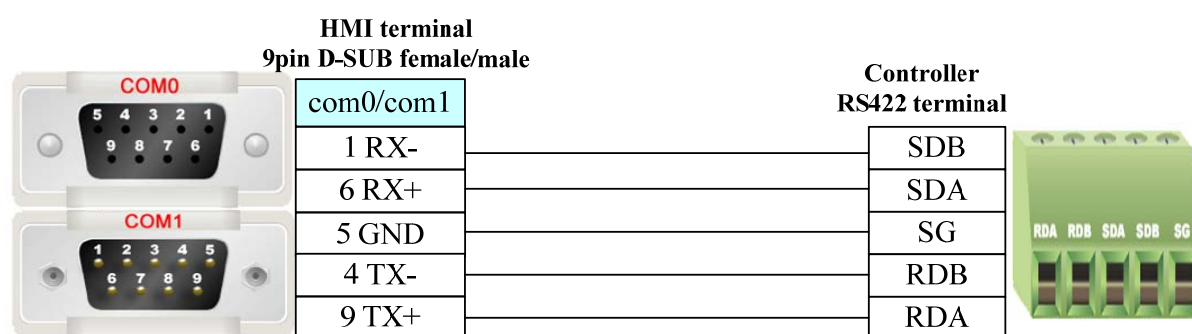

Mks controller

Serial Communication

Series	CPU	Link Module	Driver
BY125	BY125	RS232 on the CPU unit	MKS

System configuration

Series	CPU	Link Module	COMM Type	Parameter	Cable
BY125	BY125	RS232 on the CPU unit	RS232	Setting	Your owner cable

Communication Setting

Default communication: 9600, 7, even, 1; station: 11

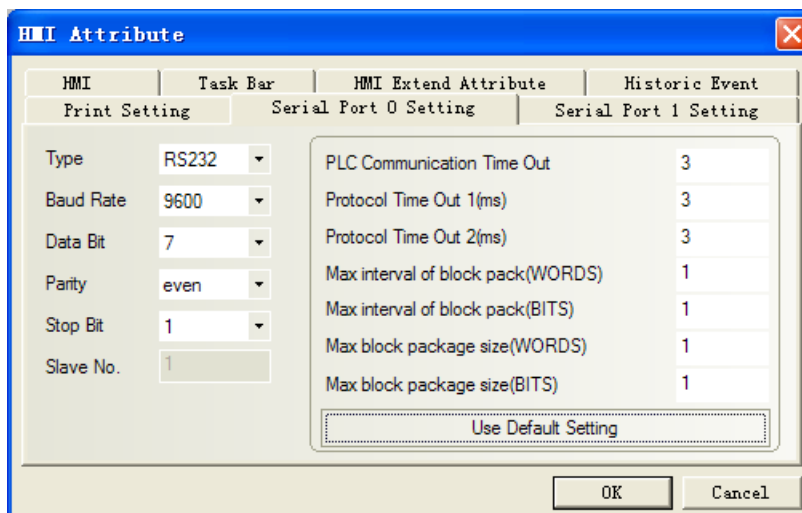

Supported Device

Device	Bit Address	Word Address	Format	Notes
Relay	CB 00-FF	-----	HH	
Register	-----	CD00-FF	HH	
External Register	-----	ERCD 0000.00-FFFF.FF	HHHH.HH	

Note:

- 1) ERCD is Extended register, the four position before radix point are C1,C2,C3,C4.The two positions after radix point are S1, S2.
- 2) Parameter code corresponding with CD are C1,C2;
- 3) Parameter code corresponding with CB set to "1";Eg:"Bit State Setting" part, addr type CB67, set the state to "1".

Cable Diagram

Mks controller RS232 communication cable

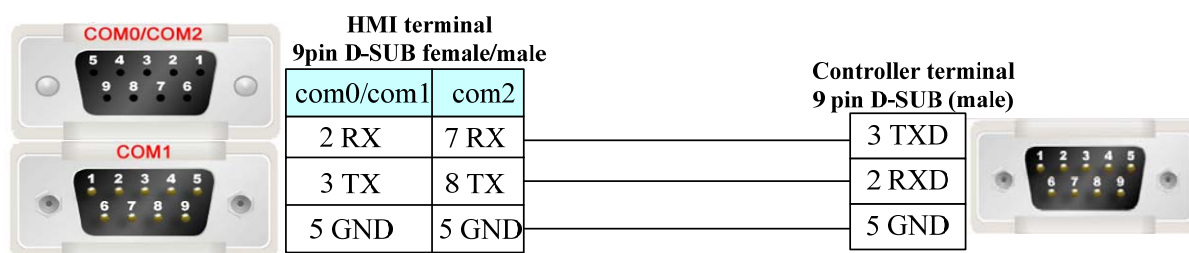

ModBus

Serial Communication

Series	CPU	Link Module	SIO type	Driver
--------	-----	-------------	----------	--------

Modbus RTU	MODBUS Compatible External Device	RS232 on the CPU unit		Modbus RTU
Modbus RTU Extend		RS232 on the CPU unit		Modbus RTU Extend
Modbus ASCII		RS232 on the CPU unit		Modbus ASCII
Modbus TCP			Ethernet	Modbus TCP
Modbus TCP Slave			Ethernet	Modbus TCP Slave
Modbus UDP			Ethernet	Modbus UDP
Modbus UDP Slave			Ethernet	Modbus UDP Slave

System configuration

Series	CPU	Link Module	COMM Type	Parameter	Cable
Modbus RTU	MODBUS Compatible External Device	RS232 on the CPU unit	RS232	Setting	Your owner cable
Modbus RTU Extend		RS232 on the CPU unit	RS232	Setting	Your owner cable
Modbus ASCII		RS232 on the CPU unit	RS232	Setting	Your owner cable
Modbus TCP			Ethernet	Connection Configuration	
Modbus TCP Slave			Ethernet		
Modbus UDP			Ethernet	Connection Configuration	
Modbus UDP Slave			Ethernet		

Communication Setting

Modbus RTU RS232 communication:9600, 8, even, 1; station: 1

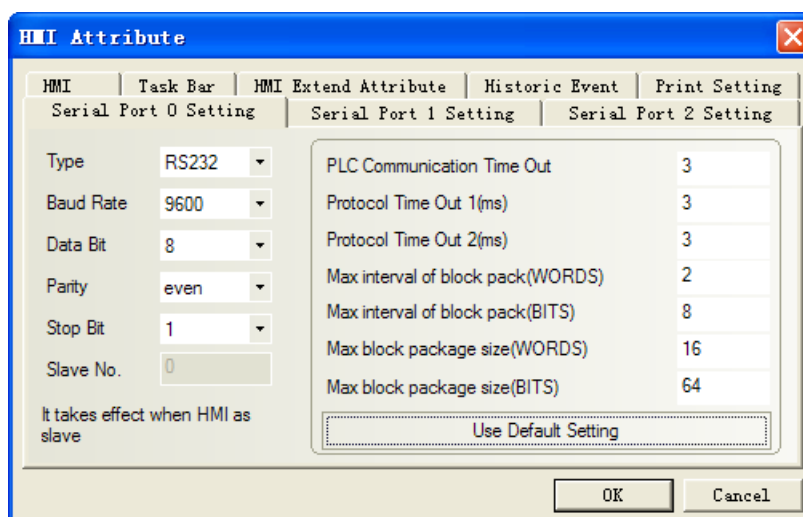

Modbus RTU Extend RS232 communication : 9600, 8, even, 1; station: 1

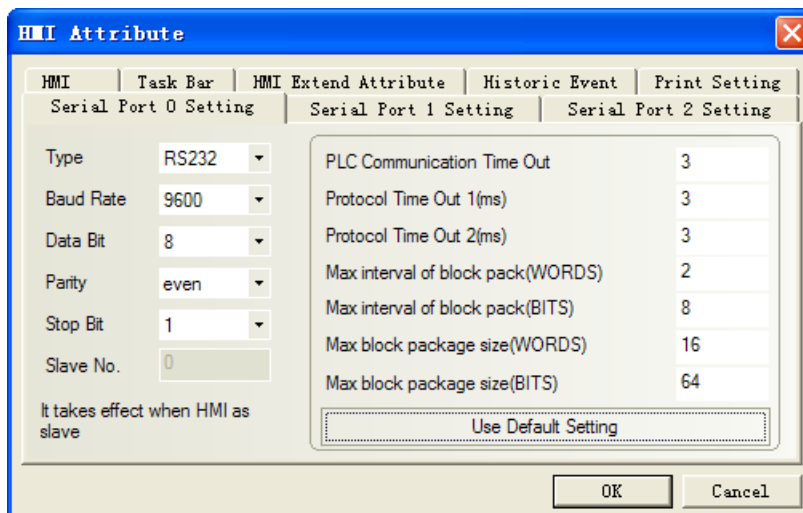

MODBUS ASCII RS232 communication: 9600, 8, even, 1; station: 1

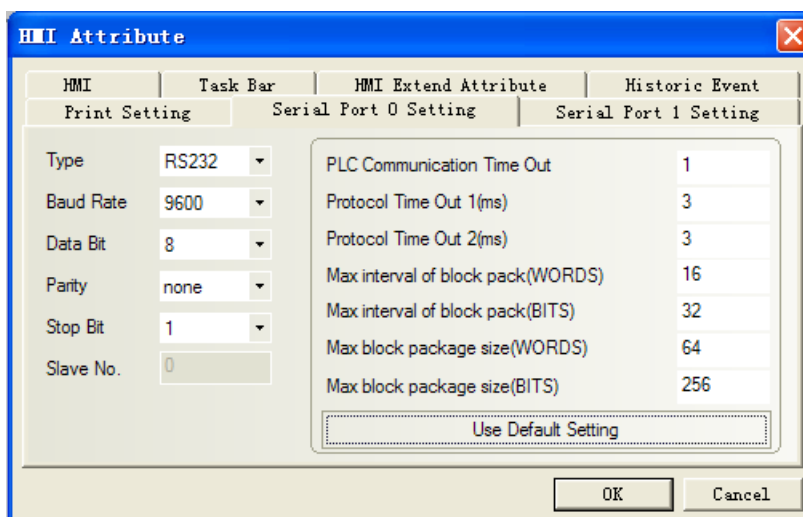

Modbus UDP network configuration

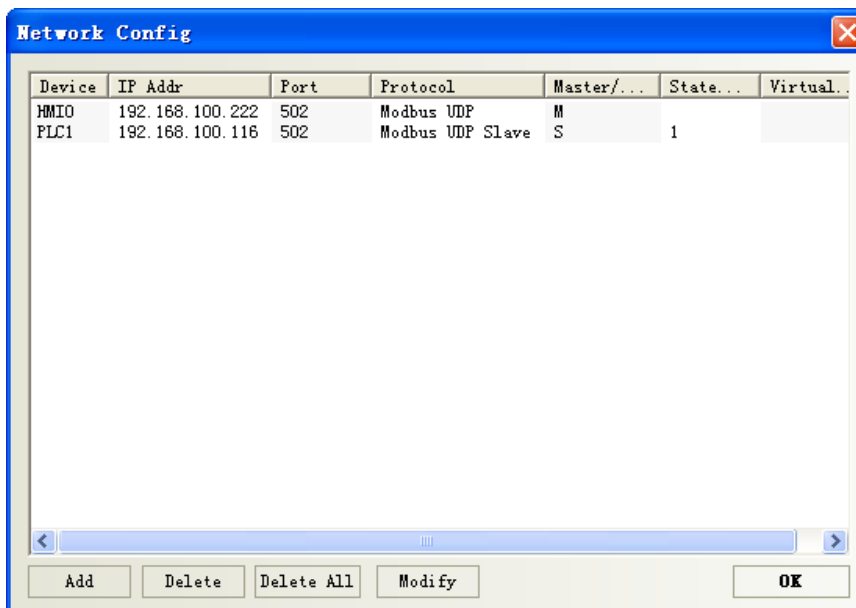

Supported Device

Modbus RTU

Device	Bit Address	Word Address	Format	Notes
Output Relay	0X1-65535	-----	DDDDD	
Input Relay (read only)	1X1-65535	-----	DDDDD	
Input Register (read only)	-----	3X1-65535	DDDDD	
Output Register	-----	4X1-65535	DDDDD	

Modbus RTU Extend

Device	Bit Address	Word Address	Format	Notes
Output Relay	0X1-65535	-----	DDDDD	
Input Relay (read only)	1X1-65535	-----	DDDDD	
Input Relay (read only)	3X_bit1-65535	-----	DDDDD	
Output Relay	4X_bit1-65535	-----	DDDDD	
Input Register (read only)	-----	3X1-65535	DDDDD	
Output Register	-----	4X1-65535	DDDDD	
4x double word swap	-----	5X1-65535	DDDDD	
4x single word write	-----	6X1-65535	DDDDD	

Modbus ASCII

Device	Bit Address	Word Address	Format	Notes
Output Relay	0X1-65535	-----	DDDDD	
Input Relay (read only)	1X1-65535	-----	DDDDD	
Input Register (read only)	-----	3X1-65535	DDDDD	
Output Register	-----	4X1-65535	DDDDD	

Modbus TCP Slave

Device	Bit Address	Word Address	Format	Notes
Output Relay	0X1-65535	-----	DDDDD	
Input Relay (read only)	1X1-65535	-----	DDDDD	
Input Register (read only)	-----	3X1-65535	DDDDD	
Output Register	-----	4X1-65535	DDDDD	

Modbus UDP Slave

Device	Bit Address	Word Address	Format	Notes
Output Relay	0X1-65535	-----	DDDDD	
Input Relay (read only)	1X1-65535	-----	DDDDD	
Input Register (read only)	-----	3X1-65535	DDDDD	
Output Register	-----	4X1-65535	DDDDD	

Cable Diagram

RS232 communication cable

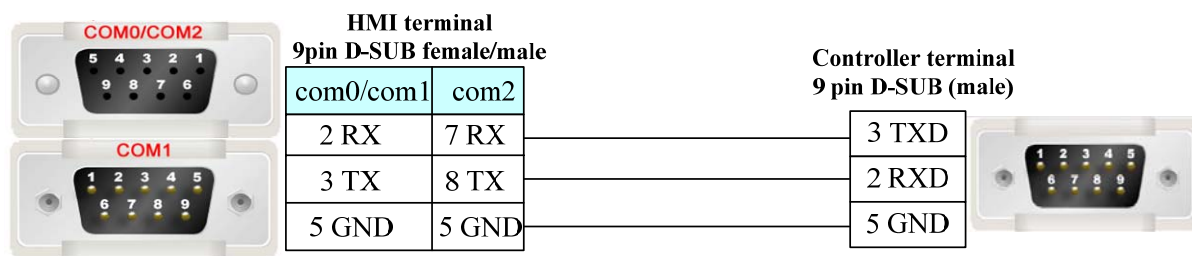

Ethernet communication cable

Cross-connection or crossover network cable can be used as communication cable via the hub.

a. Cross-connection cable:

HMI Ethernet terminal RJ45

Controller terminal RJ45

1 TX+ (orange,white)	3 RX+ (green,white)
2 TX- (orange)	6 RX- (green)
3 RX+ (green,white)	1 TX+ (orange,white)
4 BD4+ (blue)	4 BD4+ (blue)
5 BD4- (blue,white)	5 BD4- (blue,white)
6 RX- (green)	2 TX- (orange)
7 BD3+ (brown,white)	7 BD3 (brown,white)
8 BD3- (brown)	8 BD3- (brown)

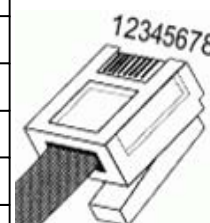

b. crossover network cable:

HMI Ethernet terminal RJ45

Ethernet Hub or Switch RJ45

1 TX+ (orange,white)	1 RX+ (orange,white)
2 TX- (orange)	2 RX- (orange)
3 RX+ (green,white)	3 TX+ (green,white)
4 BD4+ (blue)	4 BD4+ (blue)
5 BD4- (blue,white)	5 BD4- (blue,white)
6 RX- (green)	6 TX- (green)
7 BD3+ (brown,white)	7 BD3 (brown,white)
8 BD3- (brown)	8 BD3- (brown)

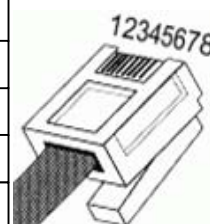

OE MAX

Serial Communication

Series	CPU	Link Module	Driver
NX7	NX7	RS232 on the CPU unit	OE MAX NX7

System configuration

Series	CPU	Link Module	COMM Type	Parameter	Cable
NX7	NX7	RS232 on the CPU unit	RS232	Setting	Your owner cable

Communication Setting

Default communication: 19200, 8, none, 1; station: 1

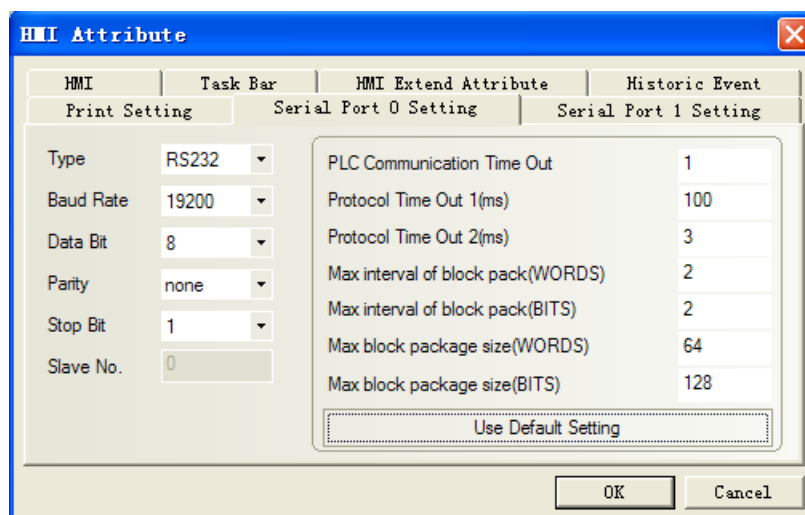

Supported Device

Device	Bit Address	Word Address	Format	Notes
Input/Output Relay	R 0.0–127.15	-----	DDD.DD	
General Relay	L 0.0–63.15	-----	DD.DD	
General Relay	M 0.0–127.15	-----	DDD.DD	
Keep Relay	K 0.0–127.15	-----	DDD.DD	
Timer Relay	TC 0–255	-----	DDD	
Special Relay	F 0.0–15.15	-----	DD.DD	
Internal HSC	-----	R_word 0-127	DDD	
General Register	-----	L_word 0-63	DD	
General Register	-----	M_word 0-127	DDD	
Keep Register	-----	K_word 0-127	DDD	
General Register	-----	F_word 0-15	DD	
Timer/Counter Register	-----	SV_word 0-255	DDD	
Timer/Counter Register	-----	PV_word 0-255	DDD	
General Register	-----	W_word 0-2047	DDDD	
Special Register	-----	SR_word 0-511	DDD	
Internal HSC	-----	R_Dword 0-127	DDD	

General Register	-----	L_Dword 0-63	DD	
General Register	-----	M_Dword 0-127	DDD	
Keep Register	-----	K_Dword 0-127	DDD	
Special Register	-----	F_Dword 0-15	DD	
Timer/Counter Register	-----	SV_Dword 0-255	DDD	
Timer/Counter Register	-----	PV_Dword 0-255	DDD	
General Register	-----	W_Dword 0-2047	DDDD	
Special Register	-----	SR_Dword 0-511	DDD	

Cable Diagram

Oemax RS232 communication cable

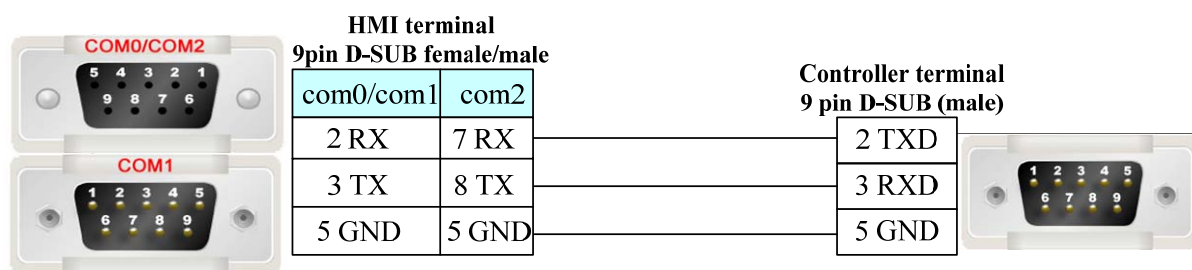

Omron Corporation

Serial Communication

Series	CPU	Link Module	Driver	
SYSMAC C	CP1H	CP1W-CIF01	Omron C Series Host Link	
	CP1L	CP1W-CIF11		
	CP1E		Omron CP1H_CP1L	
	C200H	C200H	C200H-LK202 C120-LK201-V1	Omron C Series Host Link
		C200HS	C200H-LK201 C200H-LK202 C120-LK201-V1	
	C500	C500	Link I/F on the CPU unit	
		C500F	Peripheral port on the CPU unit	
C1000H		C120-LK201-V1		
C2000		C120-LK202-V1		
C2000H		C500-LK201-V1 C500-LK203		
C1000HF	C500-LK201-V1 C500-LK203			

	C20H/28H/40H	Link I/F on the CPU unit		
	C20PF/28PF	C120-LK201-V1		
	C40PF/60PF	C120-LK202-V1		
	C120	C120-LK201-V1		
	C120F	C120-LK202-V1		
	CQM1-CPU11	Peripheral port on the CPU unit		
	CQM1-CPU21	RS232C port on the CPU unit		
	CQM1-CPU41	Peripheral port on the CPU unit		
	CQM1-CPU42			
	CQM1-CPU43			
	CQM1-CPU44			
	CQM1-CPU41-V1			
	CQM1-CPU42-V1			
	CQM1-CPU43-V1			
	CQM1-CPU44-V1			
	CPM2C	Peripheral port on the CPU unit		
		Peripheral port on the CPM2C-CIF01		
		RS232C port on the CPM2C-CIF01		
		RS232C port on the CPM2C-CIF11		
		Terminal block on the CPM2C-CIF11		
	CQM1H-CPU11	Peripheral port on the CPU unit		
	CQM1H-CPU21	RS232 on the CPU unit		
	CQM1H-CPU51	Peripheral port on the CPU unit		
		RS232 on the CPU unit		
		RS232C port on the CQM1H-SCB41		
		RS422A/485 port on the CQM1H-SCB41		
	CPM1	RS232 on the CPU unit	Omron C Series Host Link	
	CPM1A			
	CPM1A-V1			
	CPM2AH			Omron CPM1AH _CPM2AH
SYSMAC CJ	CJ1G-CPU45	RS232 on the CPU unit		
	CJ1G-CPU44	Peripheral port on the CPU unit		
	CJ1G-CPU45H	Peripheral port on the CPU unit		
	CJ1G-CPU44H			
	CJ1G-CPU43H			
	CJ1G-CPU42H			
	CJ1M-CPU23			
	CJ1M-CPU22			
	CJ1M-CPU21			
	CJ1M-CPU13			
	CJ1M-CPU12			
	CJ1M-CPU11			
	CJ1H-CPU66H			
	CJ1H-CPU65H			
				Omron CJ_CS Series Host Link

SYSMAC CS1	CS1G-CPU45	RS232 on the CPU unit	Omron CJ_CS Series Host Link
	CS1G-CPU44	Peripheral port on the CPU unit	
	CS1G-CPU43		
	CS1G-CPU42		
	CS1G-CPU45H		
	CS1G-CPU44H		
	CS1G-CPU43H		
	CS1G-CPU42H		
	CS1G-CPU45-V1		
	CS1G-CPU44-V1		
	CS1G-CPU43-V1		
	CS1G-CPU42-V1		
	CS1H-CPU67		
	CS1H-CPU66		
	CS1H-CPU65		
	CS1H-CPU64		
	CS1H-CPU63		
	CS1H-CPU67H		
	CS1H-CPU66H		
	CS1H-CPU65H		
	CS1H-CPU64H		
	CS1H-CPU63H		
	CS1H-CPU67-V1		
	CS1H-CPU66-V1		
	CS1H-CPU65-V1		
	CS1H-CPU64-V1		
	CS1H-CPU63-V1		

Note: Don't live plug!!!

System configuration

Series	CPU	Link Module	COMM Type	Parameter	Cable
SYSMAC C	CP1H	CP1W-CIF01	RS232	Setting	Your owner cable
	CP1L CP1E	CP1W-CIF11	RS485-4	Setting	Your owner cable
	CPM2AH	RS232 on the CPU unit	RS232	Setting Setting	Your owner cable
SYSMAC CJ	CJ1G-CPU45 CJ1G-CPU44 CJ1G-CPU45H	RS232 on the CPU unit	RS232	Setting	Your owner cable

	CJ1G-CPU44H CJ1G-CPU43H CJ1G-CPU42H CJ1M-CPU23 CJ1M-CPU22 CJ1M-CPU21 CJ1M-CPU13 CJ1M-CPU12 CJ1M-CPU11 CJ1H-CPU66H CJ1H-CPU65H	Peripheral port on the CPU unit (Must set the switch DIP 4 to be on)	RS232	Setting	Your owner cable
SYSMAC CS	CS1G-CPU45 CS1G-CPU44 CS1G-CPU43 CS1G-CPU42 CS1G-CPU45H CS1G-CPU44H CS1G-CPU43H	RS232 on the CPU unit	RS232	Setting	Your owner cable
	CS1G-CPU42H CS1G-CPU45-V1 CS1G-CPU44-V1 CS1G-CPU43-V1 CS1G-CPU42-V1 CS1H-CPU67 CS1H-CPU66 CS1H-CPU65 CS1H-CPU64 CS1H-CPU63 CS1H-CPU67H CS1H-CPU66H CS1H-CPU65H CS1H-CPU64H CS1H-CPU63H CS1H-CPU67-V1 CS1H-CPU66-V1 CS1H-CPU65-V1 CS1H-CPU64-V1 CS1H-CPU63-V1	Peripheral port on the CPU unit (Must set the switch DIP 4 to be on)	RS232	Setting	Your owner cable

Communication Setting

OMRON CP1H_CP1L default communication: 9600, 7, even, 2; station: 0
[CP1W-CIF01 RS232 communication](#)

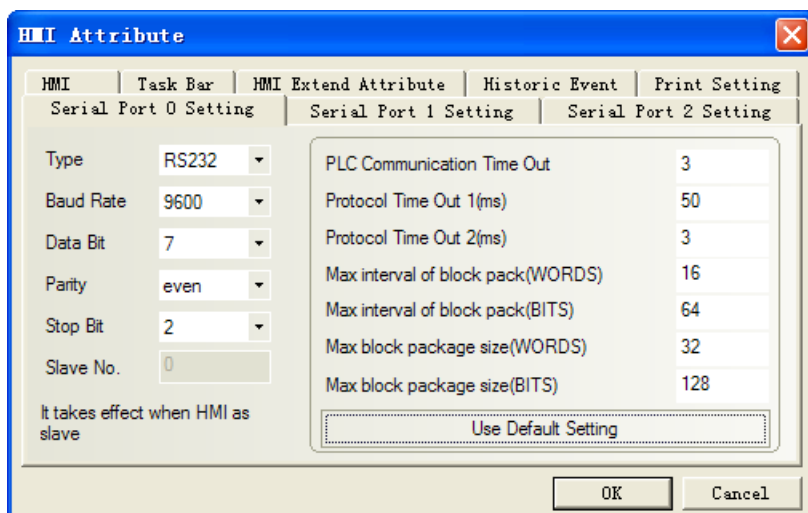

CPIW-CIF01 RS422 communication

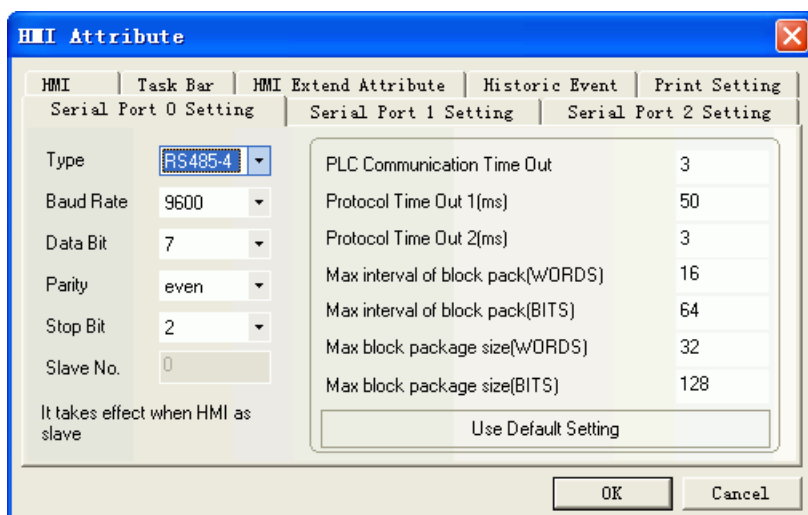

Note: cp1h switch DIP1—6 all set OFF.

NO.	Setup contents	default status
1	ON: write enable OFF: write disable	OFF
2	ON: program automatically transmit from card to PLC when power up OFF: program can't automatically transmit from card to PLC when power up	OFF
3	OFF: OFF(default)	OFF
4	ON: communication port1, Toolbus(default) OFF: Port 1 communications settings according to the PLC system CPU setting	OFF
5	ON: communication port2, Toolbus(default) OFF: Port 2 communications settings according to the PLC system CPU setting	OFF
6	ON: customer use (A395.12 = ON) OFF: customer use (A395.12 = OFF)	OFF

Omron C Series Host Link protocol default communication: 19200, 7, even, 2; station: 0
RS232 communication

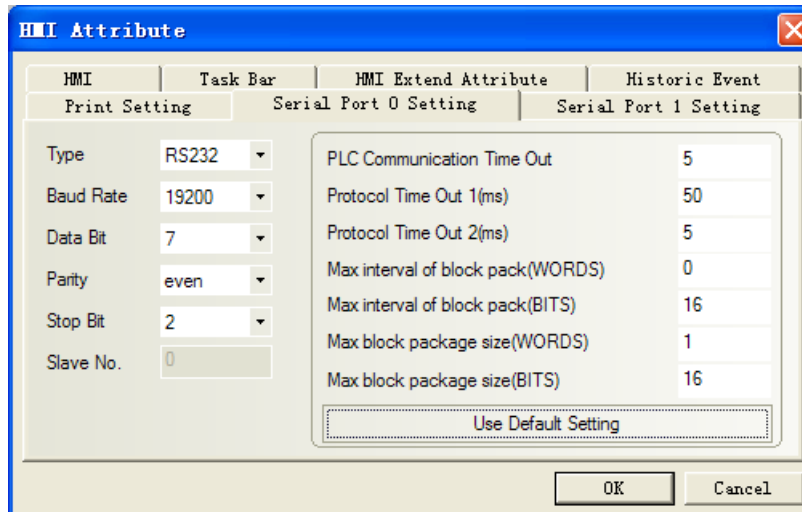

RS422 communication

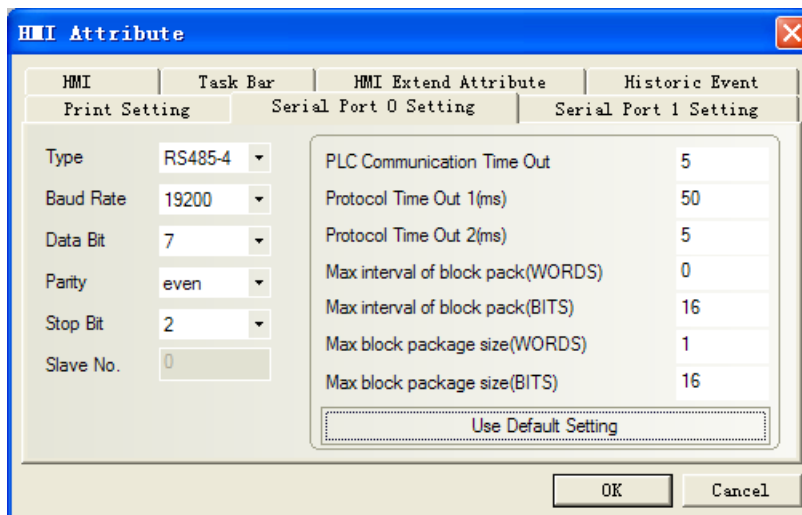

CPM1AH_CPM2AH protocol RS232 default communication: 9600, 7, even, 2; station: 0

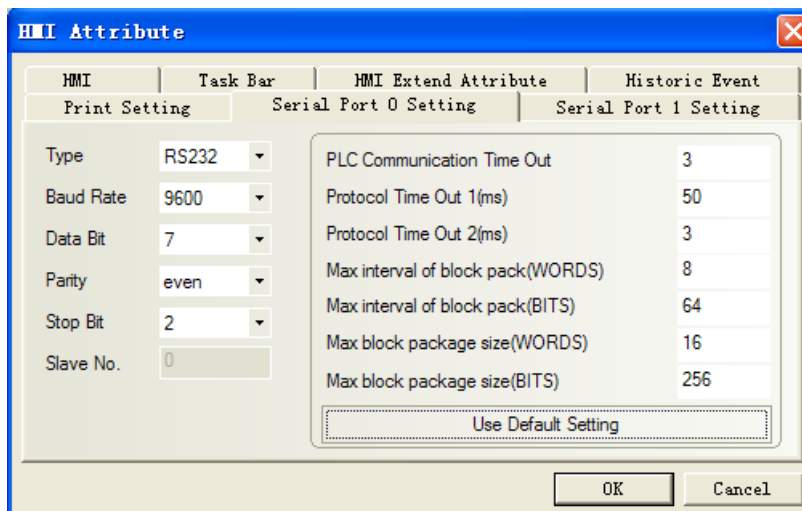

Note: Select custom communication parameters (non-standard communication parameters), the switch of plc must be OFF.

Omron CJ1M-CPU22 RS232 default communication: 9600, 7, even, 2; station: 0

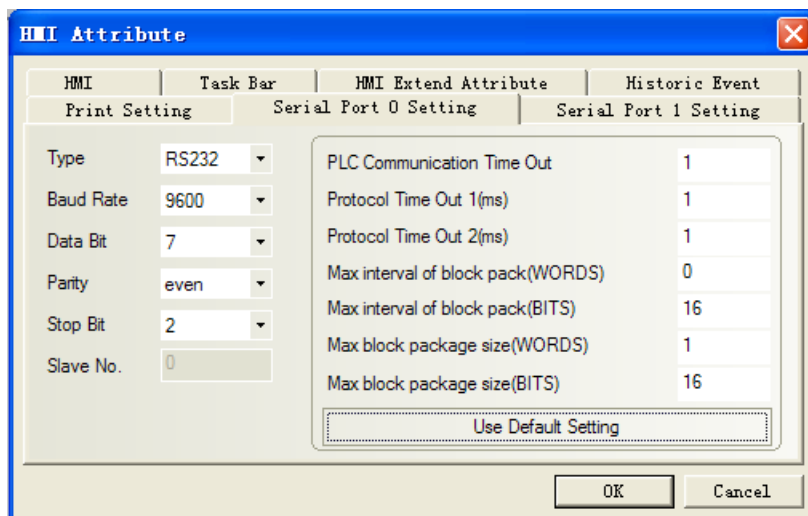

Note: 1. CJ1M switch DIP: sw1, sw2, sw3, sw5, sw8 must be off, but sw4, sw6, sw7 are optional.
2. CJ1M switches DIP 1—8 are OFF (default).

Omron CS series RS232 default communication: 9600, 7, even, 2; station: 0

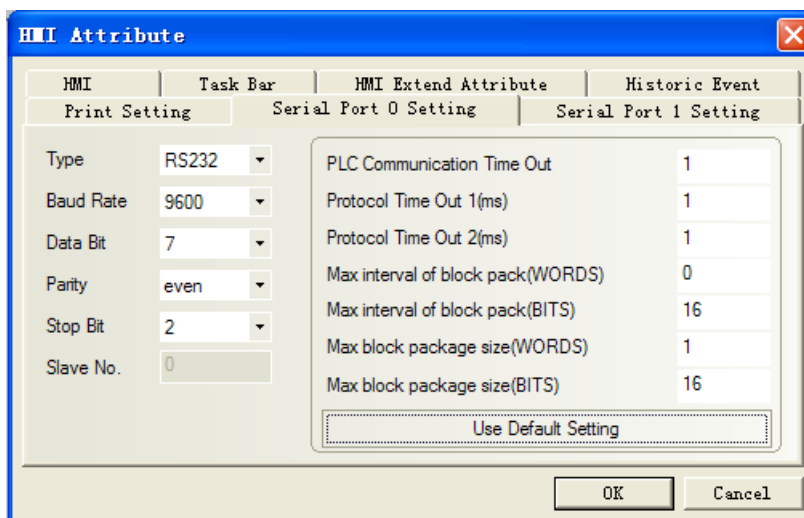

Supported Device

Omron SYSMAC C Series

Device	Bit Address	Word Address	Format	Notes
Latch Relay	HR00.00-99.15	-----	DD.DD	
Data Memory Relay	DM0000.00-6655.15	-----	DDDD.DD	
Data Link Relay	LR00.00-63.15	-----	DD.DD	
Auxiliary Memory Relay	AR00.00-959.15	-----	DD.DD	
Internal Auxiliary Relay	CIO_IR000.00-511.15	-----	DDD.DD	
Counter (Current Value)	-----	CNT000-511	DDD	
Timer (Current Value)	-----	TIM000-511	DDD	

Latch Register	-----	HR00-99	DD	
Data Memory Register	-----	DM0000-6655	DDDD	
Link Register	-----	LR00-63	DD	
Auxiliary Memory Register	-----	AR000-959	DDD	
Internal Auxiliary Register	-----	CIO_IR000-511	DDD	

OMRON CJ

Device	Bit Address	Word Address	Format	Notes
Channel I/O Relay	CIO0000.00-6143.15	-----	DDDD.DD	
Internal Auxiliary Relay	WR000.00-511.15	-----	DDD.DD	
Special Auxiliary Relay	AR000.00-959.15	-----	DDD.DD	
Latch Relay	HR000.00-511.15	-----	DDD.DD	
Timer Relay (Timer Up Flag)	TIM0000-4095	-----	DDDD	
Counter Relay(Counter Up Flag)	CNT0000-4095	-----	DDDD	
Data Memory	DM00000.00-32767.15	-----	DDDDD.DD	
Channel I/O Register	-----	CIO0000-6143	DDDD	
Internal Auxiliary Register	-----	WR000-511	DDD	
Special Auxiliary Register	-----	AR000-959	DDD	
Latch Register	-----	HR000-511	DDD	
Timer (current Value)	-----	TIM0000-4095	DDDD	
Counter (Current Value)	-----	CNT0000-4095	DDDD	
Data Memory Register	-----	DM00000-32767	DDDDD	
Index Register	-----	IR00-15	DD	
Data Register	-----	DR00-15	DD	

Cable Diagram

Omron RS232 on the CPU unit

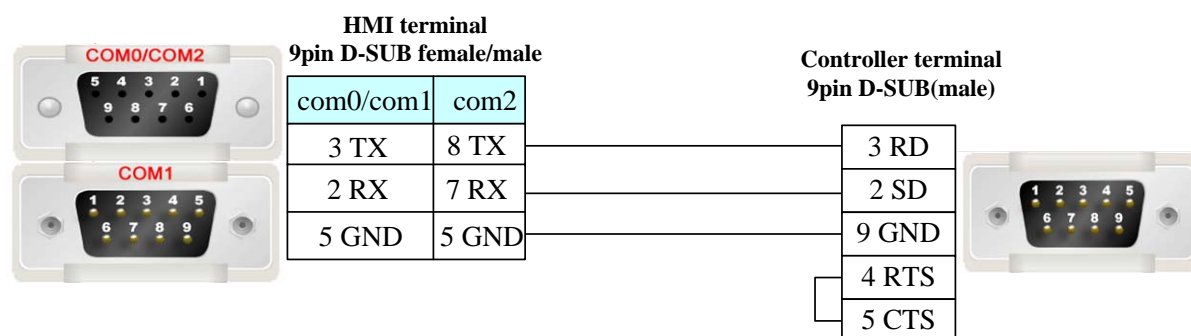

Omron CJ\CS series Peripheral port on the CPU unit

When connecting the peripheral port on the CPU by the conversion adapter, set DIP4 to on.

Omron CP1H RS422 communication cable

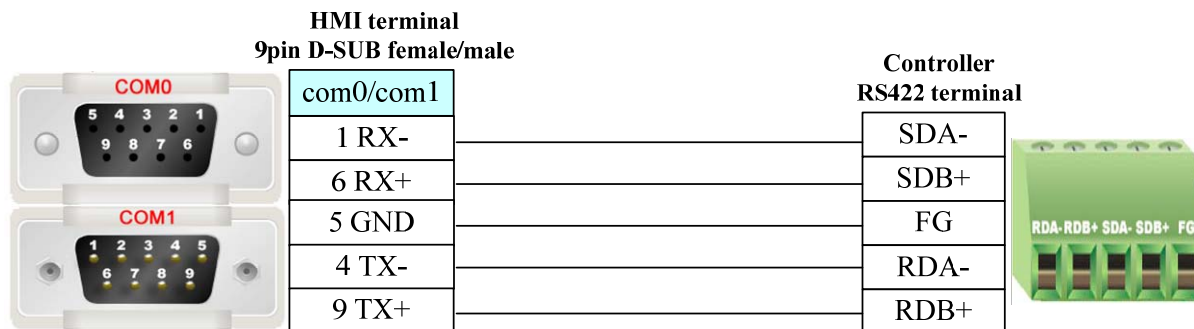

Note: When connecting by the 4-wire method, set DIP1~6 to off. (The dip on the back of option board)

Omron CP1H RS485 communication cable

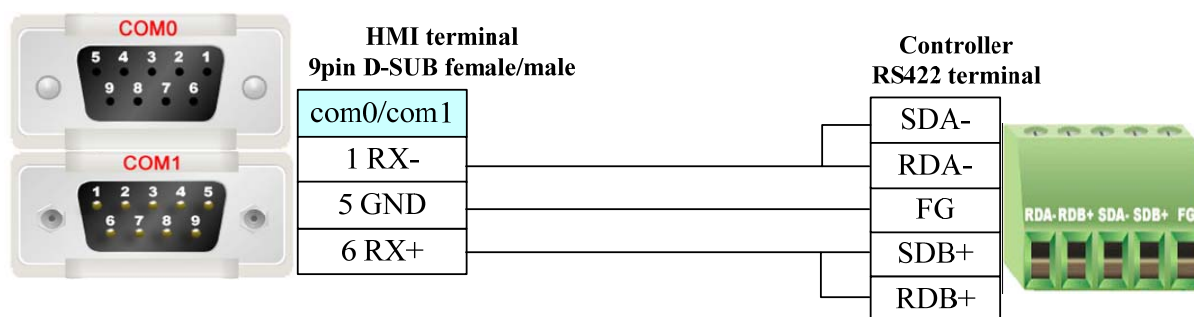

Note: When connecting by the 2-wire method, set DIP1 to off, DIP 2, 3, 5, 6 to on.

OMRON E5EZ-R3(Temperature Controller)

Serial Communication

Series	CPU	Link Module	Driver
OMRON E5EZ-R3	E5EZ-R3	RS485 on the CPU unit	OMRON E5EZ-R3

System configuration

Series	CPU	Link Module	COMM Type	Parameter	Cable
OMRON E5EZ-R3	OMRON E5EZ-R3	RS485 on the CPU unit	RS485-2	Setting	Your owner cable

Communication Setting

Default communication: 9600, 7, even, 2; station: 0

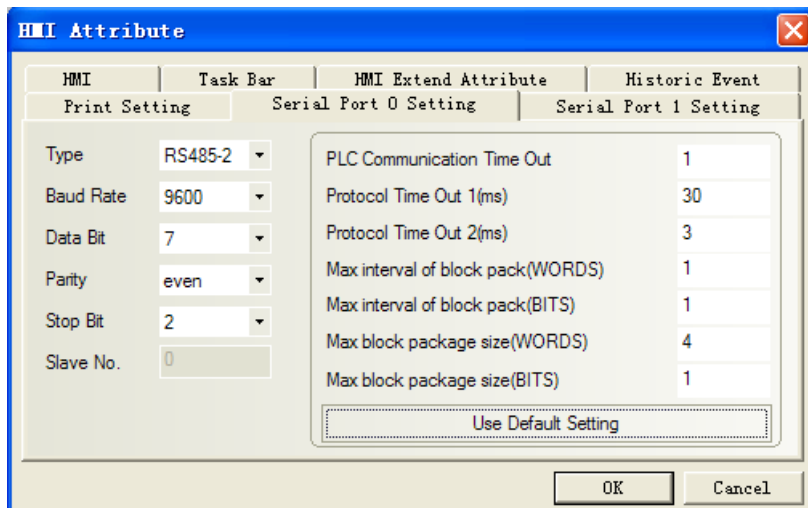

Supported Device

OMRON E5EZ-R3

Device	Bit Address	Word Address	Format	Notes
Variable	-----	0.0 — 0.A (C0 read only)	DDD.H H	Main addr indicates variable type 0(C0),1(C1),2(C3) subaddress indicates address of variable type
		1.0 — 1.2D (C1)		
		2.0 — 2.5B (C3)		
Action Command	-----	0-8	H	
State	0-31	-----	DD	Show the bit value of 0001 (state) in C0
Abnormal Input	0	-----	D	The 6th value of C0 0001(state) Abnormal Input

Action Command address and other informations

Addr	command	content	Notes
0	Communication write	00:OFF (disable)	Before writing data, "Communication write" command is "01" ON (enable)", otherwise it writes disable
		01:ON (enable)	
1	Run/Stop	00: Run	
		01: Stop	
2	Multi-segment SP	00: Setting value 0	Must set the value of variable(addr:3.1A) to 1(ON) for writing correctly, otherwise it can't write-in.
		01: Setting value 1	
		02: Setting value 2	
		03: Setting value 3	
3	AT execute/stop	00: stop	
		01: AT execute	
4	write-in mode	00: save	
		01: RAM	
5	RAM storage	00	
6	Soft reset	00	

7	Setting area1 shift	00	
8	Protection value shift	00	

Please refer to the communication protocol for details.

H indicates hexadecimal

Note:

- Make sure the setting value be the same as the plc's station No.
- Must be the same as the station No. of HMI
- Before writing data, "Communication write" command must is "01" ON (enable)", otherwise it writes disable

Cable Diagram

RS485-2 communication cable

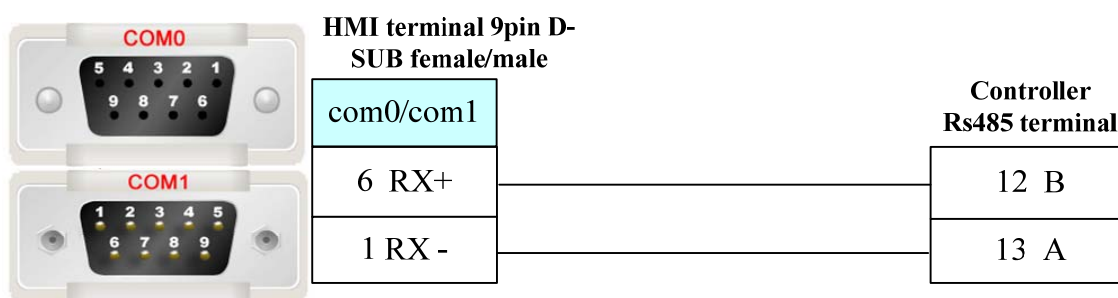

RS232 communication, need to use RS-232 to RS-422/485 converter

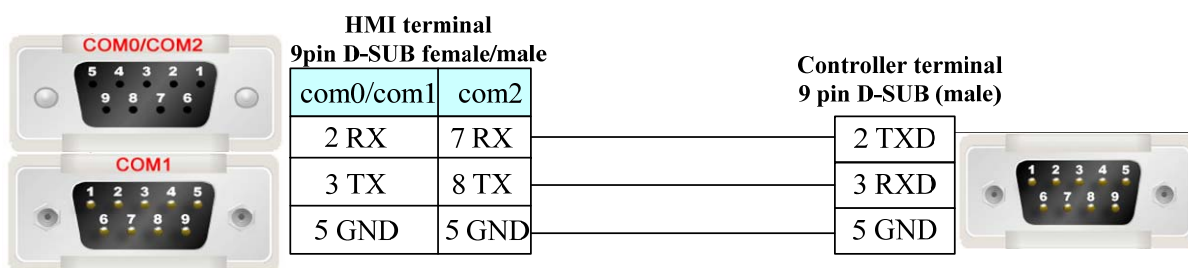

OPTO 22

Ethernet Communication (nonsupport Direct Online Simulation)

Series	CPU	Link Module	Driver
OPTO 22	SNAP-UP1-ADS	Ethernet	OPTO 22 Slave

System configuration

Series	CPU	Link Module	Connect Type	Parameter	Cable
OPTO 22	SNAP-UP1-ADS	Ethernet	Ethernet	Setting	Your owner cable

Communication Setting

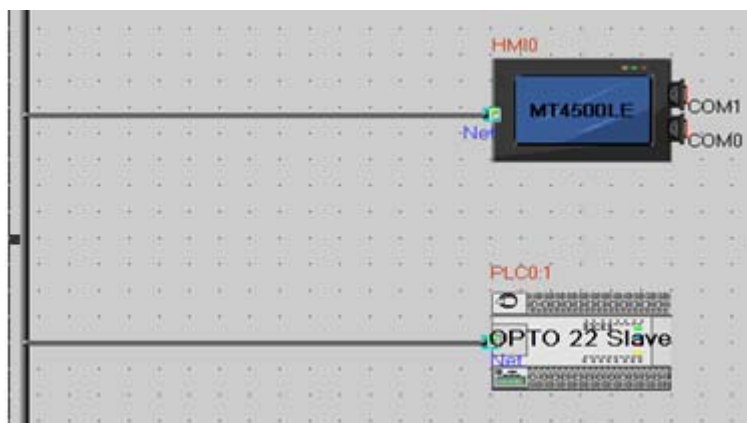

Network Configuration

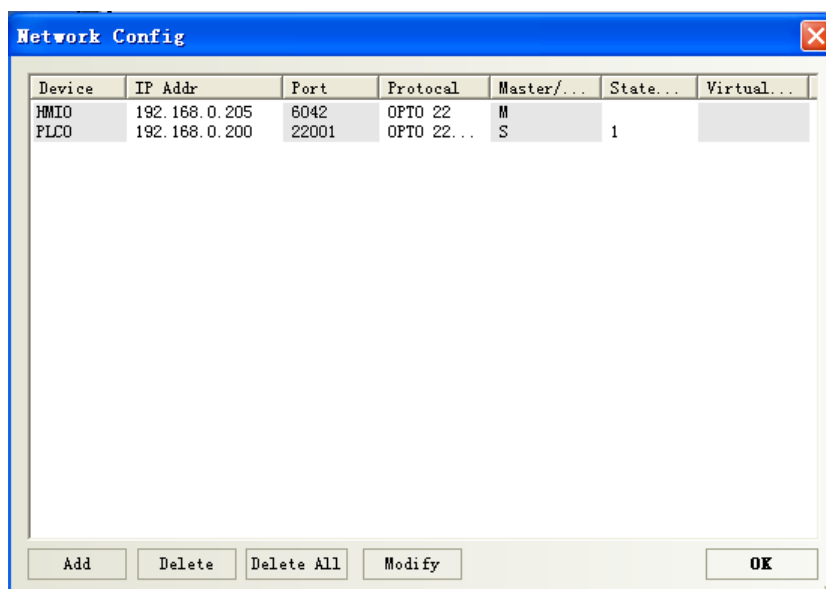

Supported Device

Device	Bit Address	Word Address	Format
Bit Table	B0-65535	—	DDDDD
Bit Table	BT0.000-65535.255	—	DDDDD.DDD
Integer 32	—	N32 0-65535	DDDDD
Float	—	FN0-65535	DDDDD
UP Timer	—	UTN0-65535	DDDDD
Down Timer	—	DTN0-65535	DDDDD
PID parameter	—	PIDSN0.00-32.06	DDDDD.DD
Integer 32 Table	—	NT0.000-65535.255	DDDDD.DDD
Float Table	—	FT0.000-65535.255	DDDDD.DDD

Editing Macro, please refer to the type table:

Register	Type	
N32	Double	
FN	Float	
DTN	Float	
UTN	Float	
PID	Input	Float
	SetPoint	Float
	Output	Float
	Gain	Float
	Tune I	Float
	Tune D	Float
	Mode	Double
IN	BIT	
QN	BIT	
PIN	Float	
PQN	Float	
NT	Double	
FT	Float	
B	BIT(the attribute of B is the same as N32 in the PLC software)	
BT	BIT(the attribute of BT is the same as NT in the PLC software)	

Note:

1、 The configuration in OPTO 22 software must be the same as the configuration in EV5000 software:

true: e.g.: define Float in the OPTO 22 software, F1

Select FN device in the EV5000 software, address: 1.

Communicate correctly

error: e.g.: define Float in the OPTO 22 software, F0001

Select FN device in the EV5000 software, address: 1.

Communicate error

2、 PIDSN correspondence

If it set up PID1 in the OPTO 22 software, it can show the values of Input, SetPoint, Output, Gain, Tune I, Tune D, and Mode.

In the Ev5000 software, PIDSN format DDDDD.DD, Address can be written in 1.**.(the main address in front of decimal point corresponding to the OPTO 22 of PID1 1 ,sub-addr refer to the table. the table as follows:

Sub Address (Example PID1, 1 is sub address)	Corresponding Value
1.00	Input
1.01	SetPoint
1.02	Output
1.03	Gain
1.04	Tune I
1.05	Tune D

1.06	Mode
------	------

Cable Diagram

Ethernet communication cable

Cross-connection or crossover network cable can be used as communication cable via the hub

a. Cross-connection cable

**HMI Ethernet terminal
RJ45**

1 TX+ (orange,white)
2 TX- (orange)
3 RX+ (green,white)
4 BD4+ (blue)
5 BD4- (blue,white)
6 RX- (green)
7 BD3+ (brown,white)
8 BD3- (brown)

**Controller terminal
RJ45**

3 RX+ (green,white)
6 RX- (green)
1 TX+ (orange,white)
4 BD4+ (blue)
5 BD4- (blue,white)
2 TX- (orange)
7 BD3 (brown,white)
8 BD3- (brown)

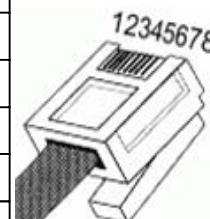

b. crossover network cable

**HMI Ethernet terminal
RJ45**

1 TX+ (orange,white)
2 TX- (orange)
3 RX+ (green,white)
4 BD4+ (blue)
5 BD4- (blue,white)
6 RX- (green)
7 BD3+ (brown,white)
8 BD3- (brown)

**Ethernet Hub or Switch
RJ45**

1 RX+ (orange,white)
2 RX- (orange)
3 TX+ (green,white)
4 BD4+ (blue)
5 BD4- (blue,white)
6 TX- (green)
7 BD3 (brown,white)
8 BD3- (brown)

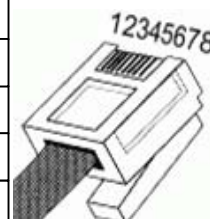

Parker Compax3 (Servo Controller)

Serial Communication

Series	CPU	Link Module	Driver
Parker Compax3	Parker Compax3	RS232 on CPU unit	Parker Compax3
		RS485 on CPU unit	

System configuration

Series	CPU	Link Module	COMM Type	Parameter	Cable
--------	-----	-------------	-----------	-----------	-------

Parker Compax3	Parker Compax3	RS232 on CPU unit	RS232	Setting	Your owner cable
		RS485 on CPU unit	RS485-2	Setting	Your owner cable

Communication Setting

HMI

RS232 default communication: 115200, 8, none, 1; station: no address

The screenshot shows the 'HMI Attribute' dialog box with the 'Serial Port 0 Setting' tab selected. The 'Type' is set to 'RS232', 'Baud Rate' is '115200', 'Data Bit' is '8', 'Parity' is 'none', 'Stop Bit' is '1', and 'Slave No.' is '1'. The 'PLC Communication Time Out' is '10', 'Protocol Time Out 1(ms)' is '50', 'Protocol Time Out 2(ms)' is '3', 'Max interval of block pack(WORDS)' is '1', 'Max interval of block pack(BITS)' is '1', 'Max block package size(WORDS)' is '1', and 'Max block package size(BITS)' is '1'. There is a 'Use Default Setting' button and 'OK' and 'Cancel' buttons at the bottom.

RS485-2 default communication: 9600, 8, none, 1; station: 1

The screenshot shows the 'HMI Attribute' dialog box with the 'Serial Port 1 Setting' tab selected. The 'Type' is set to 'RS485-2', 'Baud Rate' is '9600', 'Data Bit' is '8', 'Parity' is 'none', 'Stop Bit' is '1', and 'Slave No.' is '1'. The 'PLC Communication Time Out' is '10', 'Protocol Time Out 1(ms)' is '50', 'Protocol Time Out 2(ms)' is '3', 'Max interval of block pack(WORDS)' is '1', 'Max interval of block pack(BITS)' is '1', 'Max block package size(WORDS)' is '1', and 'Max block package size(BITS)' is '1'. There is a 'Use Default Setting' button and 'OK' and 'Cancel' buttons at the bottom.

Note: RS-485 Settings can be made in the C3 Servo Manager under "RS485 settings"

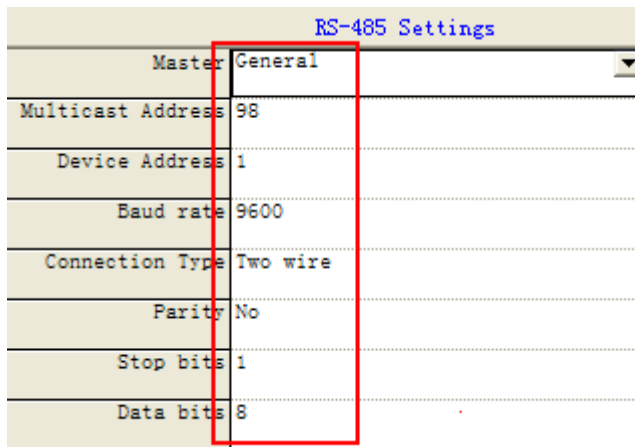

Supported Device

Device	Bit Address	Word Address	Format
	R_Bit 0.0-9999999.31	-----	DDDDDDDD.DD
	-----	R_Float 0.0-9999.511	DDDD.DDD
	-----	R_Int 0.0-9999.511	DDDD.DDD

Note: R_Bit device is the bit format of R_Int device. The address of R_Bit device is DDDDDDD.DD, the first seven position indicate the address of R_Int, the last two position indicate 32-bit

Cable Diagram

RS232

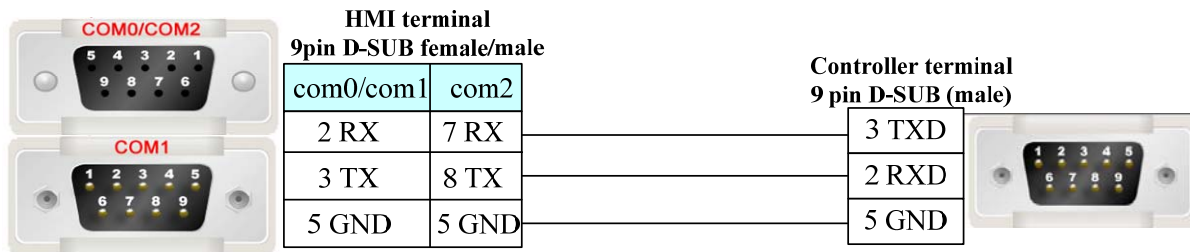

RS485

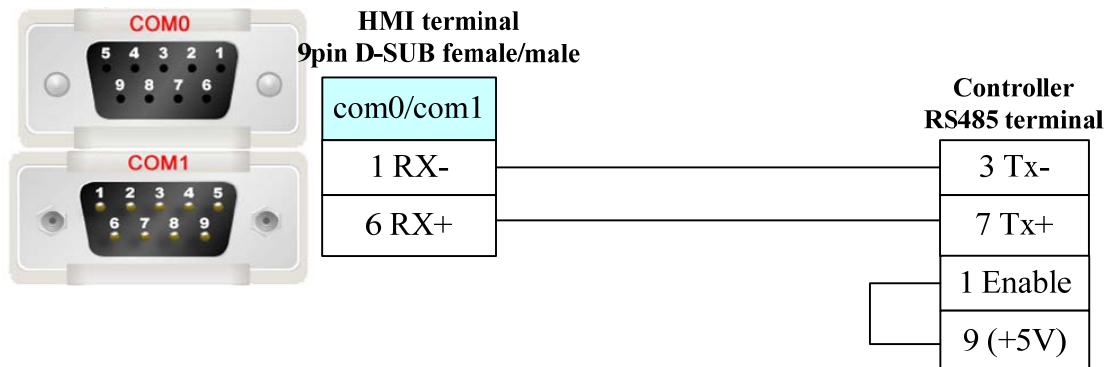

PMAC Motion Controller

Serial Communication

Series	CPU	Link Module	Driver
PC/104	PC/104	RS232 on the CPU unit	PMAC series

System configuration

Series	CPU	Link Module	COMM Type	Parameter	Cable
PC/104	PC/104	RS232 on the CPU unit	RS232	Setting	Your owner cable

Communication Setting

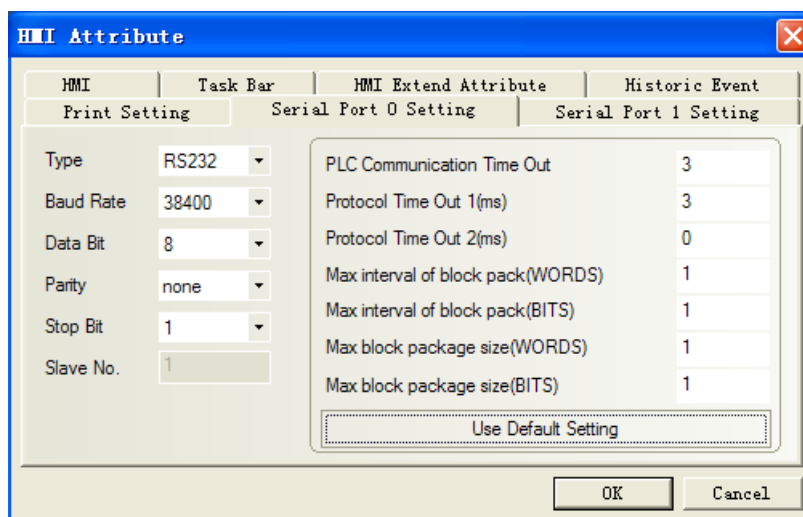

Supported Device

Device	Bit Address	Word Address	Format	Notes
I variable	-----	I 0-9999	DDDD	R/W
M variable	-----	M 0-9999	DDDD	R/W
P variable	-----	P 0-9999	DDDD	R/W
Q variable	-----	Q 0-9999	DDDD	R/W
I variable Float	-----	I_float 0-9999	DDDD	R/W
P variable Float	-----	P_float 0-9999	DDDD	R/W
Q variable Float	-----	Q_float 0-9999	DDDD	R/W
report position of motor		POS 0	D	R
report velocity of motor		VEL 0	D	R
report following error of motor		FER 0	D	R

common manual and programming command		ORD/JOG* 0-9999	DDDD	W
Run current program		RUN 0-9999	DDDD	W
Halt program		HLT 0-9999	DDDD	W

Note: Some addresses in I variable devices are on with hex number, when single float number on, all bits which can't be transformed into hex numbers will be "0"

PMAC common manual commands

- (0) ORD/JOG 0000: j+.: continual positive rotation command
- (1) ORD/JOG 0010: j- : continual reverse rotation command
- (2) ORD/JOG 0020: j/ : stop command
- (3) ORD/JOG 0030: j=constant
- (4) ORD/JOG 0040: j: constant
- (5) ORD/JOG 0050: j ^
- (6) ORD/JOG 0060: # n
- (7) ORD/JOG 0070: home (hm): manual reset zero commands
- (8) ORD/JOG 0080: homez (hmz): manual reset zero position commands

PMAC common programming commands

- (0) ORD/JOG 0100: & n
- (1) ORD/JOG 0110: B m R
- (2) ORD/JOG 0120: B m S
- (3) ORD/JOG 0130: A (ctrl A): Stop movement program
- (4) ORD/JOG 0140: K (ctrl K): Stop movement program and close enable signal
- (5) ORD/JOG 0150: Enable PLC n: Enable PLC, n indicates prog no. of PLC, range 0-31
- (6) ORD/JOG 0160: Disable PLC n: Disable PLC, n indicates prog no. of PLC, range 0-31

Cable Diagram

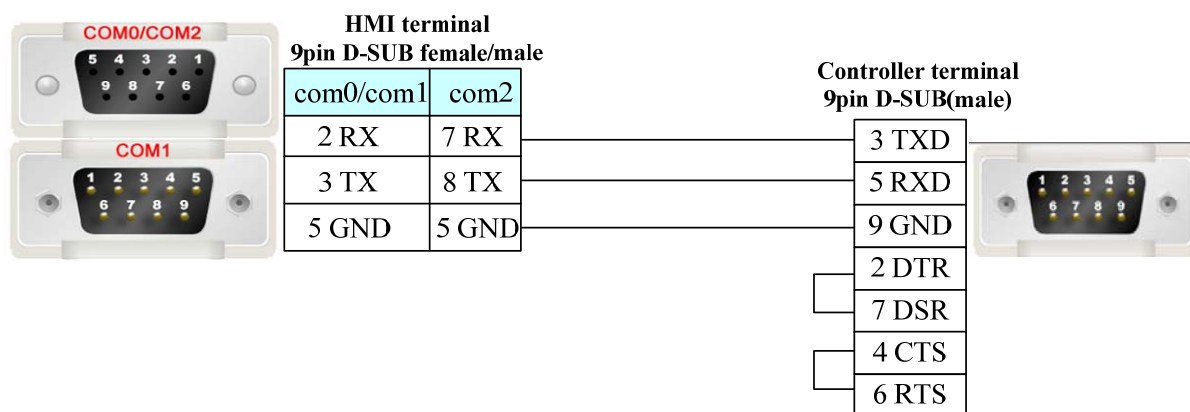

Power-one AURORA Wind Inverter

Serial Communication

Series	CPU	Link Module	Driver
AURORA	PVI-6000-OUTD-US-W	RS485 on the port	Aurora PV

System configuration

Series	CPU	Link Module	COMM Type	Parameter	Cable
AURO RA	PVI-6000-OUTD-US-W	RS485 on the port	RS485	Setting	Your owner cable

Communication Setting

Default communication: 19200, 8, none, 1; station: 2

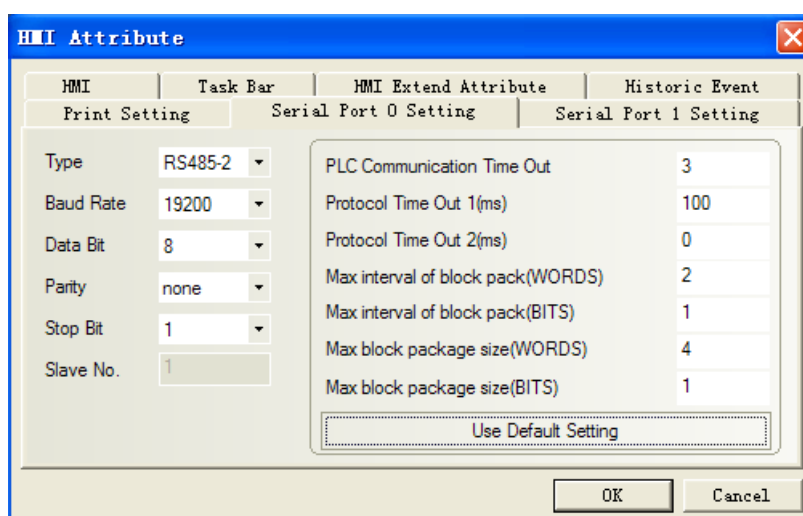

Supported Device

Device	Bit Address	Word Address	Format
Time Register (double word)	-----	Time 0-9999.7	DDDDD.0
Energy Register (double word)	-----	Energy 0-9999.7	DDDDD.0
Status variable Register (double word)	-----	Measure 0-9999.7	DDDDD.0
Hardware version (double word)	-----	Fireware 0-9999.7	DDDDD.0
Software version (double word)	-----	Version 0-9999	DDDD
Device sequence No. (double word)	-----	SN 0-9999	DDDD
Device ID (double word)	-----	PN 0-9999	DDDD
Device work status		State 0-9999	DDDD

Cable Diagram

Note: AURORA Wind Inverter supports two connection modes, please refer to the manual of power-one Corporation for details.

1. Connect with RS485 port

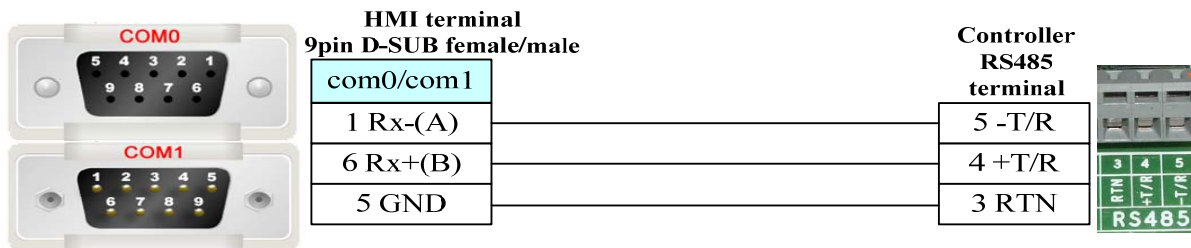

2. Connect with RJ12

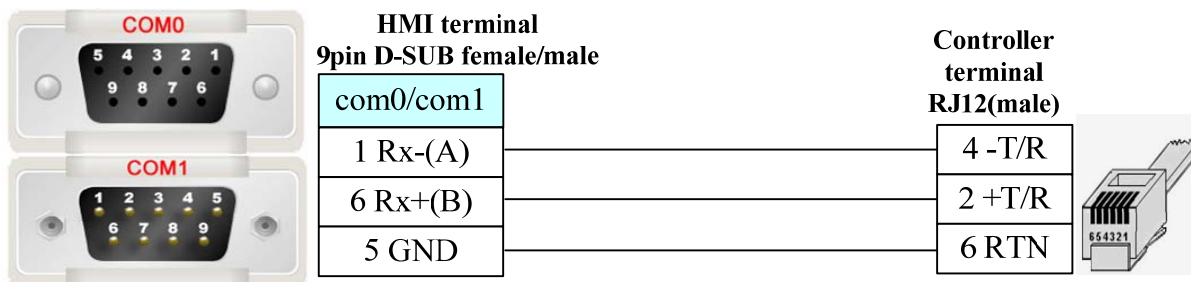

Profibus Slave

Serial Communication

Series	CPU	Link Module	Driver
SIMATIC S7-300/400	ALL CPUs that have the DP port	PROFIBUS DP port on the External Device	Profibus Slave
Other company devices which support PROFIBUS DP Master		PROFIBUS DP port	

System configuration

Series	CPU	Link Module	Parameter	SIP Type
SIMATIC S7-300/400	ALL CPUs that have the DP port	PROFIBUS DP port on the External Device	Setting	Profibus
Other company devices which support PROFIBUS DP Master		PROFIBUS DP port	Setting	

Communication Setting

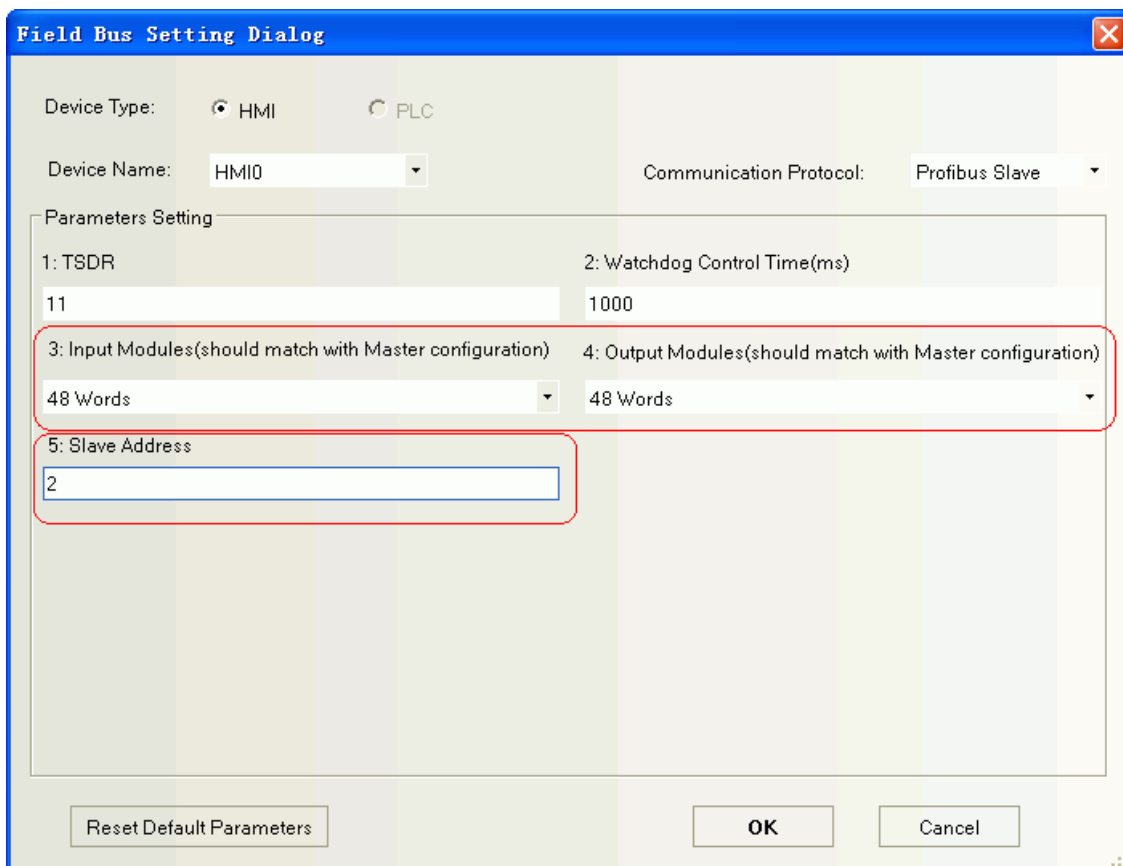

Note: Input and Output Modules should match with Master configuration

PLC setting

Note: you can find `eview.gsd` in the `fieldbus` file of `EV5000 Installation Directory`, or you can download from www.kinco.cn.

1. Setup `eview.gsd` file

Setup GSD file in the s7-300 software.

Process:

- (1) . Closed all the station in HW Config
- (2) .choose "option" > "install GSD file".
- (3) .Find out the folder of `eview.gsd`.
- (4) .Choose `eview.gsd`, and then click the install button.

You can find the ico in PROFIBUS DPMMI, after installing

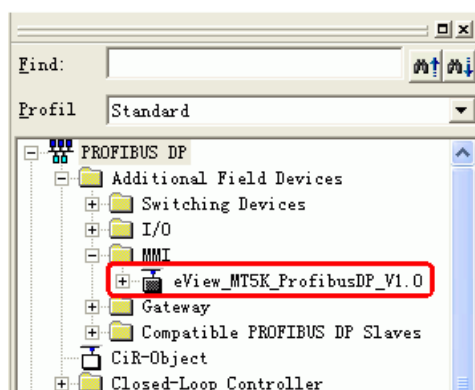

2. configuration setting

- (1) make a new project in s7-300 through the guide
- (2) we must use OB82, OB86, OB100, OB121 and OB122 in BLOCK, or system will go wrong when PLC is power-up.
- (3) dblclick HW Config, choose “DP” and right click “add master station”.

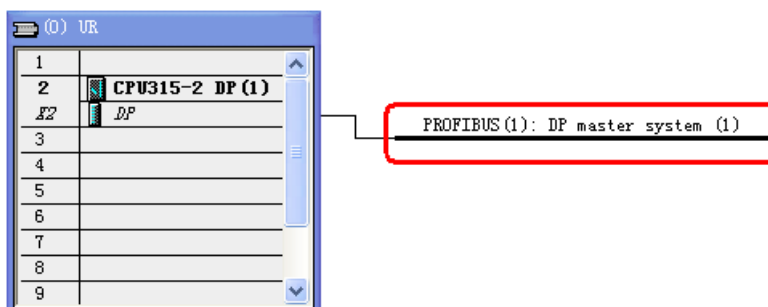
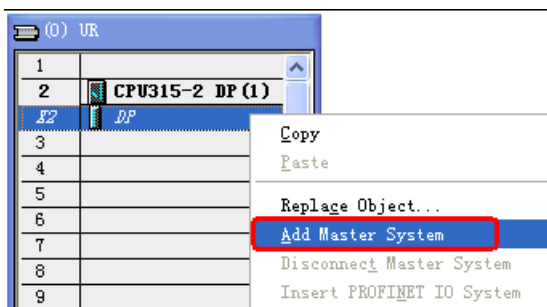

- (4) right click, choose “insert object”

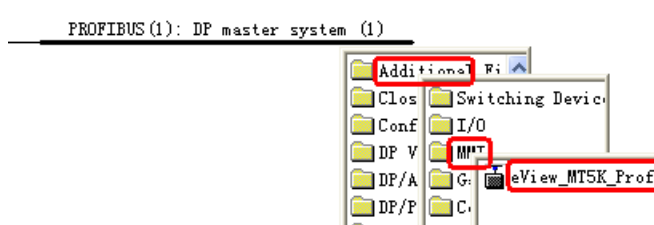

Click “eview_MT5K_ProfibusDP_V1.0”, set address.

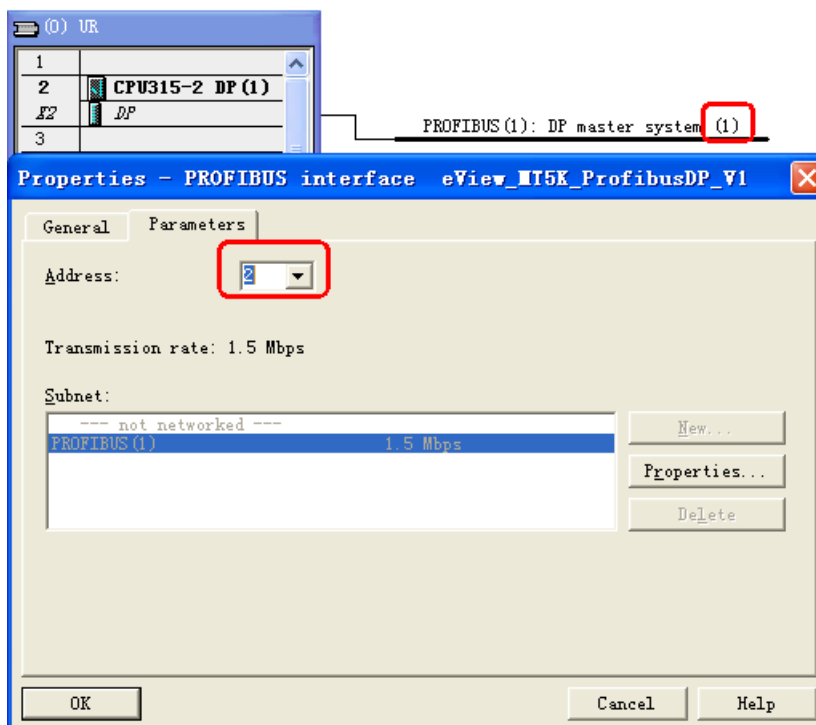

Note: the address No. of DP master station and slave can not be same.

(5) input and output setting

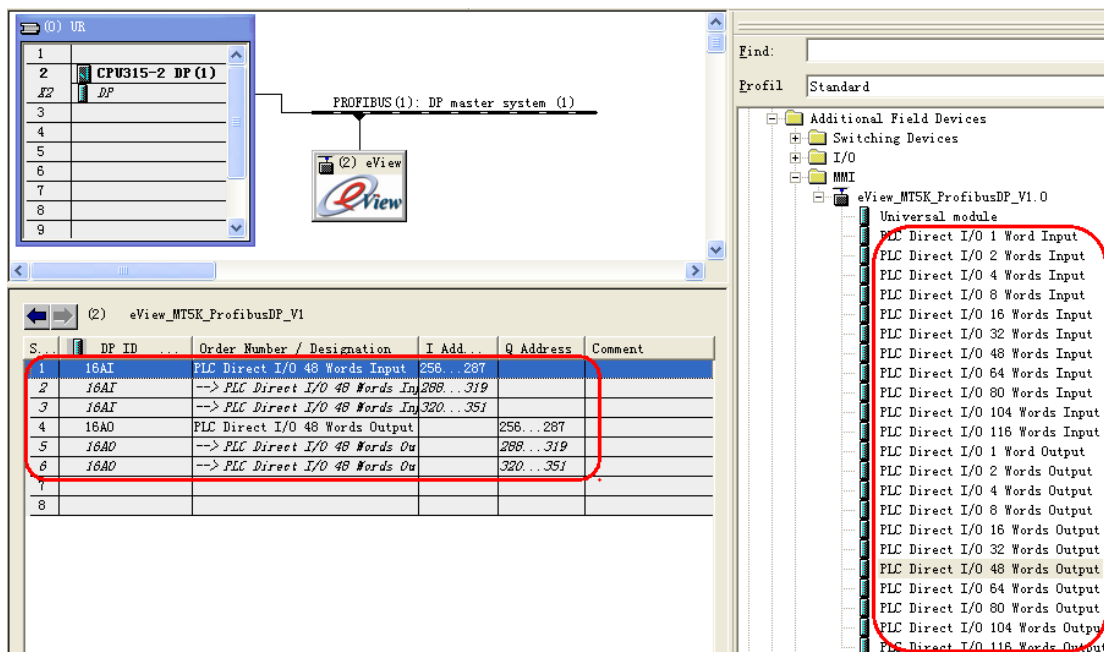

(6) Profibus DP Slave has adaption function, you can change the transmission rate of DP master station, maximum is 12Mbps.

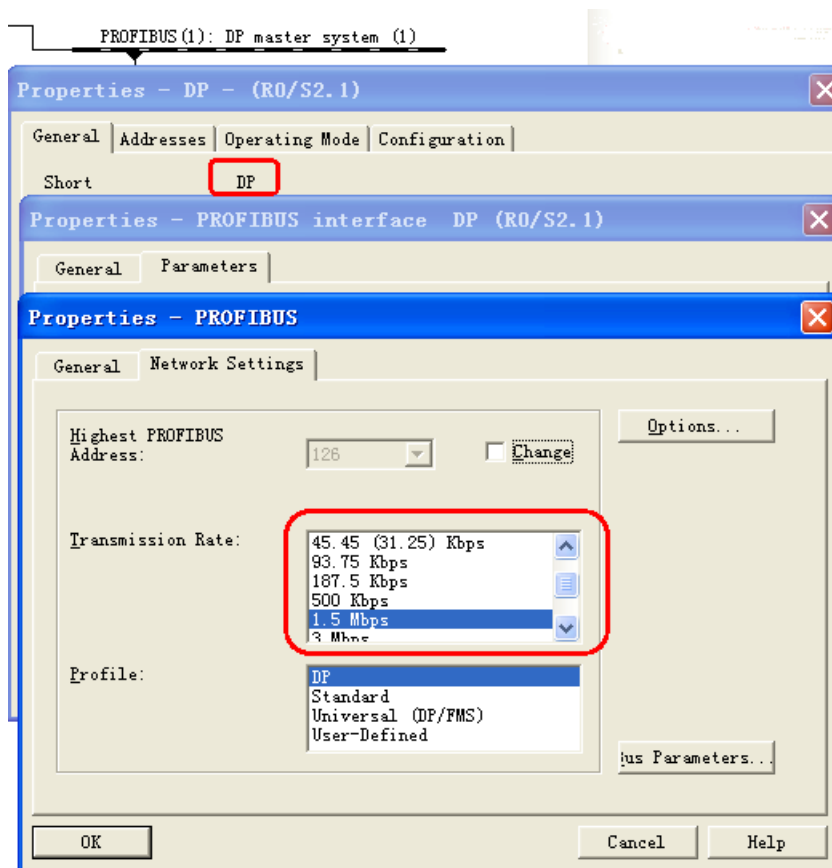

(7) Double click slave ico, then set User_Prm_Data (0) =01

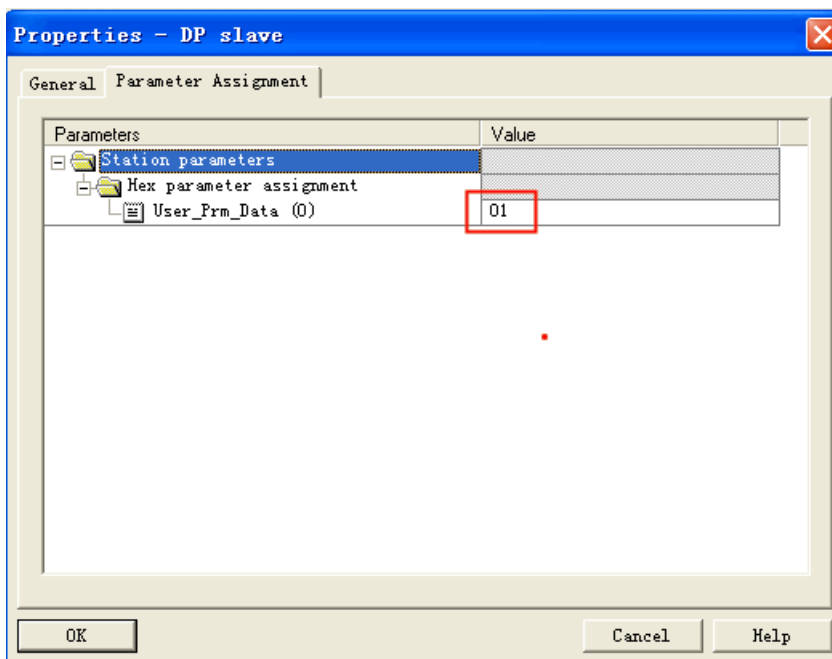

Supported Device

Device	Bit Address	Word Address	Format	Notes
Direct I/O Input	LW.B8500.0~8615.F	————	DDDD.H	
Direct I/O Output	LW.B8000.0~8115.F	————	DDDD.H	

Direct I/O Input	————	LW8500~8615	DDDD	correspond PIW
Direct I/O Output	————	LW8000~8115	DDDD	correspond PQW
Direct I/O Input	————	LW8500~8615(Data width is dword)	DDDD	correspond PID
Direct I/O Output	————	LW8000~8115(Data width is dword)	DDDD	correspond PQD

Note: When use either PID or PQD, you must set User_Prm_Data (0) =1 if HMI communication with the DP port of Siemens; Other company devices which support PROFIBUS DP Master, default User_Prm_Data (0) =0.

Cable Diagram

A-type violet cable

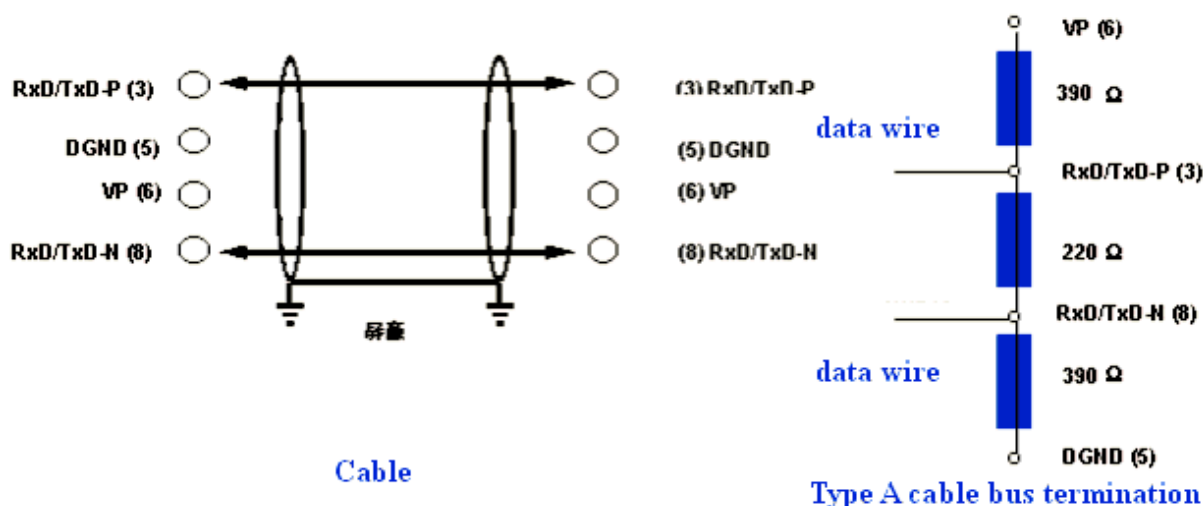

RF-IC (Card Reader)

Serial Communication

Series	CPU	Link Module	Driver
RF-IC	RF-IC	RS232 on the CPU unit	RF-IC

System configuration

Series	CPU	Link Module	COMM Type	Parameter	Cable
RF-IC	RF-IC	RS232 on the CPU unit	RS232	Setting	Your owner cable

Communication Setting

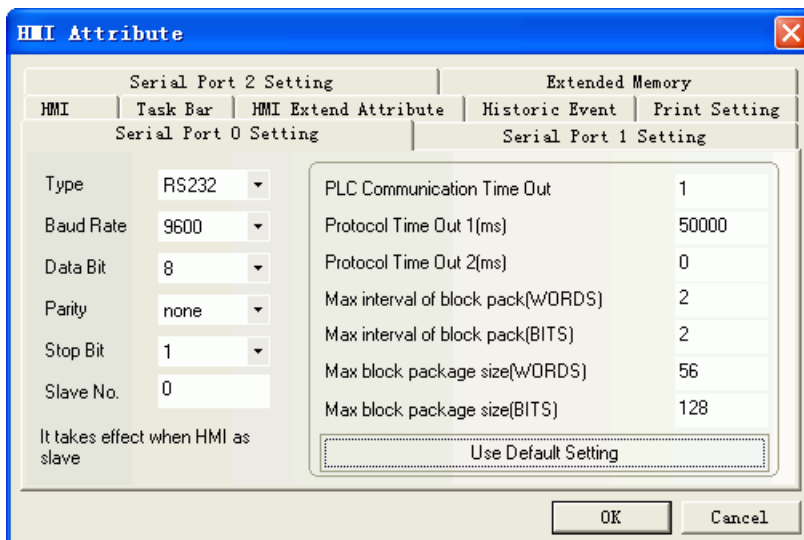

Supported Device

Device	Bit Address	Word Address	Format	Notes
Bit	LB 8999	-----	DDDD	
	-----	LW 8900	DDDD	

Note: LB8999 means bar code has received or not. 1 means data has received.

Cable Diagram

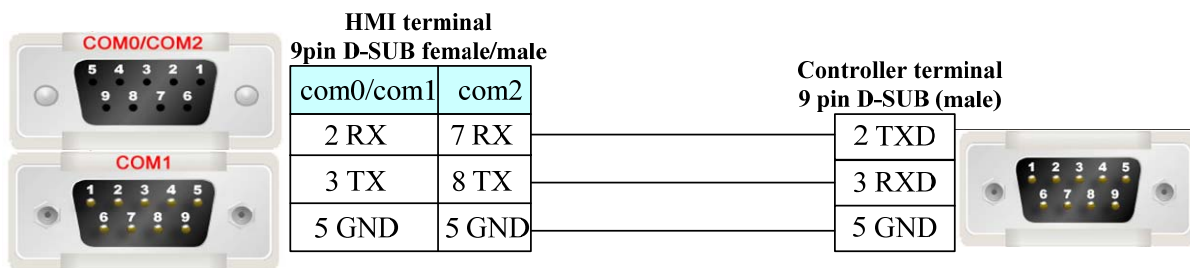

Saia-Burgess

Serial Communication

Series	CPU	Link Module	Driver
PCS	PCS1.C8	RS232 on the CPU unit	Saia SBus
PCD	PCD2.M110	RS232 on the CPU unit	
	PCD2.M120		
	PCD2.M150		
	PCD2.M170		
	PCD2.M480		

Systems Configuration

Series	CPU	Link Module	COMM Type	Parameter	Cable
PCS	PCS1.C8	RS232 on the CPU unit	RS232	Setting	Your owner cable
		RS485 on the CPU unit	RS485-4	Setting	Your owner cable
PCD	PCD2.M110	RS232 on the CPU unit	RS232	Setting	Your owner cable

Communication Setting

Saia default communication: 9600, 8, none, 1; station: 80

RS232

The screenshot shows the 'HMI Attribute' dialog box with the 'Serial Port 0 Setting' tab selected. The 'Type' is set to 'RS232'. The communication parameters are: Baud Rate: 9600, Data Bit: 8, Parity: none, Stop Bit: 1, and Slave No.: 1. The PLC communication parameters are: PLC Communication Time Out: 3, Protocol Time Out 1(ms): 50, Protocol Time Out 2(ms): 3, Max interval of block pack(WORDS): 2, Max interval of block pack(BITS): 8, Max block package size(WORDS): 64, and Max block package size(BITS): 128. There is a 'Use Default Setting' button and 'OK' and 'Cancel' buttons at the bottom.

RS485

The screenshot shows the 'HMI Attribute' dialog box with the 'Serial Port 0 Setting' tab selected. The 'Type' is set to 'RS485-2'. The communication parameters are: Baud Rate: 9600, Data Bit: 8, Parity: none, Stop Bit: 1, and Slave No.: 1. The PLC communication parameters are: PLC Communication Time Out: 3, Protocol Time Out 1(ms): 50, Protocol Time Out 2(ms): 3, Max interval of block pack(WORDS): 2, Max interval of block pack(BITS): 8, Max block package size(WORDS): 64, and Max block package size(BITS): 128. There is a 'Use Default Setting' button and 'OK' and 'Cancel' buttons at the bottom.

Supported Device

Device	Bit Address	Word Address	Format	Notes
Input	I0-8091	-----	DDDDD	
Output	Q0-8091	-----	DDDDD	

Flag	F0-8091	-----	DDDD	
Timer	-----	T0-1599	DDDD	
Counter	-----	C0-1599	DDDD	
Register	-----	R0-4095	DDDD	
Register (support single float point)	-----	R_Float0-4095	DDDD	

Cable Diagram

Pcs1.c8 RS232 communication cable

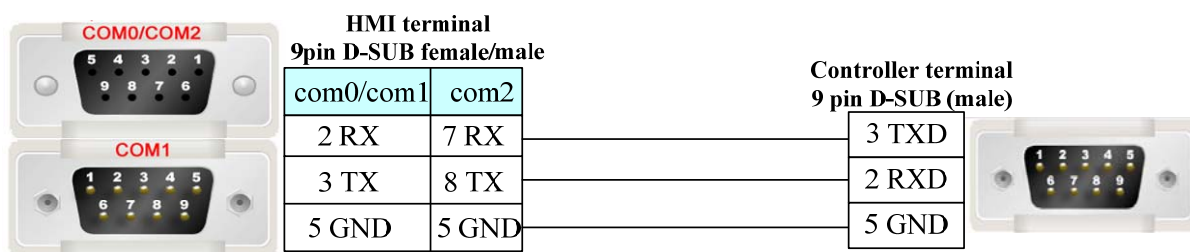

PCD2.M110 RS232 communication cable

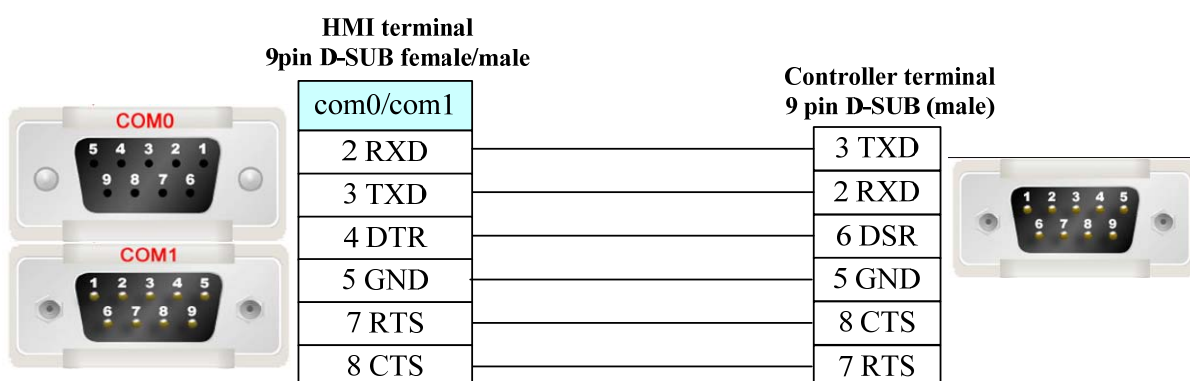

Pcs1.c8 RS485 communication cable

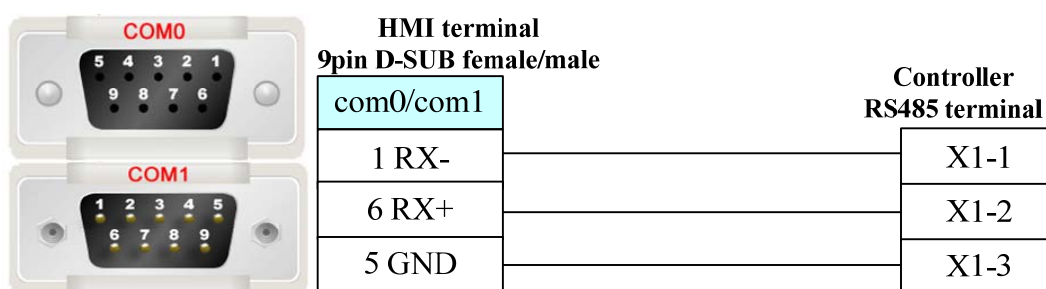

Sailors D9 (Temperature Controller)

Serial Communication

Series	CPU	Link Module	Driver
Sailors D9	Swp-T16-80-08-N	RS232 on the CPU unit	Sailors D9

System configuration

Series	CPU	Link Module	COM Type	Parameter	Cable
Sailors D9	Swp-T16-80-08-N	RS485 on the CPU unit	RS485	Setting	Your owner cable

Communication Setting

Sailors D9 RS485 communication

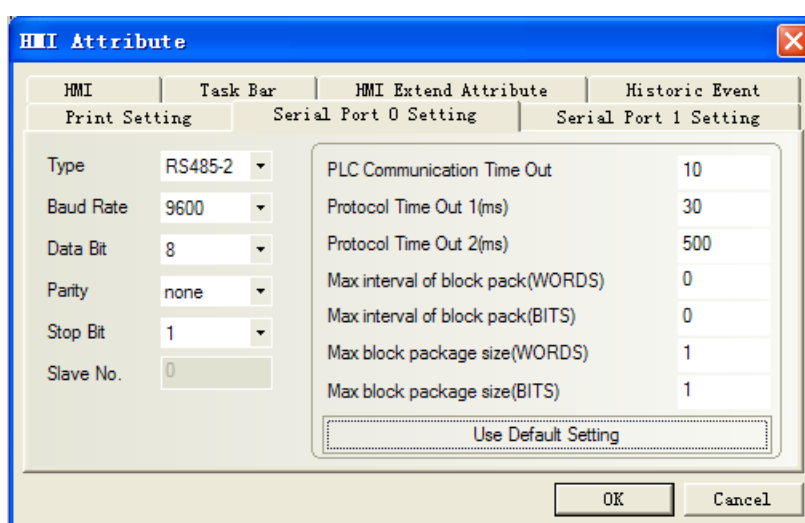

Supported Device

Device	Bit Address	Word Address	Format	Notes
Channel Sample Value	-----	CH 0~16	DD	
Channel Indexing	-----	SN 1~16	DD	

Cable Diagram

Sailors D9 RS485 communication cable

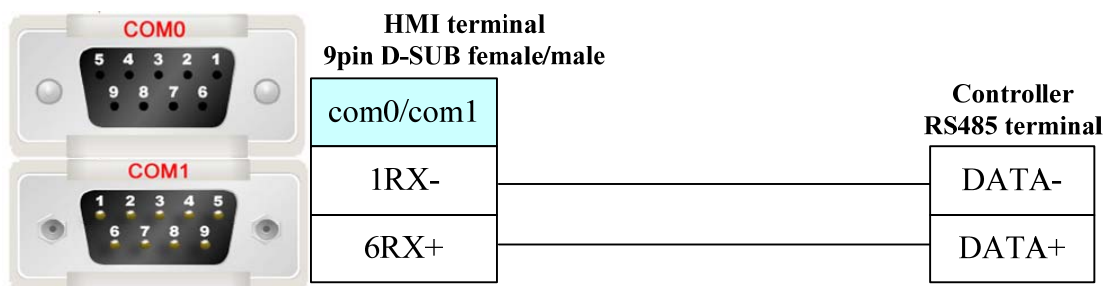

Schneider Electric, Ltd.

Serial Communication

Series	CPU	Link Module	Driver
Micro	TSX3705001 TSX 37 05 028DR1 TSX 37 08 056DR1 TSX 37 10 128DT1 TSX 37 10 128DR1 TSX 37 10 128DTK1 TSX 37 10 164DTK1 TSX 37 10 028AR1 TSX 37 10 028DR1 TSX 37 21 101 TSX 37 22 101 TSX 37 21 001 TSX 37 22 001	TER port on the CPU	Schneider Modicon Uni-TelWay Modbus RTU
Premium	TSX P57 103M TSX P57 153M TSX P57 203M TSX P57 253M TSX P57 303M TSX P57 353M TSX P57 453M	TER port on the CPU	
Nano	TSX 07 3L □□□□28 TSX 07 30 10□□□□ TSX 07 31 16□□□□ TSX 07 31 24□□□□ TSX 07 32 □□□□28 TSX 07 33 □□□□28	Programming port on CPU	
Twido	TWD LCAA 10DRF TWD LCAA 16DRF TWD LCAA 24DRF TWD LMDA 20DTK TWD LMDA 20DUK TWD LMDA 20DRT TWD LMDA 40DTK TWD LMDA 40DUK	RS485 on the CPU unit	Schneider Twido Modbus RTU

System configuration

Series	CPU	Link	Driver	COMM	Parameter	Cable
--------	-----	------	--------	------	-----------	-------

		Module		Type						
Modicon TSX	TSX3705001	RS485 on the CPU unit	Schneider Modicon Uni-TelWay	RS232	Setting	Your owner cable				
	TSX3705001			RS485-2	Setting	Your owner cable				
	TSX 37 05 028DR1									
	TSX 37 08 056DR1									
	TSX 37 10 128DT1									
	TSX 37 10 128DR1									
	TSX 37 10 128DTK1									
	TSX 37 10 164DTK1									
	TSX 37 10 028AR1									
	TSX 37 10 028DR1									
	TSX 37 21 101									
	TSX 37 22 101									
	TSX 37 21 001									
	TSX 37 22 001									
	TSX3705001			RS485 on the CPU unit	Modbus RTU	RS232	Setting	Your owner cable		
	TSX3705001					RS485-2	Setting	Your owner cable		
	TSX 37 05 028DR1									
	TSX 37 08 056DR1									
	TSX 37 10 128DT1									
	TSX 37 10 128DR1									
TSX 37 10 128DTK1										
TSX 37 10 164DTK1										
TSX 37 10 028AR1										
TSX 37 10 028DR1										
TSX 37 21 101										
TSX 37 22 101										
TSX 37 21 001										
TSX 37 22 001										
Twido	TWD LCAA 10DRF	RS485 on the CPU unit				RS232	Setting	Your owner cable		
	TWD LCAA 16DRF					RS485-2	Setting	Your owner cable		
	TWD LCAA 24DRF									
	TWD LMDA 20DTK									
	TWD LMDA 20DUK									
	TWD LMDA 20DRT									
	TWD LMDA 40DTK									
	TWD LMDA 40DUK									

Communication Setting

Uni-TelWay protocol default communication: 9600, 8, odd, 1; station:1.

[RS232 communication](#)

Note: Cable by Schneider Electric Industries, Rotary switch setting: 2(TER Direct)

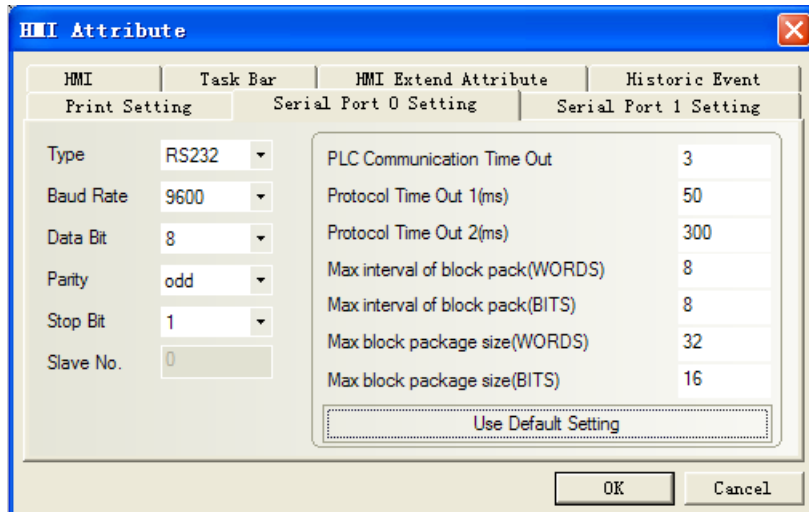

RS485 communication

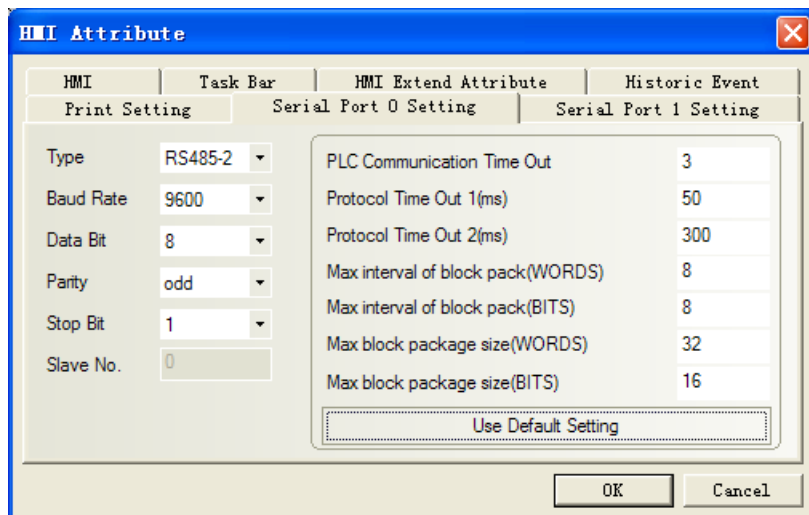

protocol default communication: 9600, 8, even, 1; station: 1.

RS232 communication

Note: Cable by Schneider Electric Industries, Rotary switch setting: 3(OTHER Direct)

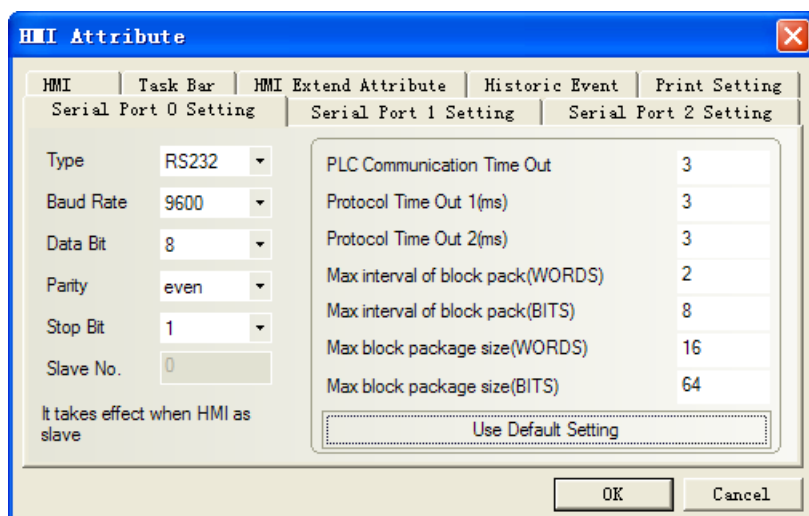

RS485 communication

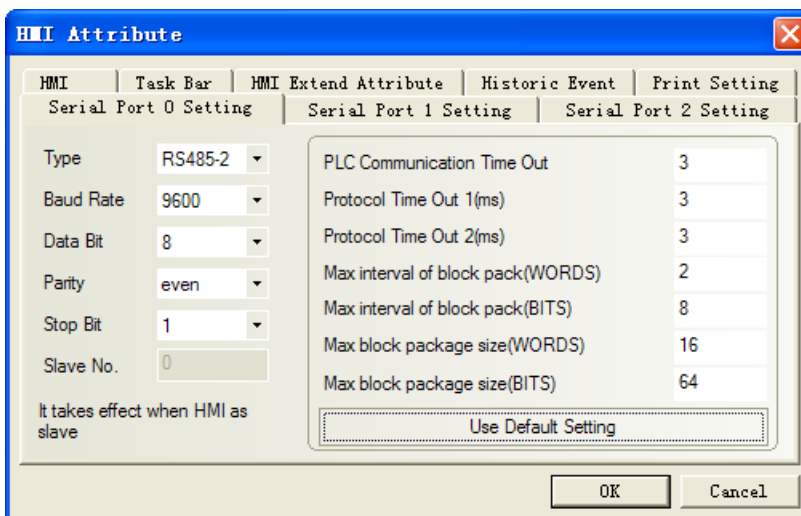

PLC Setting

- Sort menu-→“modicum telemecanique” → “xway driver manager” to set communication parameter

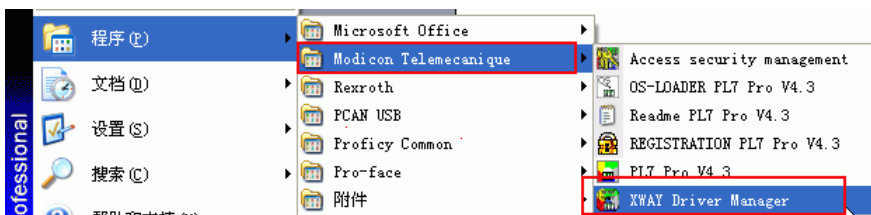

- Pop-up to select “unitelway driver”→”configuration”→”edit” to modify communication parameter

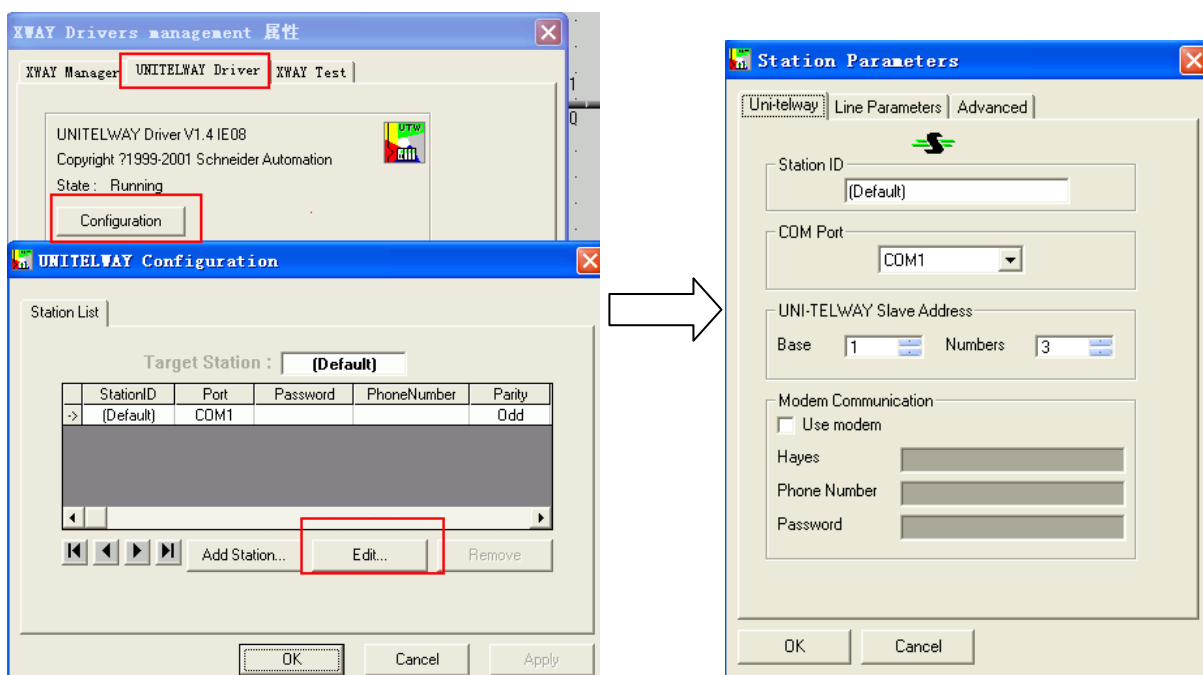

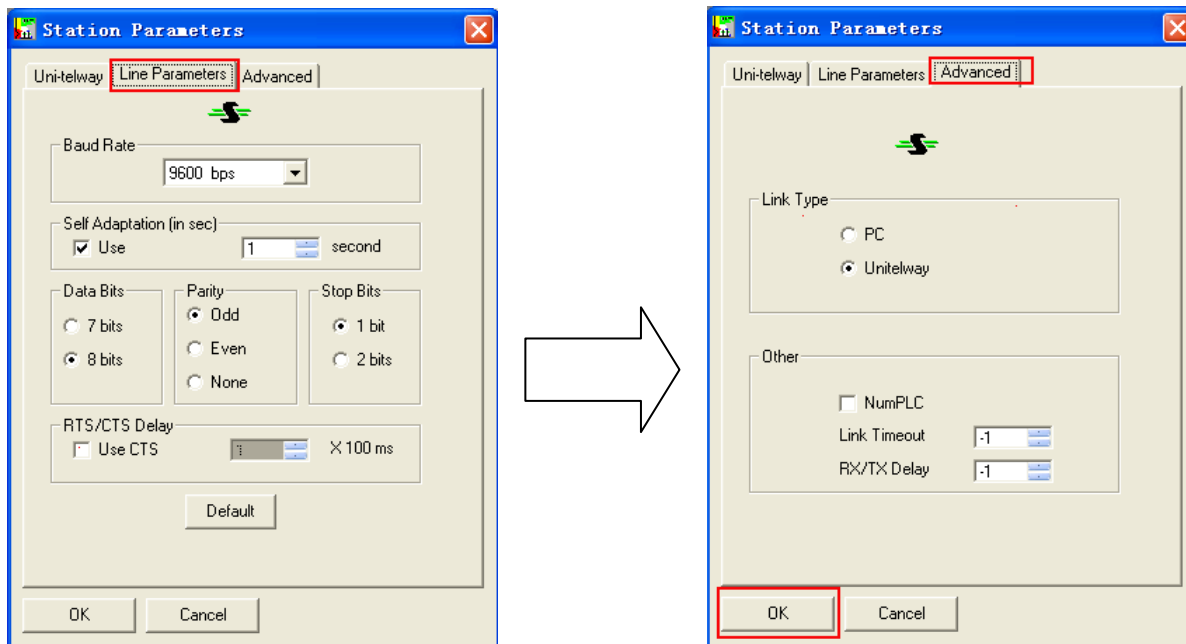

3. Press "ok" and pop up the following tips

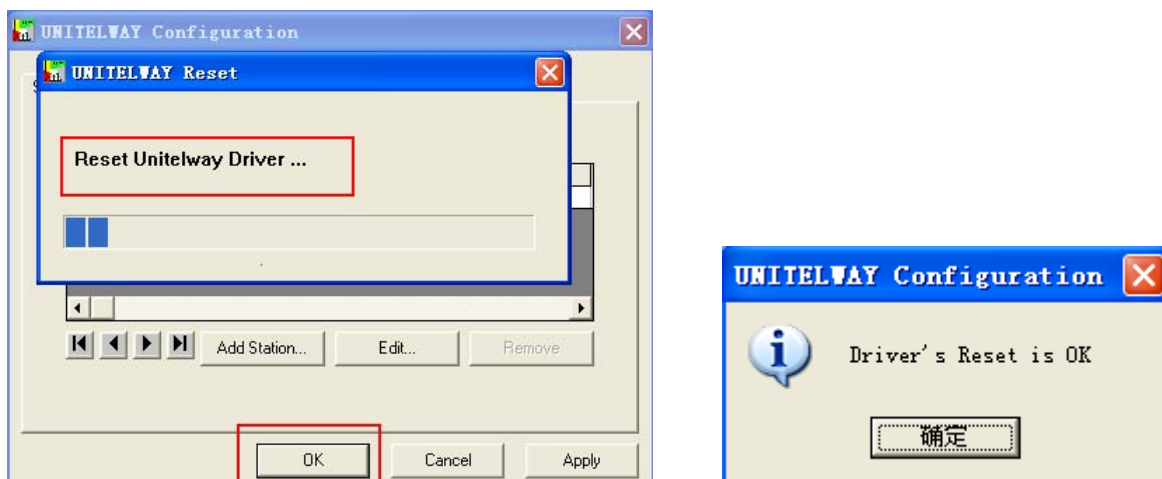

4. And then click "xway test" → "connect", if the connection is successful, it will clue "connected"

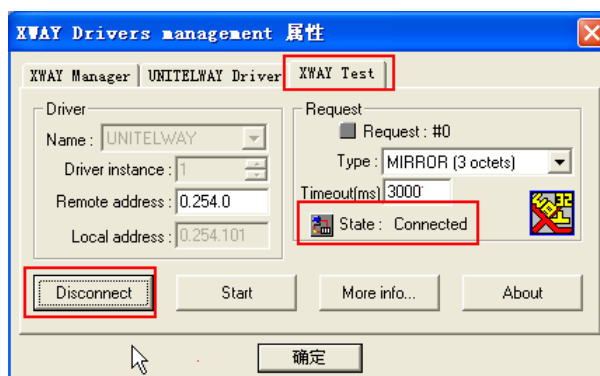

5. Open the PL7 software → "create new project" → click "hardware configuration" → double-click pop-up window "comm"

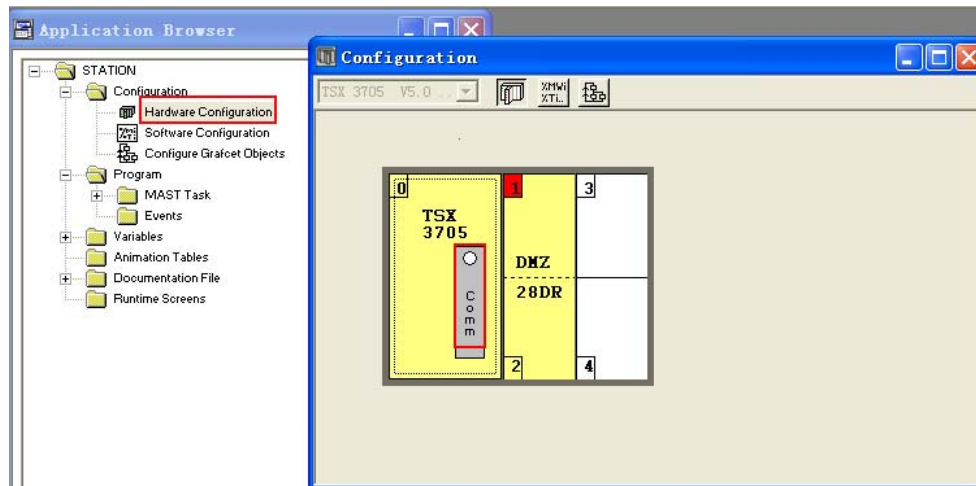

Unitel-way protocol setting:

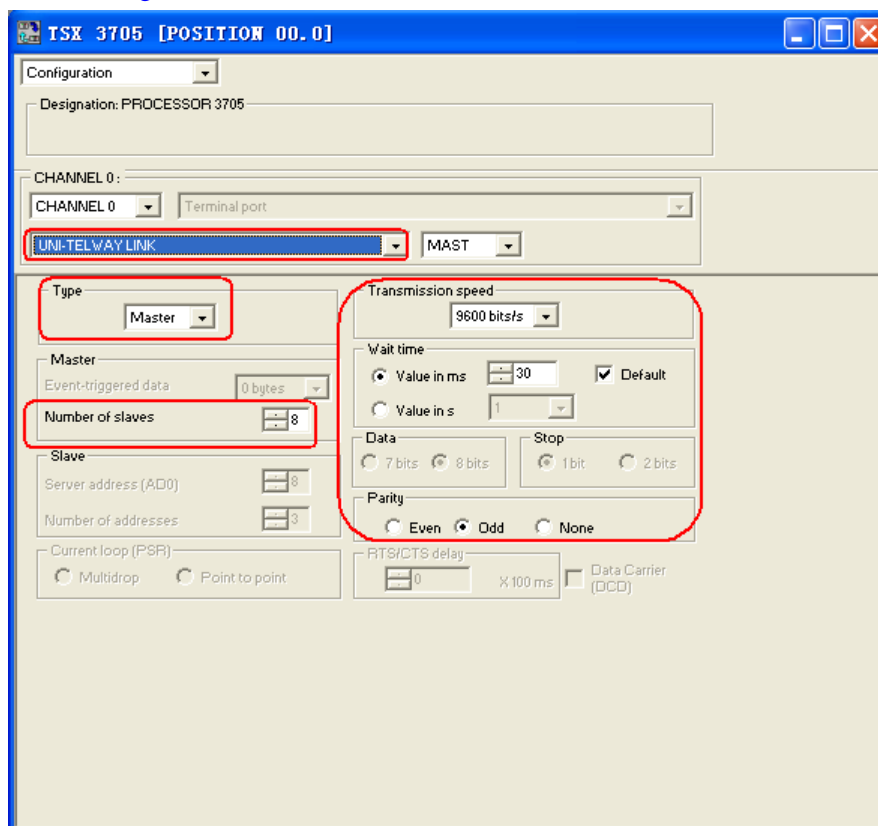

Modbus protocol setting::

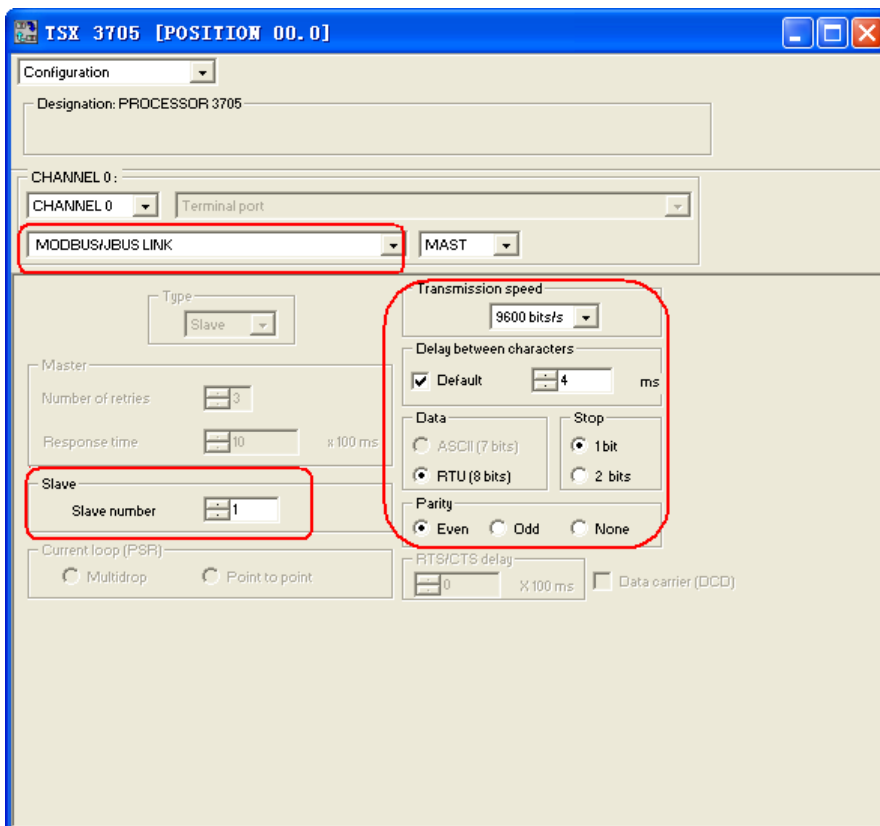

6. Setting up the configuration and download the project to the PLC

Schneider Twido Modbus RTU protocol default communication: 19200, 8, none, 1; station: 1

*Note: Cable by Schneider Electric Industries, Rotary switch setting: 2(TER Direct).
RS232 communication*

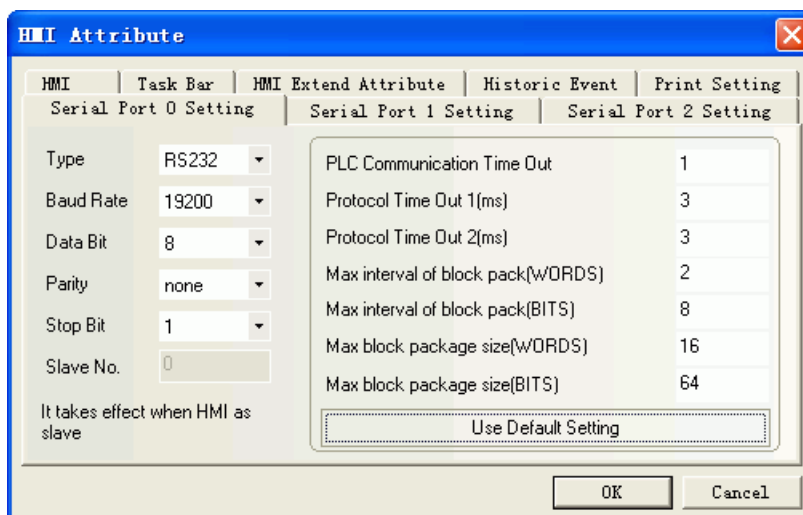

RS485communication

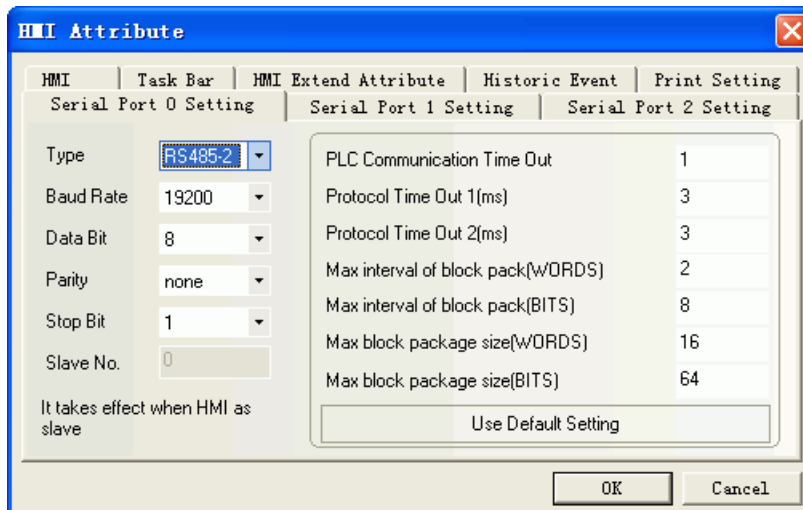

Twido Software setting

1. Specify a large number for the internal word in the “controller > memory use >edit” and load the configuration into the PLC to open the memory area for the words. If set the internal word 3000, you can use address of MW before 3000.

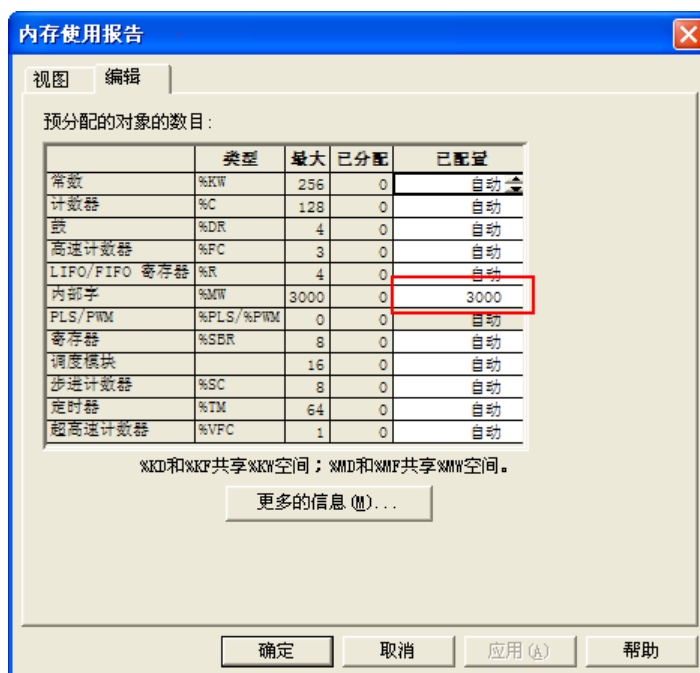

2. You must program a coil with maximum address to open the memory area for the Bits. If you program a coil with 127 addresses, then the address before 127 can be used.



Supported Device

Modicon TSX

Device	Bit Address	Word Address	Format	Notes
--------	-------------	--------------	--------	-------

Internal Relay	S00000-32767	-----	DDDDD	
Auxiliary Relay	M00000-32767	-----	DDDDD	
Data Register Relay	MW.B0000-9999.F	-----	DDDD.H	
Data register	-----	MW0000-7999	DDDD	
Data register double word	-----	MD0000-7999	DDDD	

Twido

Device	Bit Address	Word Address	Format	Notes
Output Relay	0X 1-9999	-----	DDDD	
Input Relay (read only)	1X 1-9999	-----	DDDD	
Input Register (read only)	-----	3X 1-9999	DDDD	
Output Register	-----	4X 1-9999	DDDD	

Note:

The M register in the software of TWIDO corresponds to 0X in the ev5000 software; MW corresponds to 4X. The HMI's address must plus 1 to correspond with the address of PLC.

e.g.: M0 corresponds to 0X1.

Don't use 1X, 3X device, because there is no correspondence with the PLC.

Cable Diagram

Uni-TelWay RS232

Cable recommended by Schneider Electric Industries, Rotary switch setting: 2(TER Direct)
(Add a direct line)

Uni-TelWay RS485

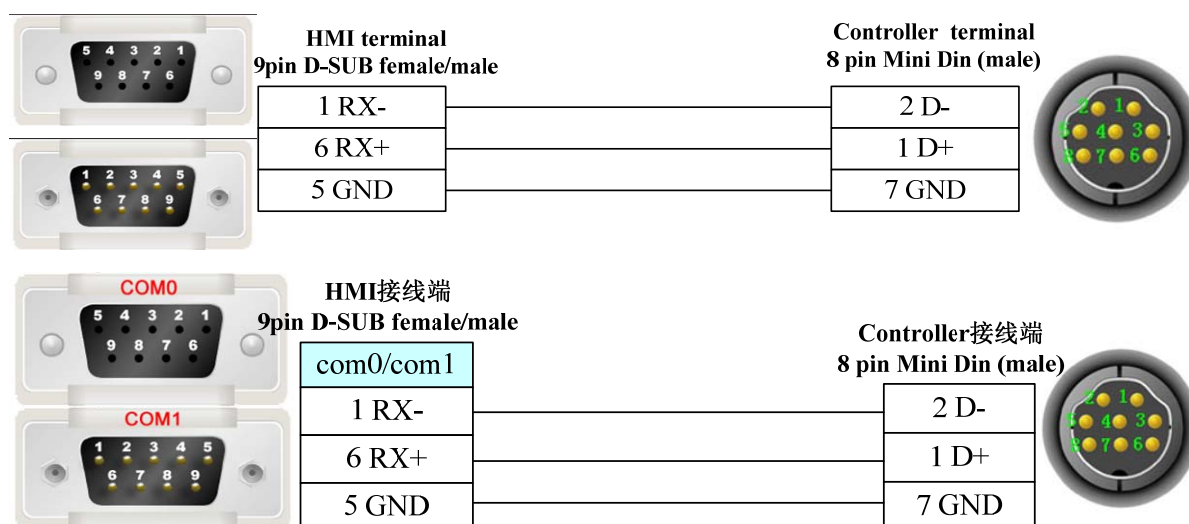

Modicon modbus Protocol RS232

PLC software setting: "Hardware Configuration" → double click "Ccom" to select "MODBUS/BUS LINK"; others are default parameters.

Cable recommended by Schneider Electric Industries, Rotary switch setting: 3 (OTHER Direct)

Modicon modbus Protocol RS485

PLC software setting: "Hardware Configuration" → double click "Ccom" to select "MODBUS/BUS LINK"; Others are default parameters.

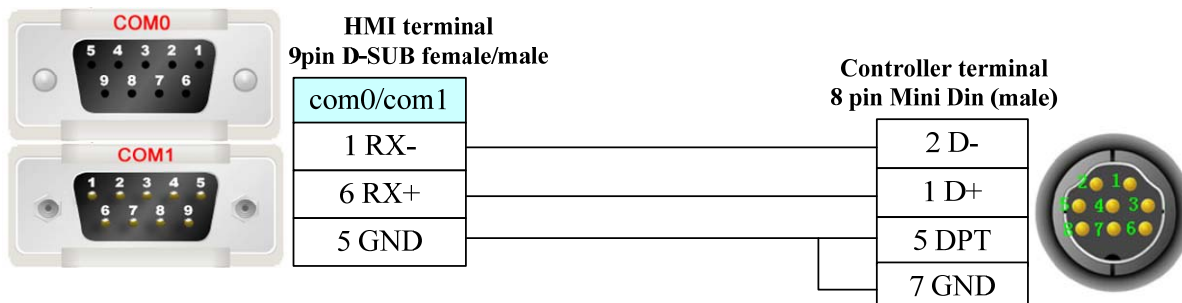

Twido RS232 communication cable

Cable recommended by Schneider Electric Industries

Twido RS485 communication cable

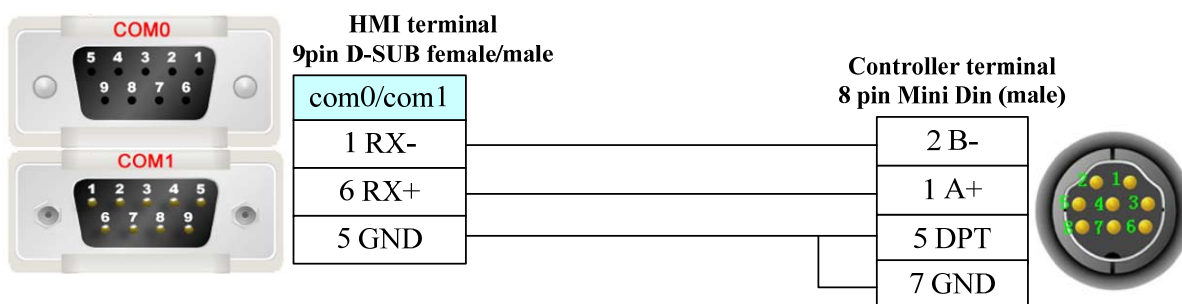

SHIMADEN FP23

Serial Communication

Series	CPU	Link Module	Driver
FP23	FP23	RS485 on the CPU unit	SHIMADEN FP23

System configuration

Series	CPU	Link Module	COMM Type	Parameter	Cable
FP23	FP23	RS485 on the CPU unit	RS485	Setting	Your owner cable

Communication Setting

RS485-2 default communication: 9600, 8, even, 1; station: 1

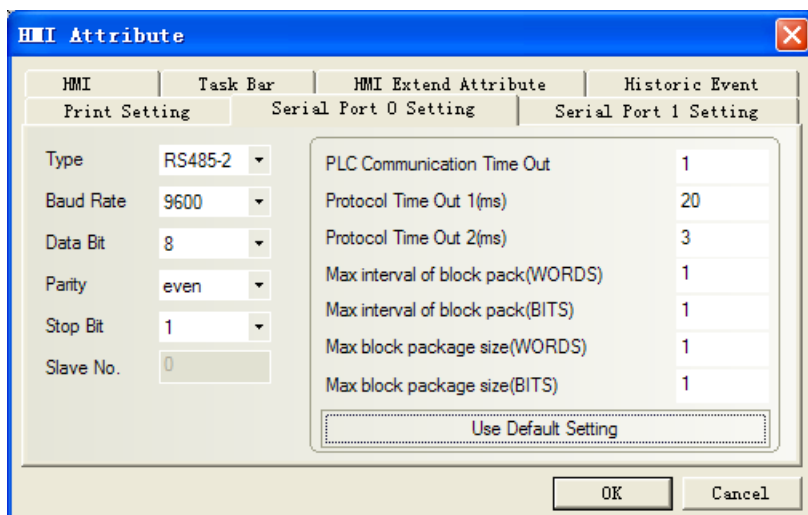

Supported Device

Device	Bit Address	Word Address	Format	Notes
State instructions(Write Only)	Ctrl_Write 184-252	-----	HHH	
Sequence code(Read Only)	-----	Array Code 0-3	H	
Basic parameter value (Read Only)	-----	Basic_Read 00-42	HH	
OUT1_W,OUT2_W(Write Only)	-----	Out_Write 0-1	H	
PV1, PV2 (Read Only)	-----	PV_Read 0-1	H	
Reference (Read & Write)	-----	Reference 300-952	HHH	

Basic_Read operatable address

PLC addr (HEX)	Parameter	R/W	Parameters mean
00H	PV_W	Read	Measurements
01H	SV_W	Read	Setting value
02H	OUT1_W	Read	Output1 value
03H	OUT2_W	Read	Output2 value
04H	EXE_FLG	Read	Execute_flag (no execute=0)
05H	EV_FLG	Read	Event_flag (no event output 0000)
06H	Reserve	Read	value:0000H
07H	EXE_PID	Read	Execute_PID No.
09H	HB_W	Read	Heater break alarm
0AH	HL_W	Read	Heater loop alarm
0BH	DI_FLG	Read	DI status flag
10H	UNIT	Read	Measurement unit
11H	RANGE	Read	Measuring range
12H	CJ	Read	Cold junction compensation 0=Internal 1=External
13H	DP	Read	Decimal position, 0=none 1=0.1 2=0.01 3=0.001 4=0.0001

14H	SC_L	Read	PV lower limit side scaling
15H	SC_H	Read	PV higher limit side scaling
16H	DPFLG	Read	0=show 1=cancel
20H	E_PRG	Read	Execute flag of program
21H	E_PTN	Read	Execution step No. of step loop
22H	Reserve	Read	Reserve
23H	E_RPT	Read	Curve repeat time
24H	E_STP	Read	Execution count of step loop
25H	E_TIM	Read	Step time
26H	E_PID	Read	PID No. execution
29H	E_STPRPT	Read	Number of steps
42H	POSI	Read	Seven switches (feedback 0-100)

Ctrl_Write operatable address example

PLC addr (HEX)	Parameter	R/W	Parameters mean
184H	AT	write	Execution automatically adjustment 0: OFF 1: ON
18CH	COM	write	Communication Protocol: 0: LOC 1: COM

Reference operatable address example

PLC Addr (HEX)	Parameter	R/W	Parameters mean
300H	FIX_SV	R/W	FIX mode SV: in the limit range of SV
460H	PB21	R/W	ratio coefficient: 0.0 to 999.9%(0.0=OFF)

About device address details, please refer to the FP23 communication protocol.

Show: H indicates HEX

Note: 1、Setting the parameters of ADDR address, the settings must be the same as the corresponding PLC station.

2、When Connecting multiple instruments, for distinguishing instruments, each instrument must be set different ADDR value.

Cable Diagram

FP23 programmable PID regulator of 8 point and 10 point must be shorted or communications failure

FP23 RS485 port

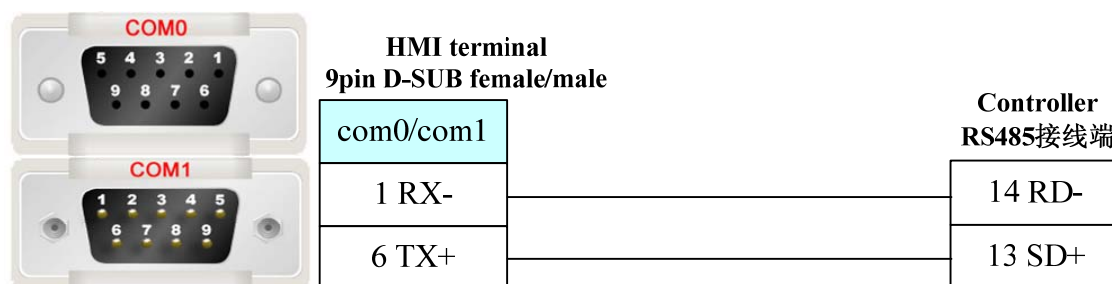

SIEMENS

Serial Communication

Series	CPU	Link Module	Driver
S7-200	CPU212 CPU214 CPU215 CPU216 CPU221 CPU222 CPU224 CPU226	RS485 on the CPU unit	Siemens S7-200
S7-200 CN	CPU224 XP CN CPU226 XP CN	RS485 on the CPU unit	
S7-300	CPU312IFM CPU313 CPU313C CPU314 CPU314IFM CPU315 CPU315-2 DP CPU316 CPU316-2 DP CPU318-2	MPI port on the CPU unit	1. Siemens S7-300/400 (PC Adapter) 2. Siemens S7-300/400 (via MPI port) *1
S7-400	CPU412-1 CPU412-2 DP CPU413-1 CPU413-2 DP CPU414-1 CPU414-2 DP CPU414-3 DP CPU416-1 CPU416-2 DP CPU416-3 DP CPU417-4	MPI port on the CPU unit	

Note: Don't live plug!!!

Ethernet Communication (Direct online simulation disable)

Series	CPU	Link Module	Driver
SIMATIC S7-200	CPU222 CPU224 CPU224 XP	CP 243-1 IT CP 243-1	Siemens S7-200 Network Slave

	CPU226		
--	--------	--	--

Serial System configuration

Series	CPU	Link Module	COMM Type	Parameter	Cable
S7-200	CPU222 CPU224 CPU226	RS485 on the CPU unit	RS232	Setting	Your owner cable
	CPU224 XP CN CPU226 XP CN		RS485-2	Setting	Your owner cable
S7-300	CPU312IFM CPU313 CPU313C CPU314 CPU314IFM CPU315	MPI port on the CPU unit	RS232 S7-300/400 (PC Adapter)	Setting	Your owner cable
	CPU315-2 DP CPU316 CPU316-2 DP CPU318-2		RS485 S7-300/400 (via MPI port)	Setting	Your owner cable

Ethernet System configuration

Series	CPU	Link Module	Connect Type	Parameter	Cable
SIMATIC S7-200	CPU222 CPU224 CPU224 XP CPU226	CP 243-1 IT CP 243-1	Ethernet	Setting	Your owner cable

Serial Communication Setting

S7-200 default communication: 9600, 8, 1, even; station No.: 2.

1. HMI Baudrate can reach to 187.5k, but don't support online simulate for 187.5K.

RS232 communication

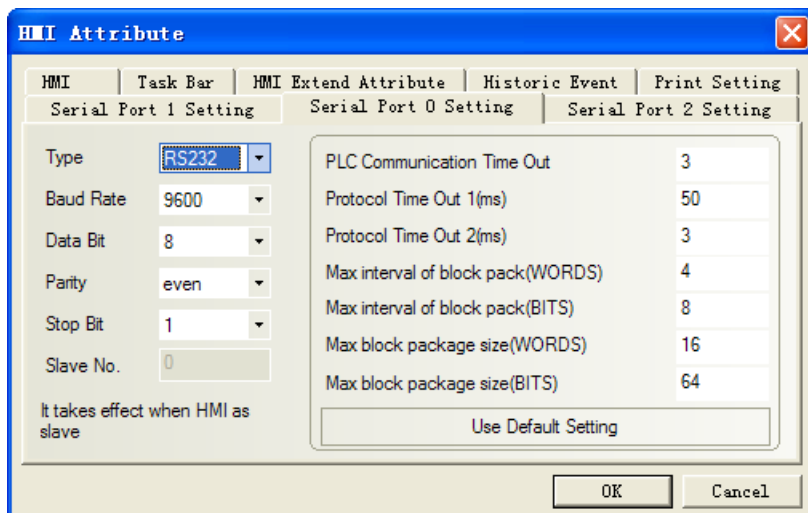

RS485 communication

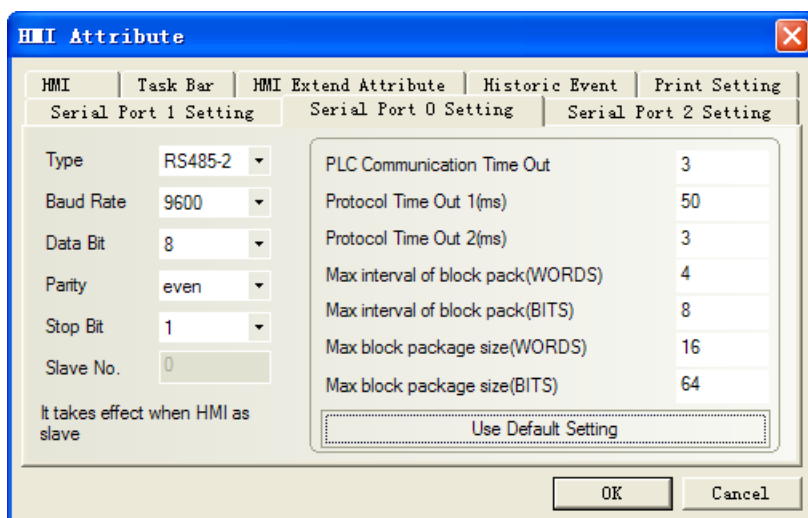

Siemens S7-300/400 (PC Adapter) driver protocol

1. If you use adapter to communicate, PLC must be 187.5K.
2. HMI communication setting: 19200, 8, 2, odd; station No.: 2
3. If we use PC adapter, PLC station No. is not necessary, so the communication is one-to-one.
4. You must set DB first, or register can not write (DB.DBX, DB.DBW, DB.DBD) . The initial address of DBm.DBW and DBm.DBD must be even.

RS232 communication

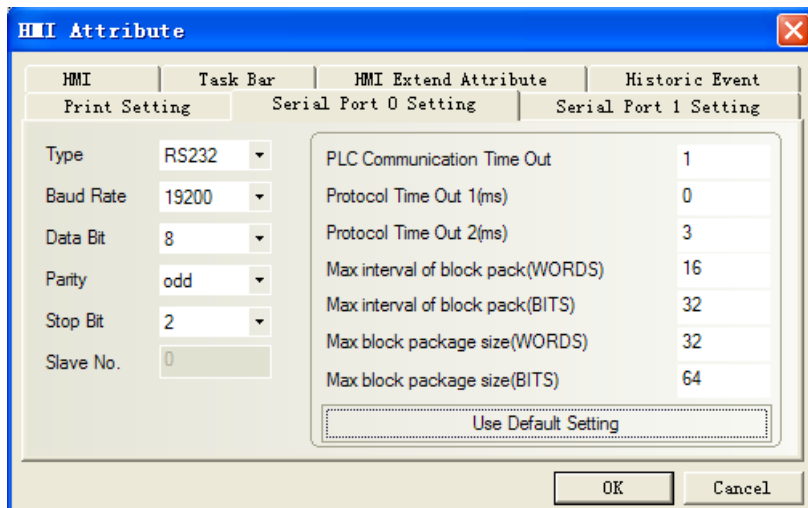

Siemens S7-300/400 (via MPI port) driver protocol

1. This drive only comport the HMI with MPI port. Don't support indirect online and direct online simulation.
2. MPI is RS485 port, so we can use this drive to communicate between many HMI and PLC, and then we must set the master station No..
3. HMI station No. can be 0~15, PLC station No. must be 0~15, the station No. of HMI and PLC can not be the same number.
4. PLC baud rate is 187500.
5. You must set DB first, or register can not write (DB.DBX, DB.DBW, DB.DBD) . The initial address of DBm.DBW and DBm.DBD must be even.
6. T/C register must be readonly.

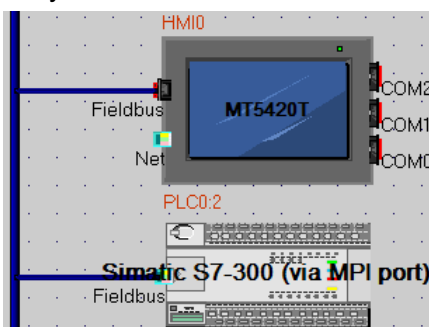

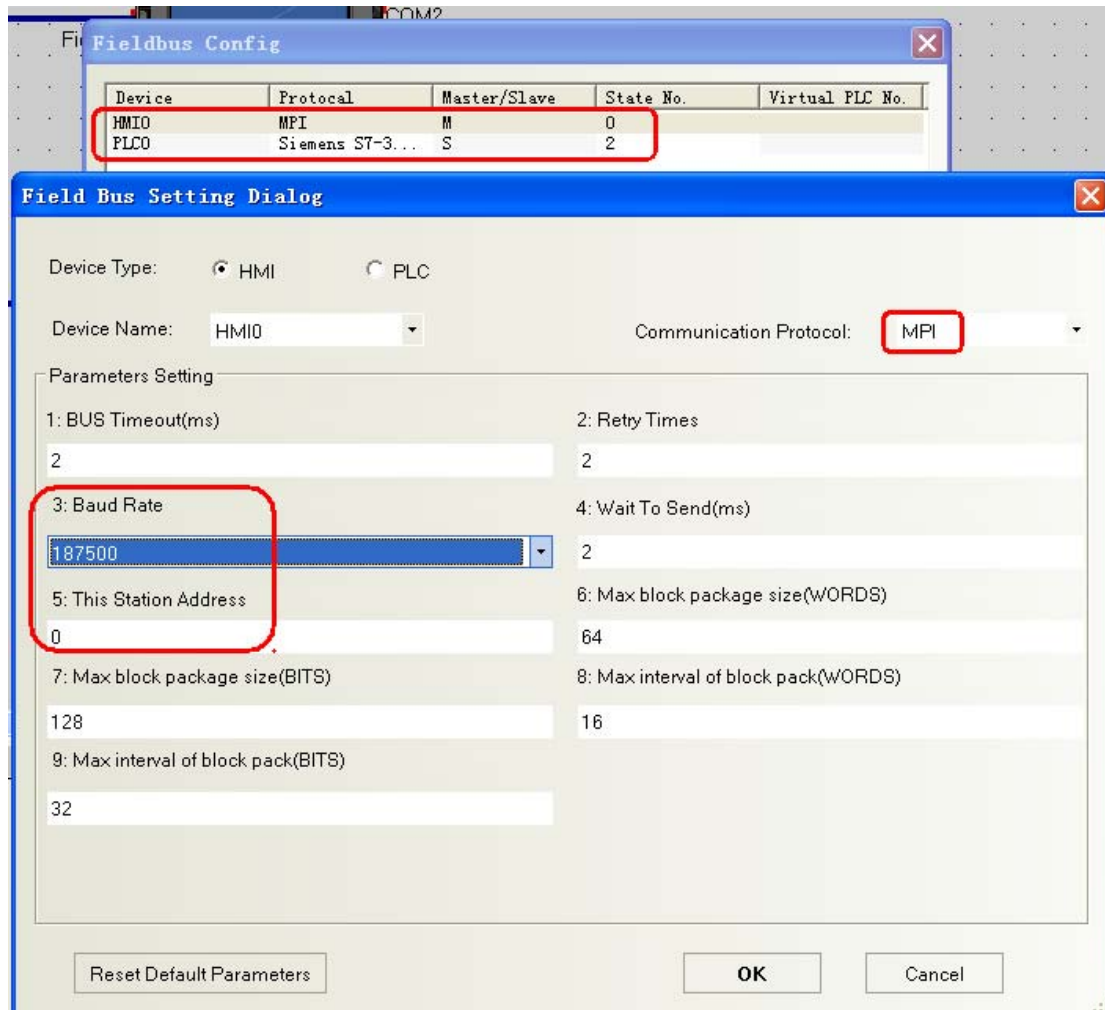

PLC software setting

S7-200 software setting

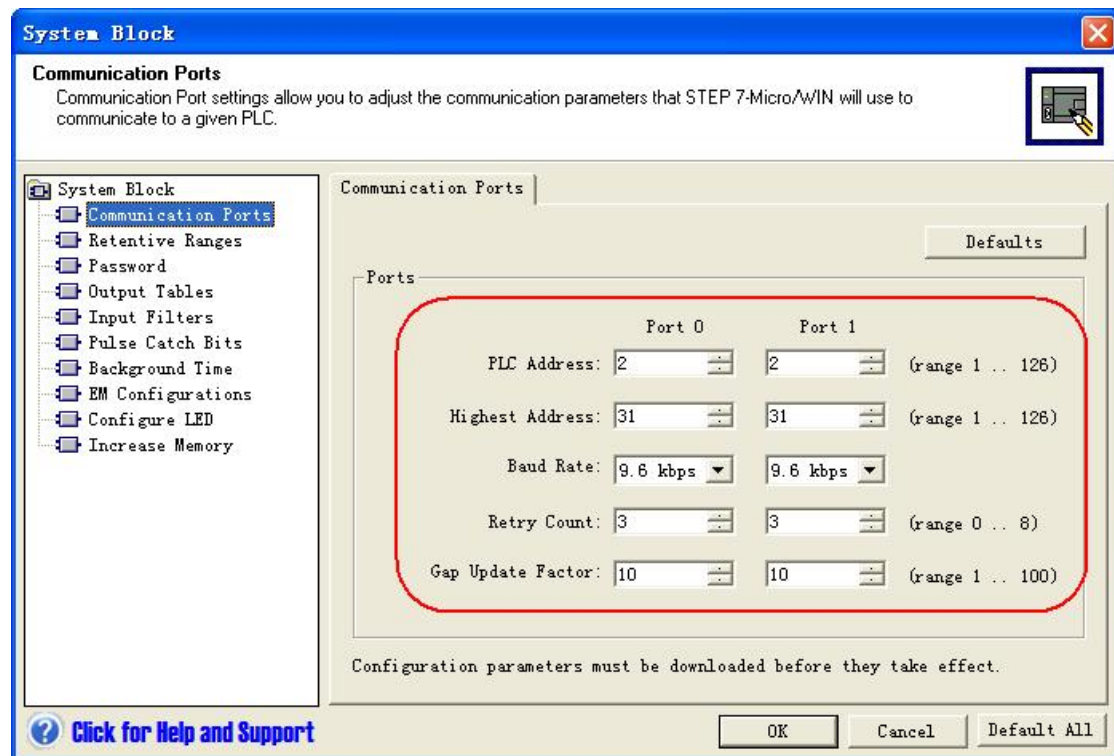

Siemens S7-300/400 (PC Adapter) drive software setting

A) Use adapter from eview corporation. MPI transmission rate must be set 187.5k. If the MPI transmission rate is 19.2k, you must change the rate to 187.5k via Siemens adapter (at the hardware attribute):

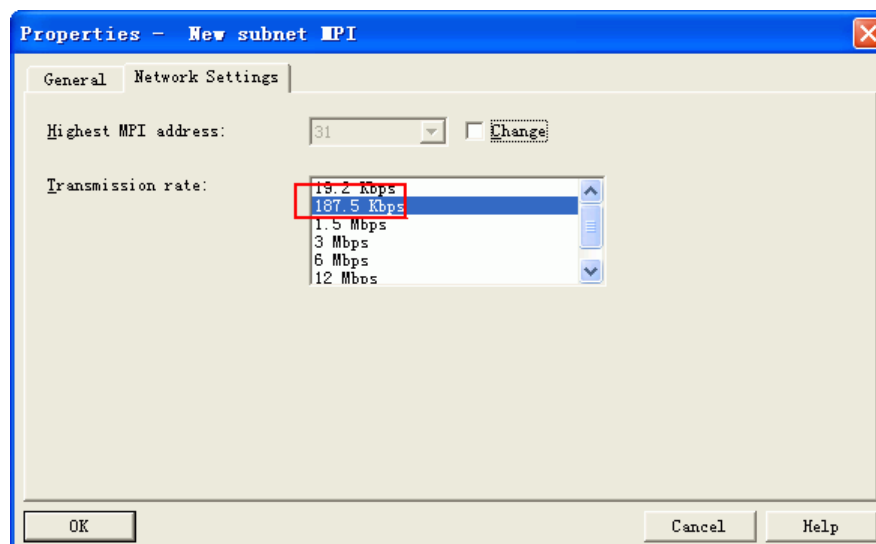

B) MPI address must be 2.

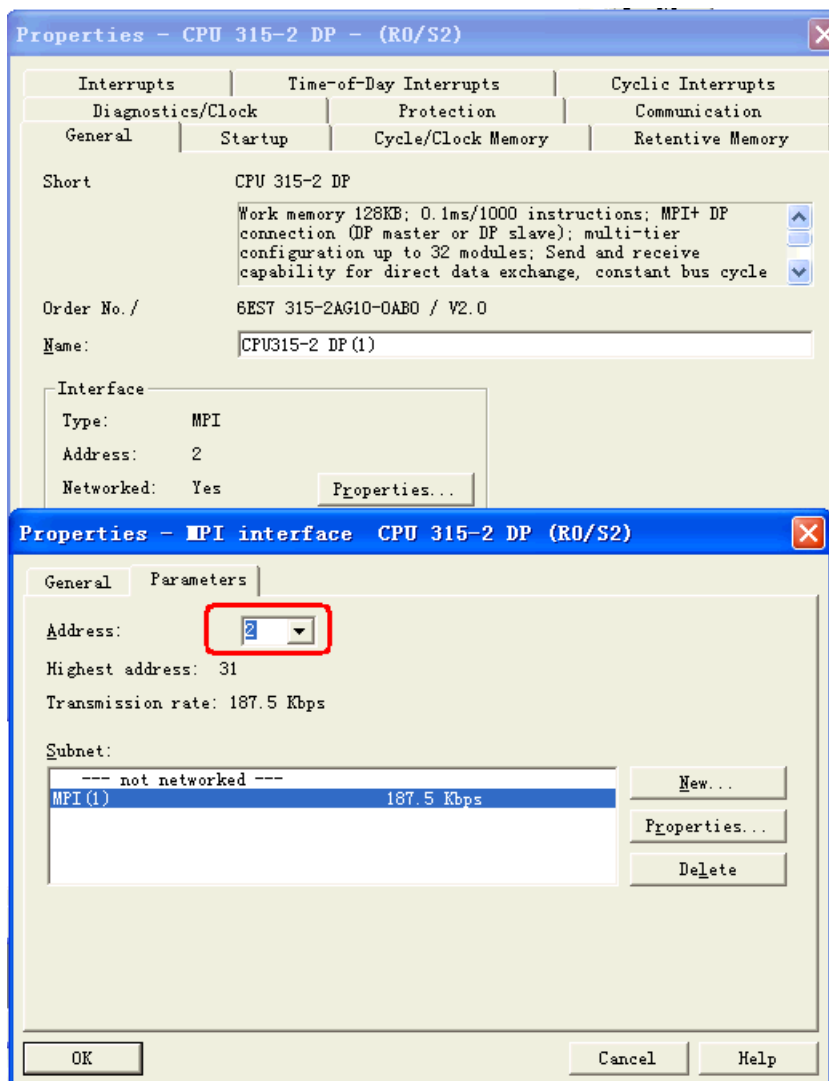

C) After Setting, download project into PLC. Make sure the MPI port's transmission rate is 187.5k, and select" PC Adapter(MPI)" in "set PG/PC interface" menu, change the transmission rate to 187.5k, as follows:

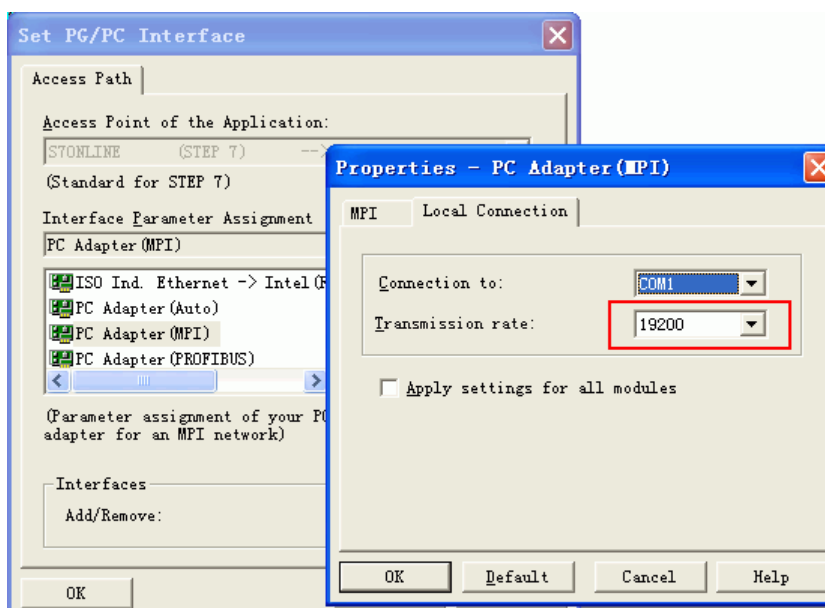

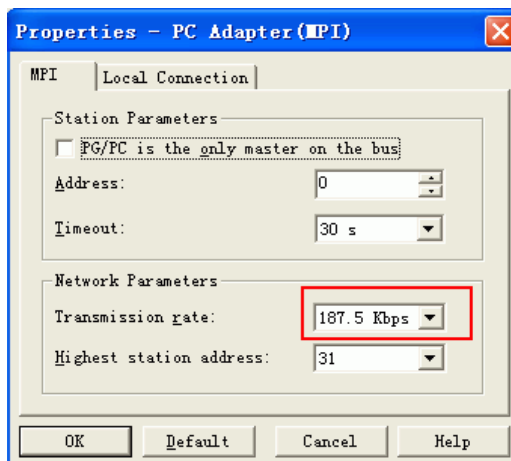

Siemens S7-300/400 (via MPI port) drive software setting

1. PLC station No. can be 0~15.
2. MPI baud rate can be 19.2k or 187.5k.

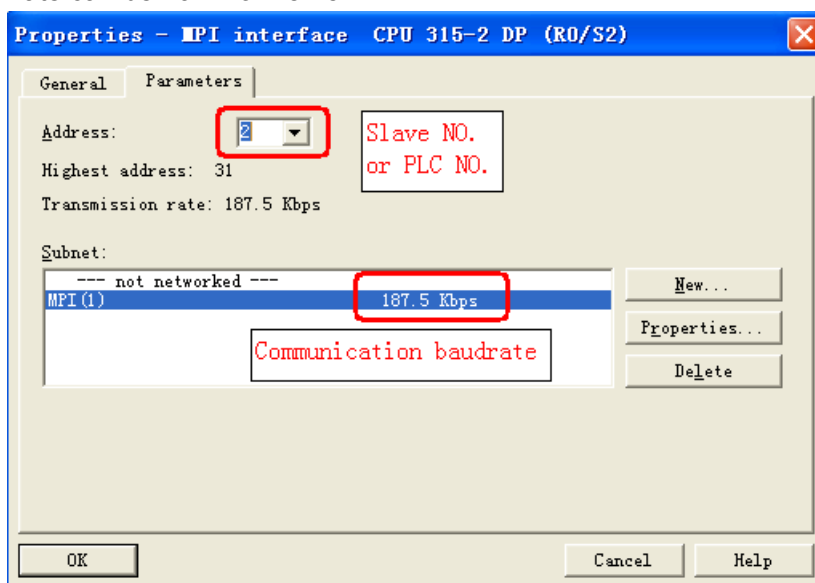

Ethernet Communication Setting

HMI

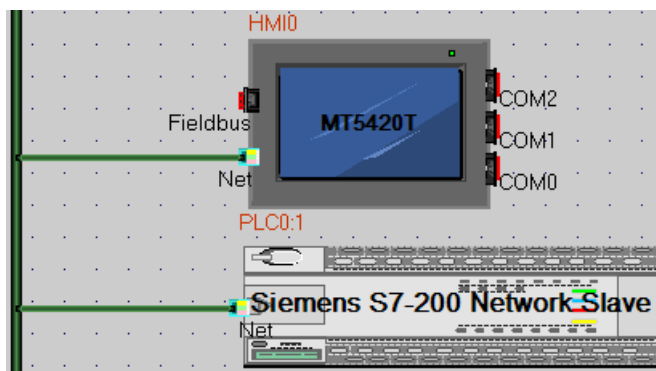

Network configuration

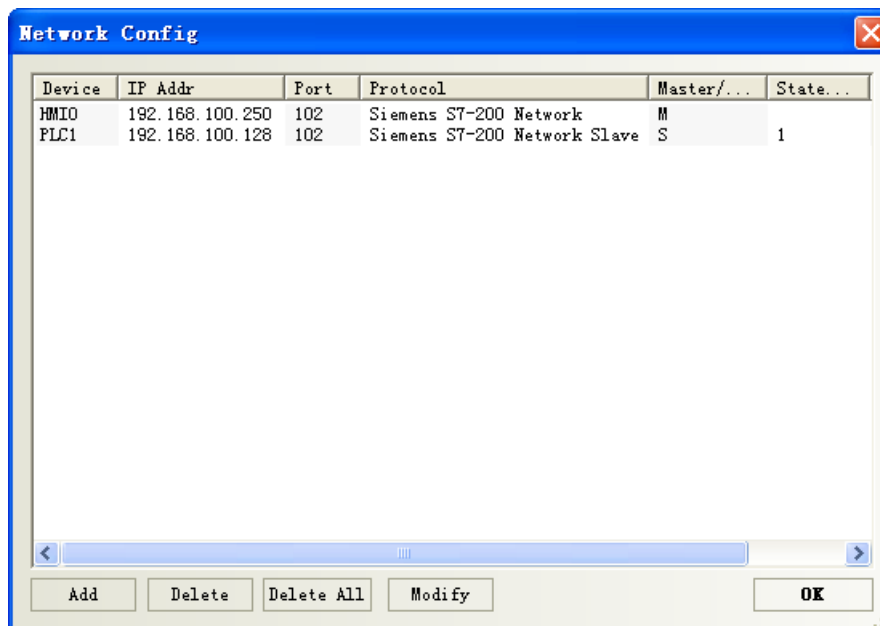

PLC configuration

The settings for the CP 243-1 are defined in STEP 7 Micro/WIN via the Ethernet Wizard. For assistance with all the information go to STEP 7 Micro/WIN Online Help via F1.

1. Starting the Ethernet Wizard

- Open STEP 7 Micro/WIN
- Start the Ethernet Wizard via “Tools >Ethernet Wizard...”
- Click on “Next”

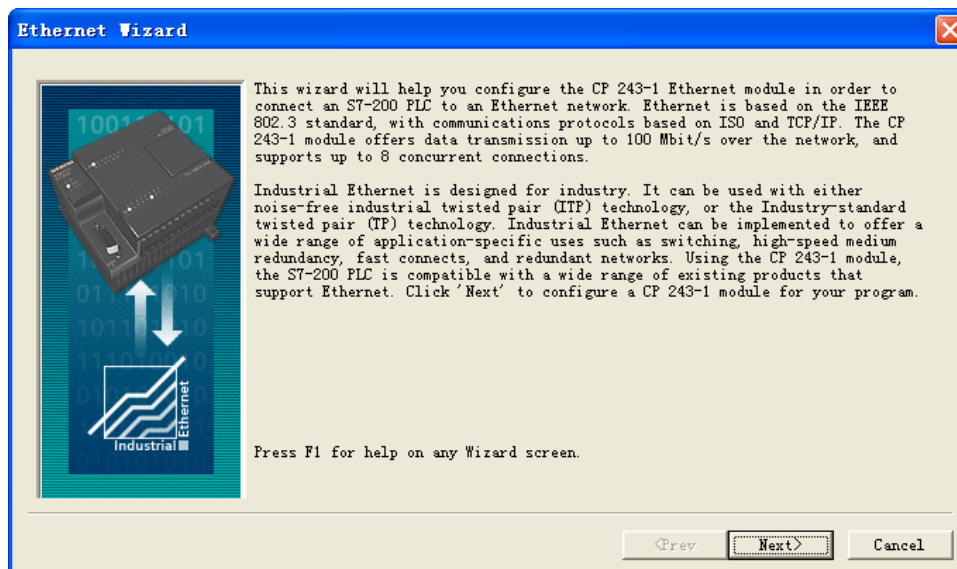

2. Specifying module position

If your PC is connected to the S7-200, click the “**Read modules**” button to determine the position of the CP 243-1 module automatically. Otherwise, the module position can also be entered manually.

Important:

The panel can only establish a connection with a Cp243-1 if the module is configured to “position 0”.

- Check if the CP is connected in the module position “ZERO” and change the module position if necessary.

- Identify or enter the module position “ZERO”.
- Click on “Next”.

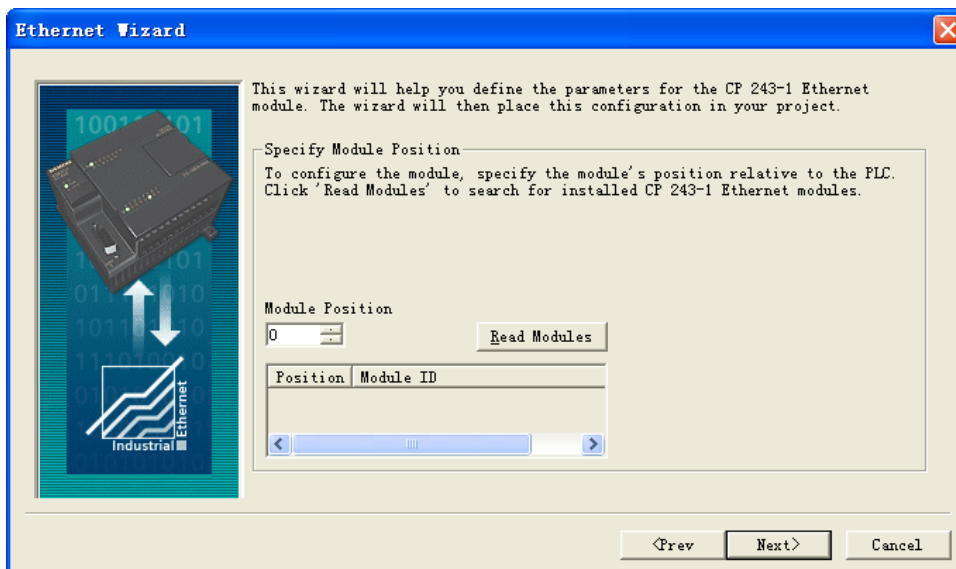

3. Specifying IP address

- Define an IP address for the CP 243-1.

Caution: The IP address for this application may not be taken automatically from a server because the panel requires a fixed reference partner (CP 243-1) for the Ethernet communication.

Note: The communication connection type for this module can be defined by the “Automatic Setting”.

- Click on “Next” to continue.

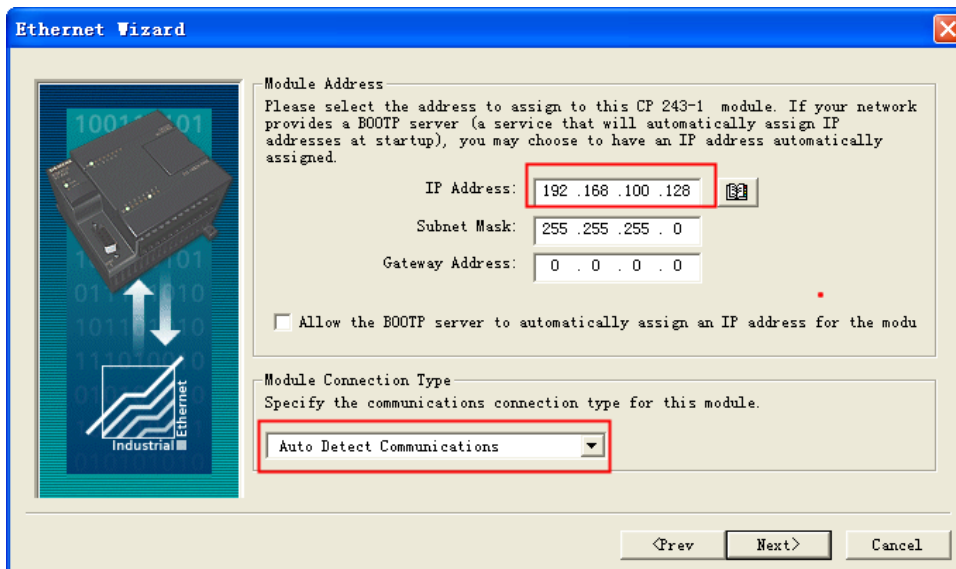

4. Parameterizing PtP connection

- Specify the command byte for the module and the number of point-to-point connections with the CP 243-1.
- Click on “Next”.

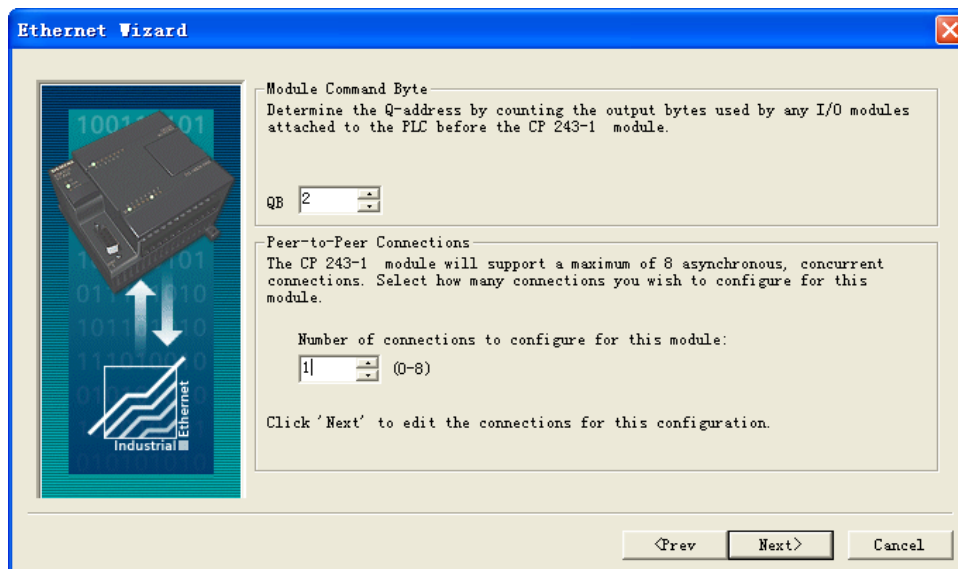

5. Configuration connection

- The configuration for connecting the CP 243-1 to the panel must be defined as in Fig..
- Click OK to confirm the entries.

Warning: The TSAP must always be specified in four-digit format, with a leading zero (02.00).

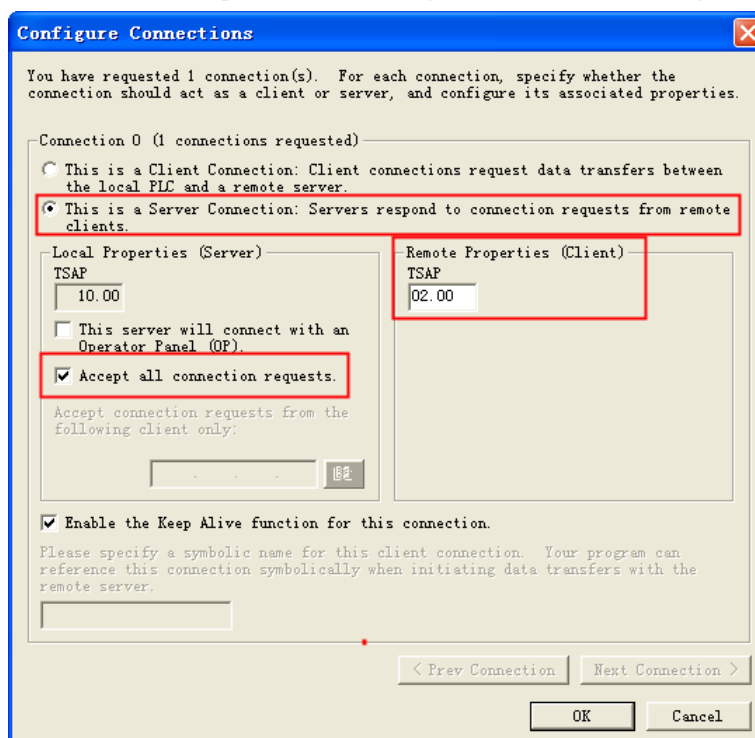

6. Using CRC protection

Set the CRC protection the way you want it. It is advisable to work without CRC protection first of all. The “Keep Alive Interval” can be specified with the default time.

- Activate the CRC protection and change the time of the “Keep Alive Interval” if required.
- Click on “Next”.

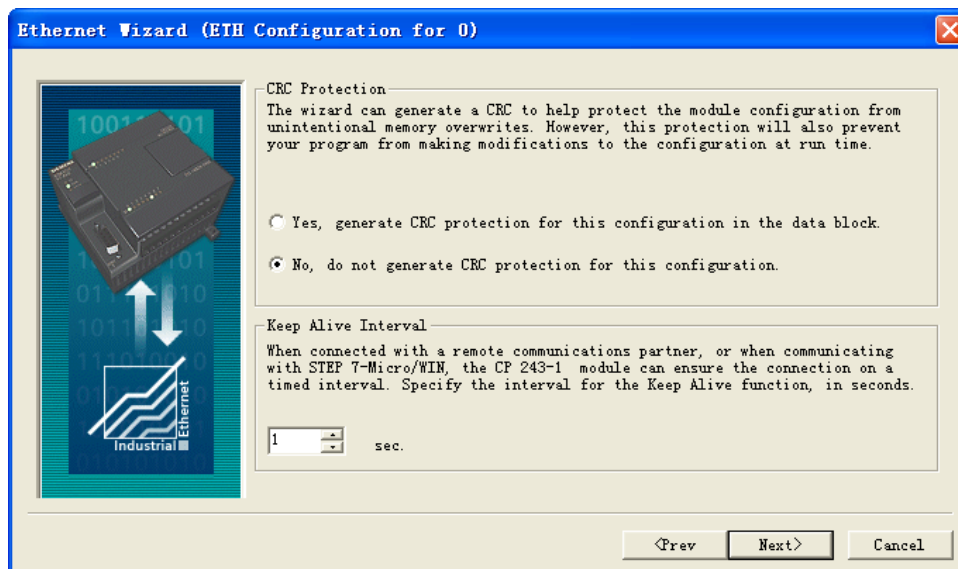

7. Assigning memory

- Specify a memory area for the configuration of the CP 243-1.

Recommend: If you click on **Suggest address**, the Wizard can identify a variable memory area.

Note: The register used in the panel must be out of the memory area for the configuration.

- Click on “Next”.

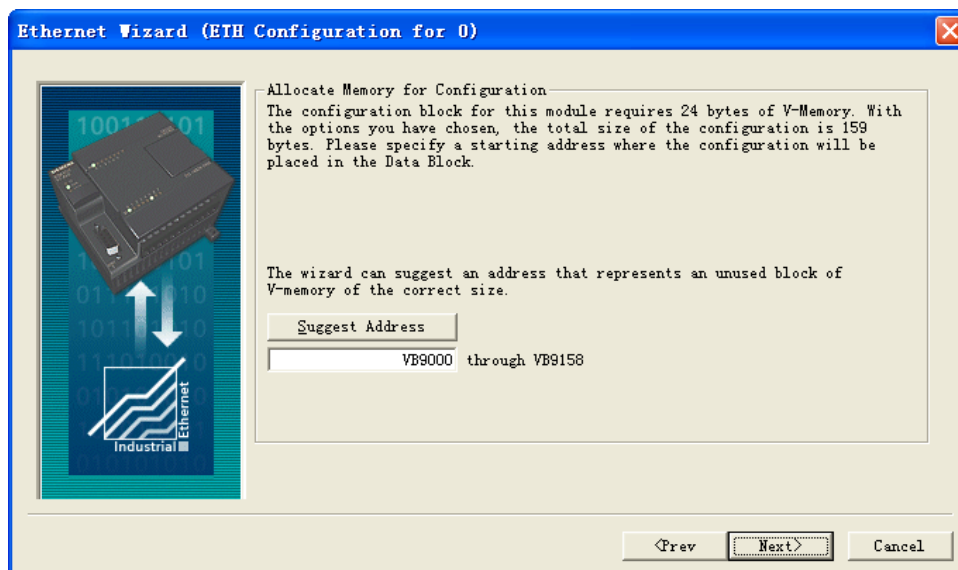

8. Creating project components

If you click on “Close”, the Ethernet Wizard generates the project components for the set configuration. Among other things, subprograms and the variable memory are created in the data block.

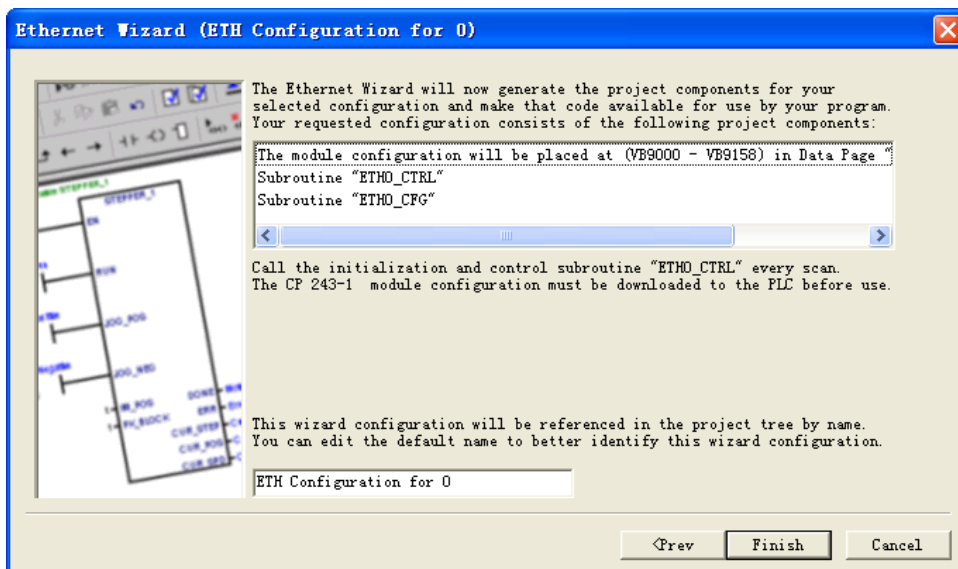

9. Confirm message

- Click “Yes” to confirm the message that appears.



10. Call ETHO_CTRL

- In your STEP 7 Micro/WIN program, you must call the ETHO_CTRL subroutine in each cycle.
- Finally, load the entire configuration into the S7-200.

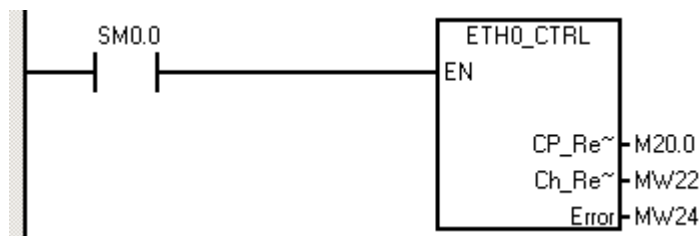

Supported Device

S7-200

Device	Bit Address	Word Address	Format
SCR	S.B0.0-255.7	-----	DDD.O
Special memory Relay	SM.B0-4399.7	-----	DDDD.O
Counter Relay	Cnt0-255	-----	DDD.O
Timer Relay	Tim0-255	-----	DDD.O
V Relay	V.B0.0-32768.7	-----	DDDDD.O
Internal Memory Relay	M.B0.0-32768.7	-----	DDDDD.O
Discrete outputs and image Relay	Q.B0.0-32768.7	-----	DDDDD.O

Discrete inputs and image Relay	I.B.0-32768.7	-----	DDDDD.O
Analog Outputs	-----	AQW0-62	DD
Analog Inputs	-----	AIW0-62	DD
SCR double word	-----	SD0-28	DD
SCR	-----	SW0-30	DD
Special memory double word	-----	SMD0-546	DDD
Special memory	-----	SMW0-548	DDD
Internal memory double word	-----	MD0-28	DD
Internal memory	-----	MW0-30	DD
Discrete outputs and image register double word	-----	QD0-12	DD
Discrete outputs and image register	-----	QW0-14	DD
Discrete inputs and image register double word	-----	ID0-12	DD
Discrete inputs and image register	-----	IW0-14	DD
Timer (Current Value)	-----	Cnt0-255	DDD
Counter (Current Value)	-----	Tim0-255	DDD
V memory double word	-----	VD0-10238	DDDDD
V memory	-----	VW0-10238	DDDDD

Note: VW、VD address must be an even number

S7-200 ethernet communication protocol

Device	Bit Address	Word Address	Format	Notes
V Relay	V.B 0.0-8191.7	-----	DDDD.O	
Internal Memory Relay	M.B 0.0-31.7	-----	DD.O	
Discrete outputs and image Relay	Q.B 0.0-15.7	-----	DD.O	
Discrete inputs and image Relay	I.B 0.0-15.7	-----	DD.O	
Internal memory double word	-----	MD 0-28	DD	
Internal memory	-----	MW 0-30	DD	
Discrete outputs and image register double word	-----	QD 0-12	DD	
Discrete outputs and image register	-----	QW 0-14	DD	
Discrete inputs and image register double word	-----	ID 0-12	DD	
Discrete inputs and image register	-----	IW 0-14	DD	
V memory double word	-----	VD 0-8188	DDDD	
V memory	-----	VW 0-8190	DDDD	

Siemens S7-300/400 (PC Adapter) driver protocol

Device	Bit Address	Word Address	Format	Notes
External Input node	I 0.0~127.7	-----	DDDD.O	
External Output node	Q 0.0~127.7	-----	DDDD.O	

Internal assistant node	M 0.0~2047.7	-----	DDDD.O	
Data Register Relay node	DBm.DBX 0~8192.7	-----	DDDD.O	m 10-60
Data Register Relay	-----	DBm.DBW 0-8192	DDDDD	m 10-60
Data Register Relay (32 bit)	-----	DBm.DBD 0-8192	DDDDD	m 10-60
Internal Relay	-----	MW 0~2046	DDDD	
Internal Relay (32 bit)	-----	MD 0~2044	DDDD	
External Output Relay	-----	QW 0~126	DDD	
External Output Relay (32 bit)	-----	QD 0~124	DDD	
External Input Relay	-----	IW 0~126	DDD	
External Input Relay (32 bit)	-----	ID 0~124	DDD	

Siemens S7-300/400 (via MPI port) driver protocol

Device	Bit Address	Word Address	Format	Notes
External Input node	I 0.0~127.7	-----	DDDD.O	
External Output node	Q 0.0~127.7	-----	DDDD.O	
Internal assistant node	M 0.0~2047.7	-----	DDDD.O	
Data Register Relay node	DBm.DBX 0.0~65533.7	-----	DDDDD.O	m 1-60
Counter	-----	C 0~255	DDD	R
Timer	-----	T 0~255	DDD	
Internal Relay	-----	MW 0~2046	DDDD	
External Output Relay	-----	QW 0~126	DDD	
External Input Relay	-----	IW 0~126	DDD	
Data Register Relay	-----	DBm.DBW 0~65532	DDDDD	m 1-60
Data Register Relay (32 bit)	-----	DBm.DBD 0~65532	DDDDD	m 1-60

Cable Diagram

S7-200 series RS232 communication

Adapter cable by Eview Corporation direct connected with HMI is RS232 communication

S7-200 series RS485 communication

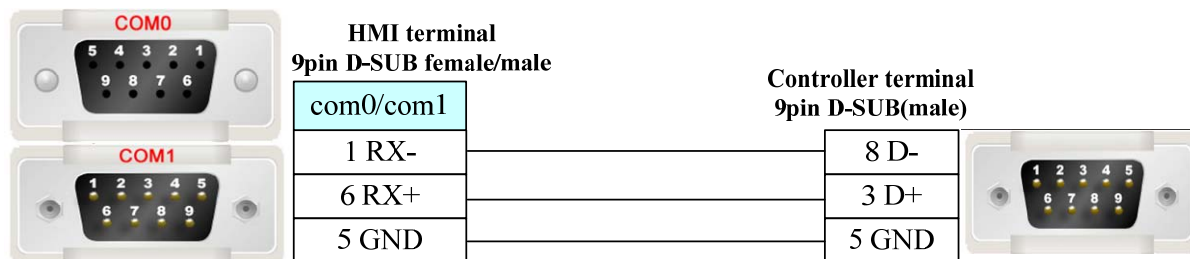

Siemens S7-300/400 (PC Adapter) RS232 communication

1. MPI cable by Siemens

Need to add a communication cable in adapter RS232 terminal

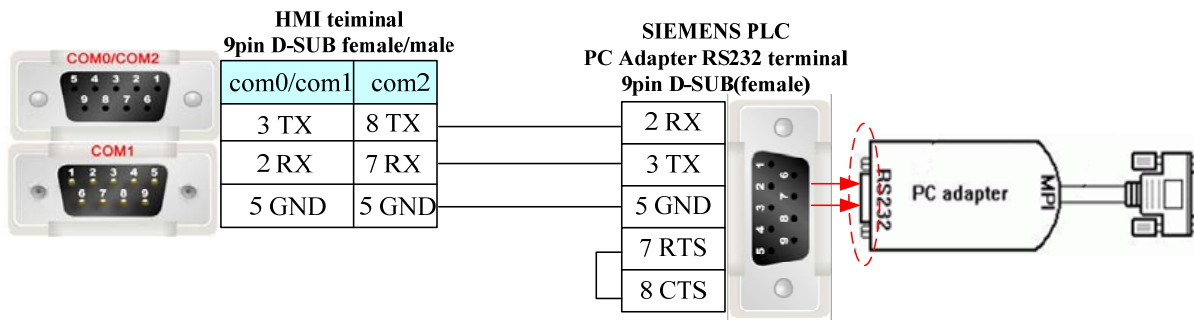

If the PC Adapter with the following RS232 cable, it must add a connection line for communicating with touch-screen

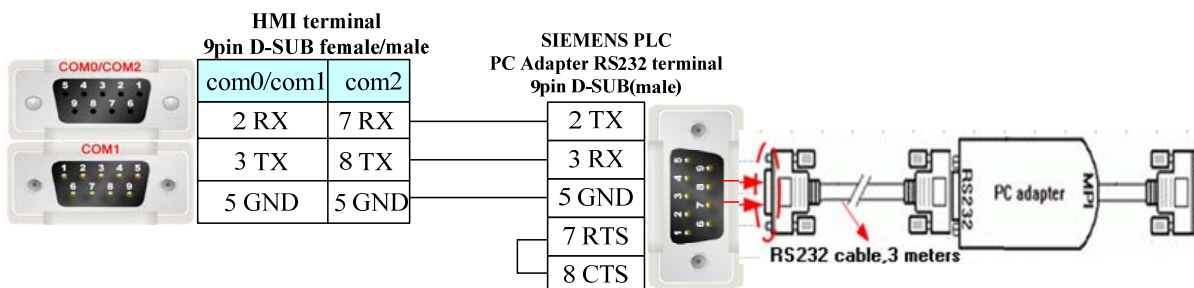

2. Long distance communication with MPI adapter:

Extend the RS485 port:

The cable length must be 600m or less in the 187.5k, the 7 pin and 2 pin must connect with 24v power in the port of RS485, the 8 pin and 3 pin must connect with 120 Ω terminal resistance.

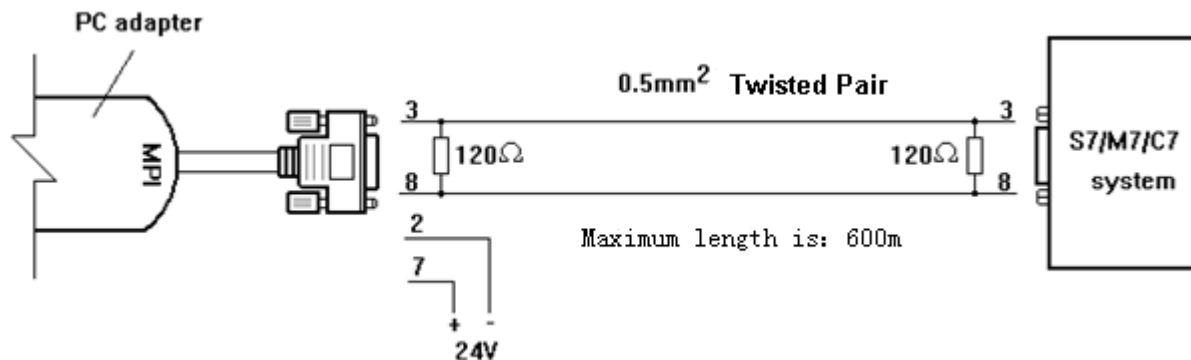

3. MPI MT5-S7-300 Adapter by Eview Corporation direct connected with HMI is RS232 communication

Siemens S7-300/400 (via MPI port) RS485 communication

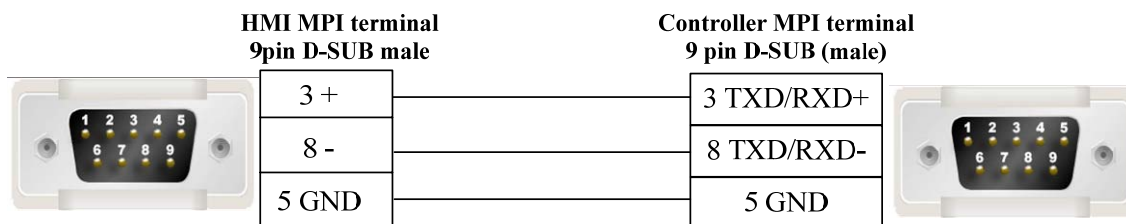

S7-200 Ethernet communication protocol cable

Connecting PC and HMI use cross-ruling; use Cross-over cable or cross-ruling via hub or switch.

a. cross-ruling cable diagram:

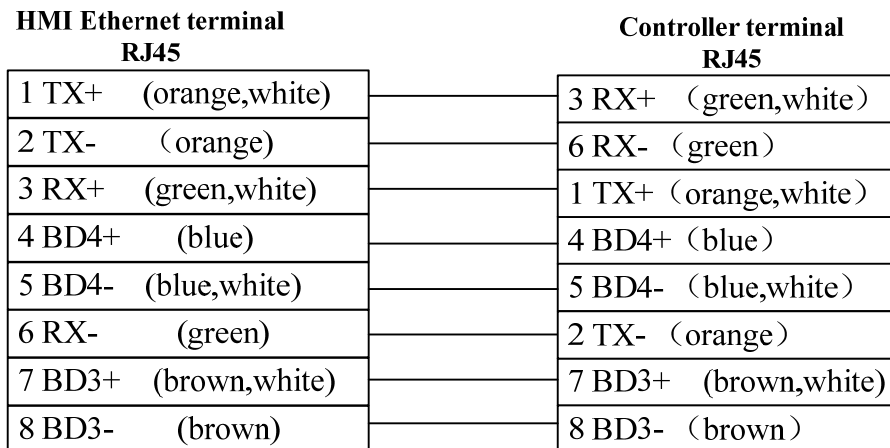

b. cross-over cable diagram:

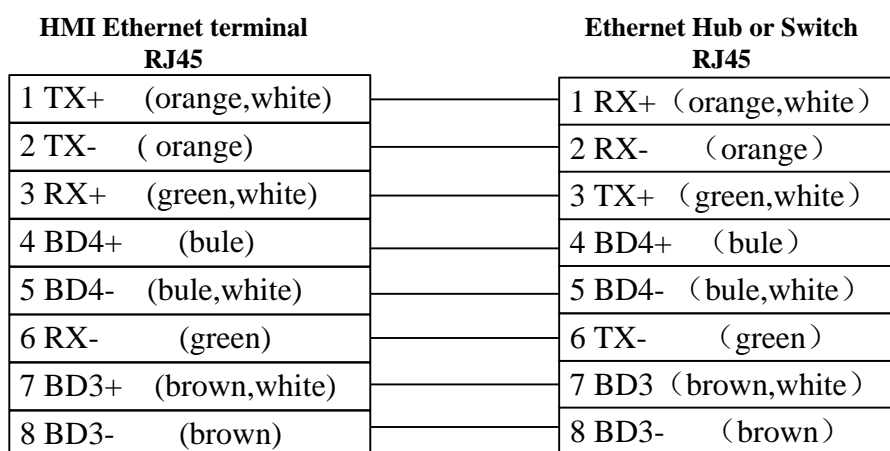

TAIAN

Serial Communication

Series	CPU	Link Module	Driver
Taian	TOP3-30HR-A	RS232 on the CPU unit	Taian
		RS485 on the CPU unit	

System configuration

Series	CPU	Link Module	COMM Type	Parameter	Cable
Taian	TOP3-30HR-A	RS232 on the CPU unit	RS232	Setting	Your owner cable
		RS485 on the CPU unit	RS485	Setting	Your owner cable

Communication Setting

Default communication: 19200, 8, none, 1; station: 1

RS232

The screenshot shows the 'HMI Attribute' dialog box with the 'Serial Port 0 Setting' tab selected. The 'Type' is set to 'RS232'. The 'Baud Rate' is '19200', 'Data Bit' is '8', 'Parity' is 'none', 'Stop Bit' is '1', and 'Slave No.' is '1'. The communication parameters table is as follows:

PLC Communication Time Out	1
Protocol Time Out 1(ms)	3
Protocol Time Out 2(ms)	3
Max interval of block pack(WORDS)	2
Max interval of block pack(BITS)	8
Max block package size(WORDS)	16
Max block package size(BITS)	64

Buttons: 'Use Default Setting', 'OK', 'Cancel'.

RS485

The screenshot shows the 'HMI Attribute' dialog box with the 'Serial Port 1 Setting' tab selected. The 'Type' is set to 'RS485-2'. The 'Baud Rate' is '19200', 'Data Bit' is '8', 'Parity' is 'none', 'Stop Bit' is '1', and 'Slave No.' is '1'. The communication parameters table is as follows:

PLC Communication Time Out	1
Protocol Time Out 1(ms)	3
Protocol Time Out 2(ms)	3
Max interval of block pack(WORDS)	2
Max interval of block pack(BITS)	8
Max block package size(WORDS)	16
Max block package size(BITS)	64

Buttons: 'Use Default Setting', 'OK', 'Cancel'. Note: 'It takes effect when HMI as slave'.

Supported Device

Device	Bit Address	Word Address	Format
Input Relay (receive external switch signal)	X0-377	-----	OOO
Output Relay	Y0-377	-----	OOO
Auxiliary Relay	M (0-7679) & (8000-8511)	-----	DDDD
Step Relay	S0-4096	-----	DDDD
Timer Relay	T0-511	-----	DDD
Counter Relay	C0-255	-----	DDD
Data Register	-----	D0-8511	DDDD
Data Register	-----	Z0-15	DD
Data Register	-----	V0-15	DD
Timer(Current value)	-----	T_Current_Word 0-511	DDD

Counter(Current value)	-----	C_Current_Word 0-199	DDD
Counter	-----	C_Current_Double 200-255	DDD
Timer(Preset value)	-----	T_Preset_Word 0-511	DDD
Counter(Preset value)	-----	C_Preset_Word 0-199	DDD
Counter	-----	C_Preset_Double 200-255	DDD

Note:

Z, V is the turn of the write and read out. When testing a single word, max interval of word block pack and max word block package size are changed to 1.

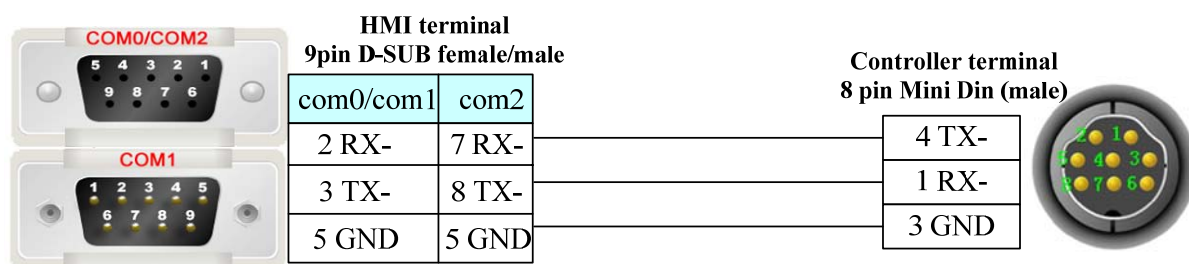
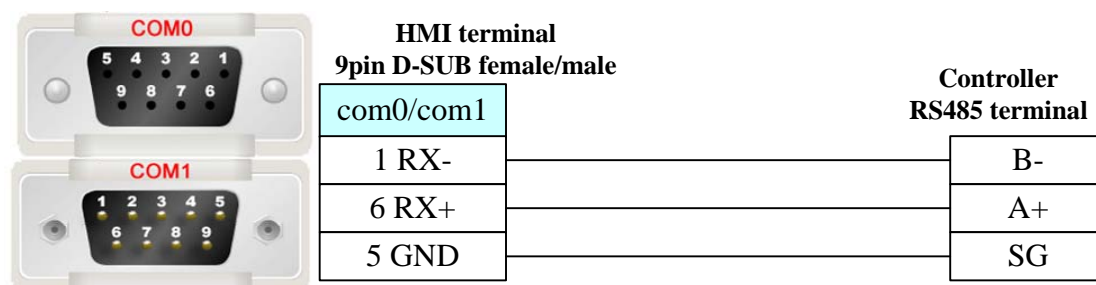
Cable Diagram**TOP3-30HR-A RS232 communication cable****TOP3-30HR-A RS485 communication cable****TMCM_303****Serial Communication**

Series	CPU	Link Module	Driver
TMCM_303		RS232 on the CPU unit	TMCM_303

System configuration

Series	CPU	Link Module	COMM Type	Parameter	Cable
TMCM_303		RS232 on the CPU unit	RS232	Setting	Your owner cable

Communication Setting

Default communication: 9600, 8, none, 1; station: 1

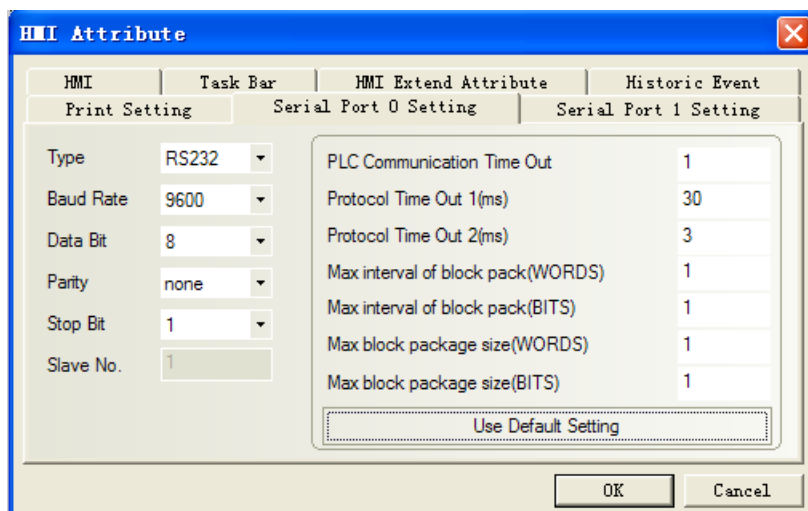

Supported Device

Please refer to TMCL Reference Manual for device details

TMCM_303

Device	Bit Address	Word Address	Format	Notes
ROR	-----	0-2	D	Write Only
ROL	-----	0-2	D	Write Only
MST	0-2	-----	D	Write Only
MVP	-----	0.0-2.7	DD.D	Write Only
SAP	0.008-0.013 1.008-1.013 2.008-2.013	0.0-2.213	DDDD.DDD	Write Only
GAP	0.008-0.013 1.008-1.013 2.008-2.013	0.0-2.213	DDDD.DDD	Read Only
STAP	0.0-2.213	-----	DDDD.DDD	Write Only
RSAP	0.0-2.213	-----	DDDD.DDD	Write Only
SGP	0.077 0.129	0.0-0.038 0.64-0.81 0.128-0.132 1.0-1.11 2.0-2.19	DDDD.DDD	Write Only
GGP	0.077 0.129	0.0-0.038 0.64-0.81 0.128-0.132 1.0-1.11	DDDD.DDD	Read Only

		2.0-2.19		
RFS	-----	DWord 0.0-2.2	DD.D	Write Only
SIO	0-7	-----	D	Write Only
GIO	0.0-0.10 2.0-2.07	1.0-1.7	DDD.DD	Read Only
CALC	-----	0-9	D	Write Only
COMP	-----	0	D	Write Only
JC	-----	0-9	DD	Write Only
JA	-----	0	D	Write Only
CSUB	-----	0	D	Write Only
RSUB	0	-----	D	Write Only
WAIT	-----	0.0-4.7	DD.D	Write Only
STOP	0	-----	D	Write Only

Cable Diagram

RS232 Communication Cable

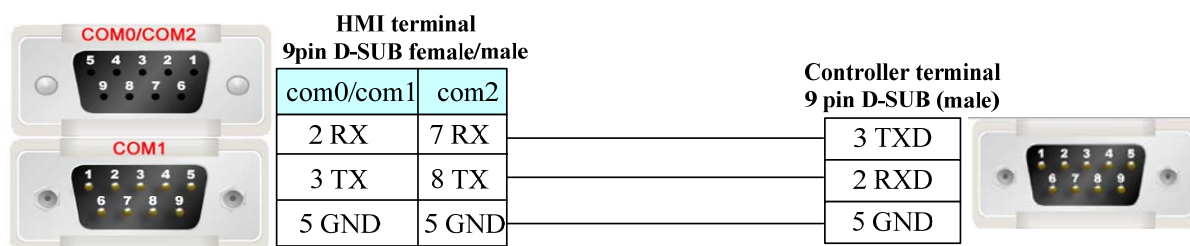

THINGET Controller (Support MODBUS RTU Protocol)

Serial Communication

Series	CPU	Link Module	Driver
THINGET XC	XC3-32R-E	RS232 on the CPU unit	MODBUS RTU/ THINGET Controller

System configuration

Series	Link Module	COM Type	Parameter	Cable
THINGET XC	RS232 on the CPU unit	RS232	Setting	Your owner cable

Communication Setting

Default communication: 19200, 8, even, 1; station: 1

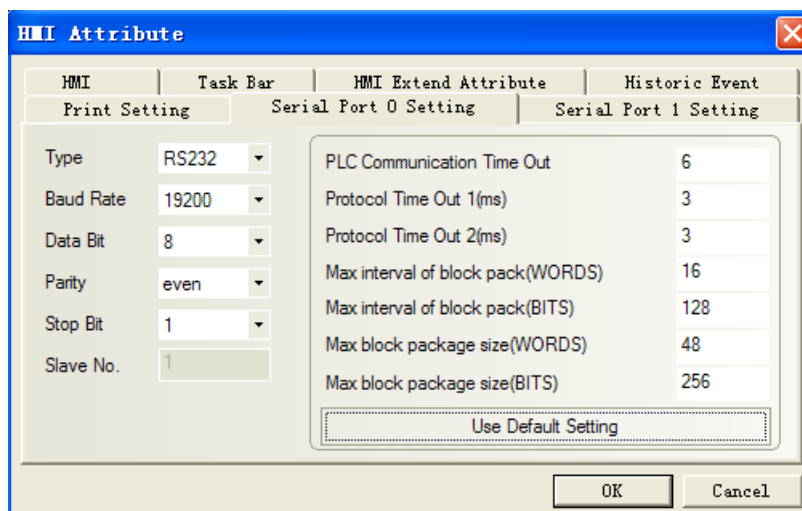

Supported Device

Device	Bit Address	Word Address	Format	Notes
Internal Relay	M0~M7999	-----	DDDDD	
Input Relay	X0.0~X51.1	-----	OOOOOO.O	
Output Relay	Y0.0~Y51.1	-----	OOOOOO.O	
State Relay	S0~S1023	-----	DDDDD	
Special Relay	M8000~M8511	-----	DDDDD	
Timer Relay	T0~T618	-----	DDDDD	
Counter Relay	C0~C634	-----	DDDDD	
Data register	-----	D0~D7999	DDDDD	
Timer	-----	TD0~TD618	DDDDD	
Counter	-----	CD0~CD634	DDDDD	
Special Data Register	-----	D8000~D8511	DDDDD	
FlashROM Register	-----	FD0~FD5000	DDDDD	
Special FlashROM Register	-----	FD8000~FD8511	DDDDD	

Note:

1. **O** indicates **OCT**, **D** indicates **HEX**.
2. Example: X\Y address: 1 in the controller corresponds with 0.1 in the ev5000;
X\Y address: 17 in the controller correspond with 1.7 in the ev5000.

MODBUS RTU protocol

Register address in programmable controller correspond with address in modbus protocol, as follows:

Coil Area:

bits Addr	MODBUS addr (Decimal K)
M0~M7999	0X1~0X8000
X0~X511	0X16385~0X16714

Y0~Y511	0X18433~0X 18762
S0~S1023	0X20481~0X21504
M8000~M8511	0X24577~0X25088
T0~T618	0X25601~0X26219
C0~C634	0X27649~0X28283

Register Area:

words Addr	MODBUS addr (Decimal K)
D0~D7999	4X1~4X8000
TD0~TD618	4X12289~4X12907
CD0~CD634	4X14337~4X 14971
D8000~D8511	4X16385~4X 16896
FD0~FD1535	4X18433~4X19968
FD8000~FD8511	4X26625~4X 27136

Cable Diagram

XC3-32R-E RS232 Communication

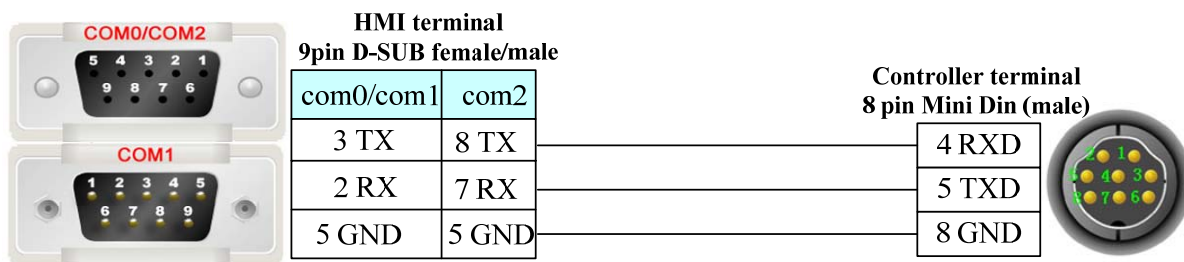

XC3-32R-E RS485 Communication

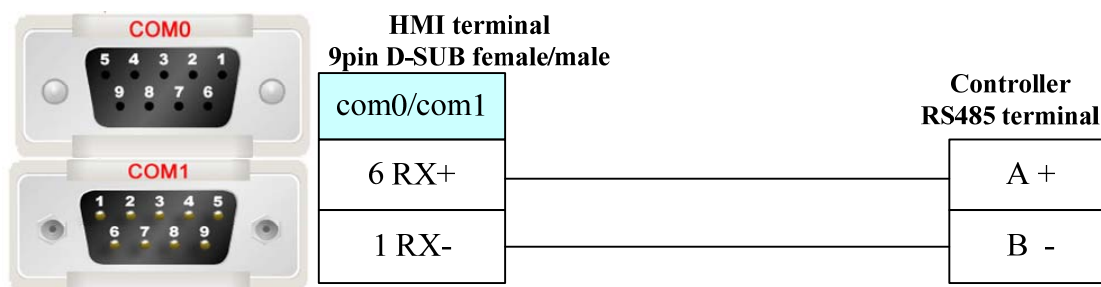

Note: A/B pin is on the output port.

Trio motion controller

Serial Communication

Series	CPU	Link Module	Driver
--------	-----	-------------	--------

Euro	Euro 205x	RS232 on the CPU unit	TRIO
			Modbus RTU Extend

System configuration

Series	CPU	Link Module	COMM Type	Parameter	Cable
TRIO	Euro 205x	RS232 on the CPU unit	RS232	Setting	Your owner cable
		RS485 on the CPU unit	RS485-4	Setting	Your owner cable
Modbus RTU Extend	Euro 205x	RS232 on the CPU unit	RS232	Setting	Your owner cable
		RS485 on the CPU unit	RS485-4	Setting	Your owner cable

Communication Setting

Omron Protocol default communication: 9600, 7, even, 2; station: 1
RS232 communication

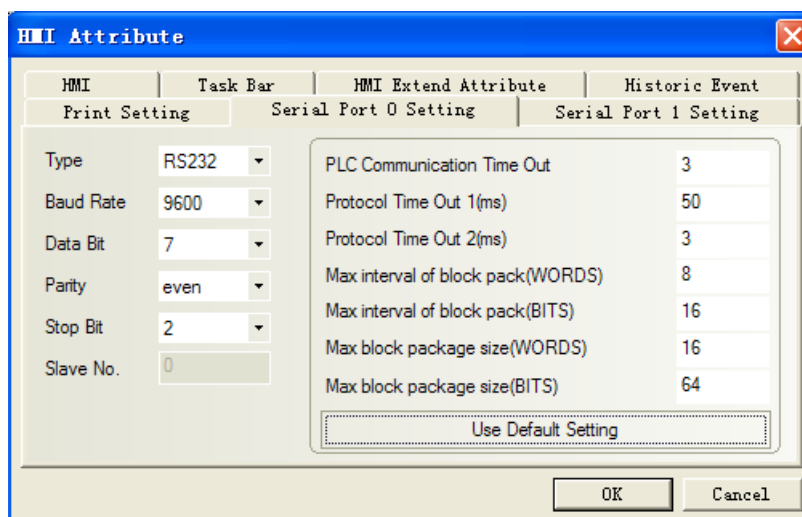

Controller internal setting:

```
HLS_NODE=1
HLS_MODEL=$FA
SETCOM(9600,7,2,2,1,5)
```

RS485-4 communication

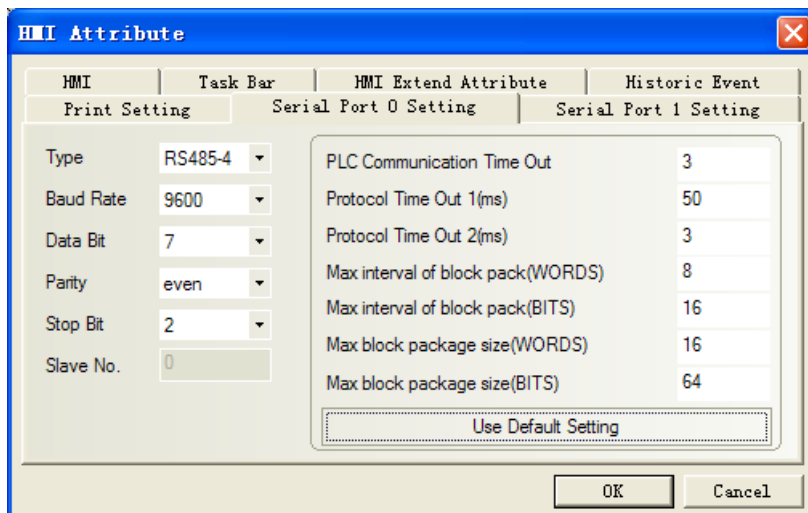

Controller internal setting:

```
HLS_NODE=1
HLS_MODEL=$FA
SETCOM(9600, 7, 2, 2, 2, 5)
```

Modbus protocol default communication: 9600, 8, even, 1; station: 1
RS232 communication

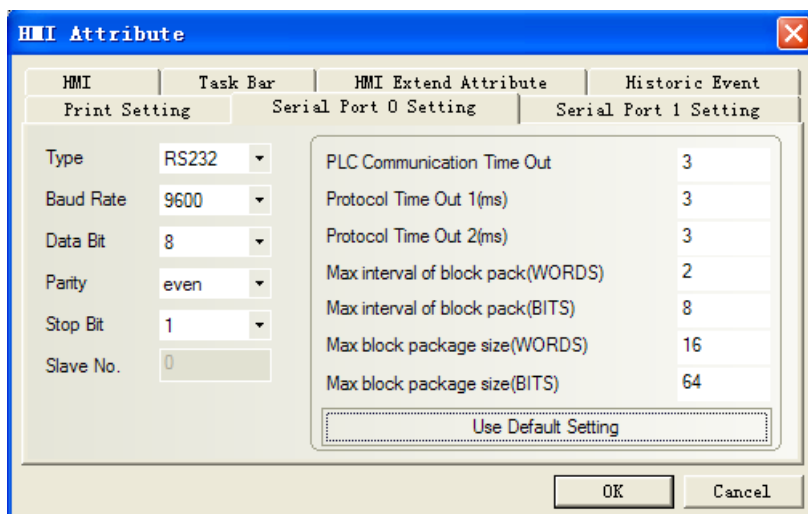

RS485-4 communication

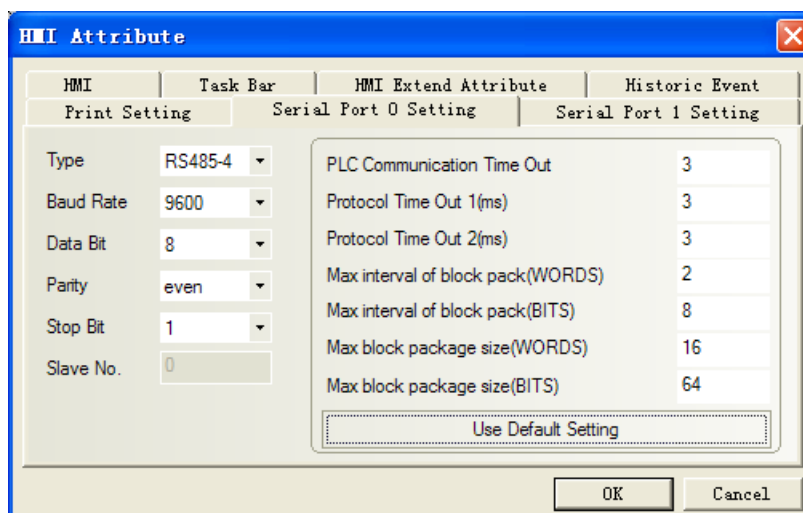

Trio controller communication settings

Omron protocol:

define Host Link slave node

HLS_NODE=1

define Host Link slave mode code

HLS_MODEL=\$FA

Set up Host Link slave for port 2

Trio controller setting: SETCOM (baudrate, databits, stopbits, parity, port, 5)

SETCOM (9600, 7, 2, 2, 2, 5)

MC controller unit can communicate with plc terminal after setting the configuration.

Note: A is the programming port of controller, B is the communication port.

Modbus Protocol:

address=1

Setcom (9600, 8, 1, 0, 1, 4)

Supported Device

TRIO

Device	Bit Address	Word Address	Format	Notes
I/O and Internal Auxiliary Relay	IR0.0-1023.15	————	DDDD.DD	
Data Memory	————	DM0-30000	DDDDD	

Note:

Address correspondence: IRn.m-->the m Trio VR (n); DMn->Table (n). Example IR1.02 corresponds to the 2nd bit of VR1.

Modbus RTU Extend

Device	Bit Address	Word Address	Format	Notes
Data register bit	4X_bit 0.0-1023.15	————	DDDD.DD	

Data register	—————	4X 0-1023	DDDDD	
---------------	-------	-----------	-------	--

Note:

Address correspondence: 4x corresponds to VR; 4x_bit corresponds to VR's bit. Address difference between one position, e.g. 4x (501) corresponds to VR (500); 4x_bit (67.1) corresponds to the first bit of VR (66).

Cable Diagram

Programming Cable

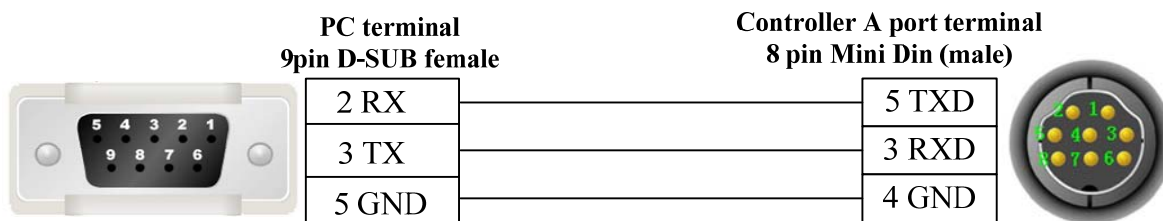

RS232 Communication Cable

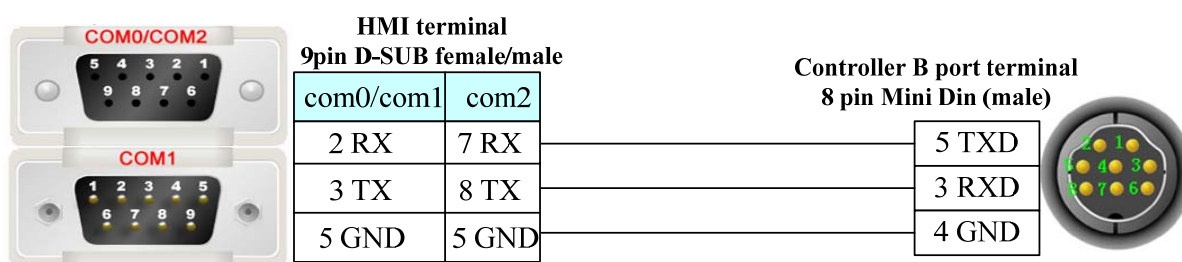

RS422 Communication Cable

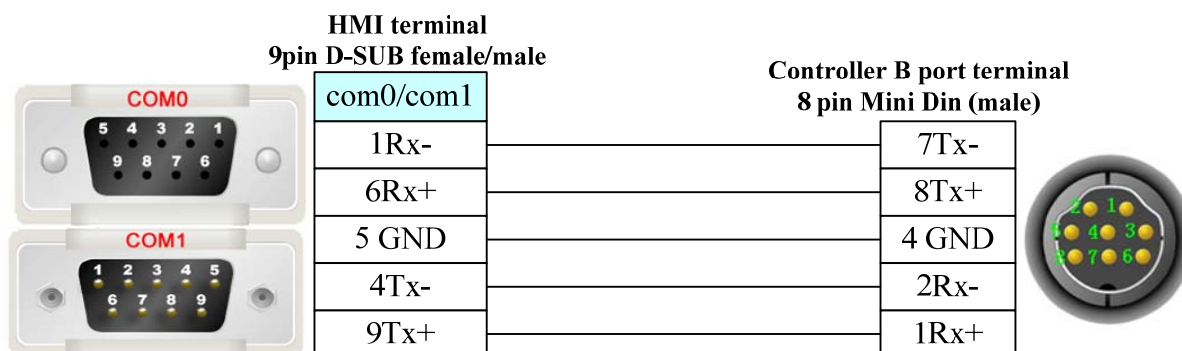

Vigor Corporation

Serial Communication

Series	CPU	Link Module	Driver
VH	VH-14MR	RS232 on the CPU unit	Vigor
VB0	VB0-14MR	RS232 on the CPU unit	

System configuration

Series	CPU	Link Module	COMM Type	Parameter	Cable
VH	VH-14MR	RS232 on the CPU unit	RS232	Setting	Your owner cable
VB0	VB0-14MR	RS232 on the CPU unit	RS232	Setting	Your owner cable

Communication Setting

Default communication: 19200, 7, even, 1; station: 0

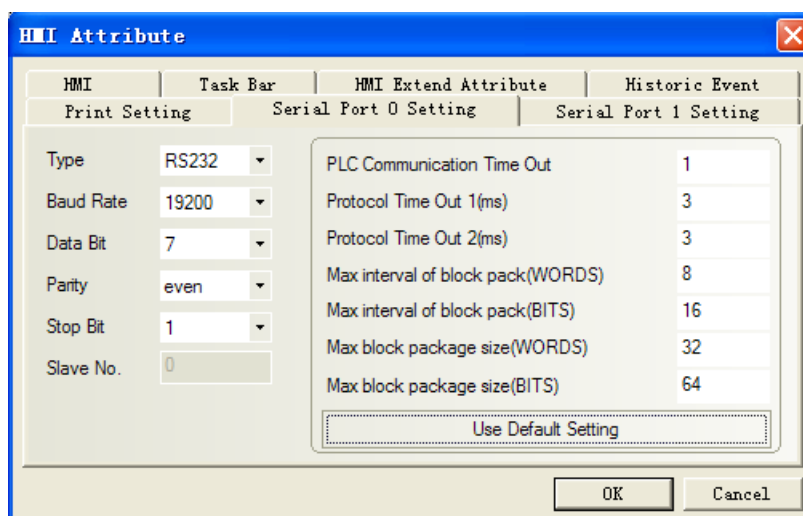

Note: CP1* baudrate 19200bps.

*: CP1 programming port is USB (RS232).

Supported Device

Device	Bit Address	Word Address	Format	Notes
Input Relay	X 0-255	-----	OOO	
Output Relay	Y 0-255	-----	OOO	
Internal Relay	M 0-5119	-----	DDDD	
Special Relay	SM 9000-9255	-----	DDDD	
Timer Relay	T_bit 0-255		DDD	
Counter Relay	C_bit 0-255		DDD	
Timer	-----	T_word 0-255	DDD	
Counter	-----	C_word 0-199	DDD	
Counter double word	-----	C_dword 200-255	DDD	
Data Register	-----	D 0-8191	DDDD	
Special Data Register	-----	SD 9000—9255	DDDD	

Cable Diagram

VH-14MR RS232 communication cable

1. Communication via USB programming port

Connection with HMI by programming cable of Vigor

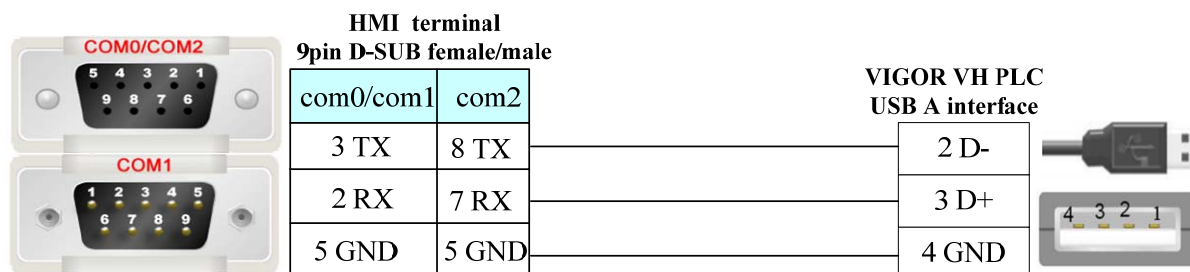

2. Communication via auxiliary interface of programming device:

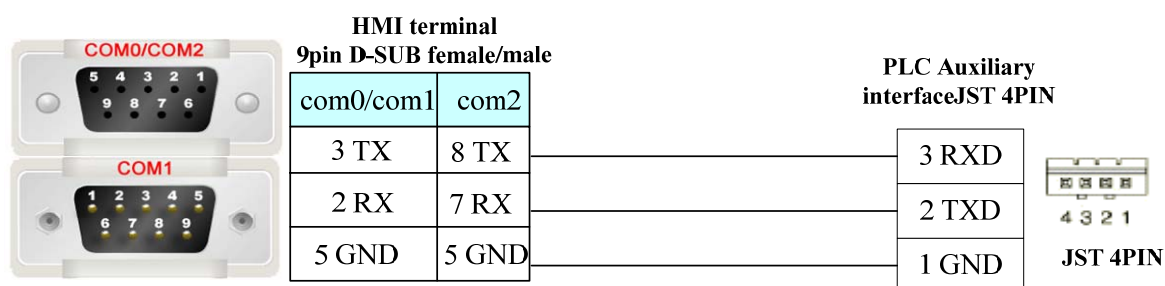

XiLin Inverter

Serial Communication

Series	CPU	Link Module	Driver
XiLin	EH600	RS485-2 on the CPU unit	XiLin EH600

System configuration

Series	CPU	Link Module	COM Type	Parameter	Cable
XiLin	EH600	RS485-2 on the CPU unit	RS485-2	Setting	Your owner cable

Communication Setting

RS485-2 Communication: 9600, 8, even, 1; station: 1

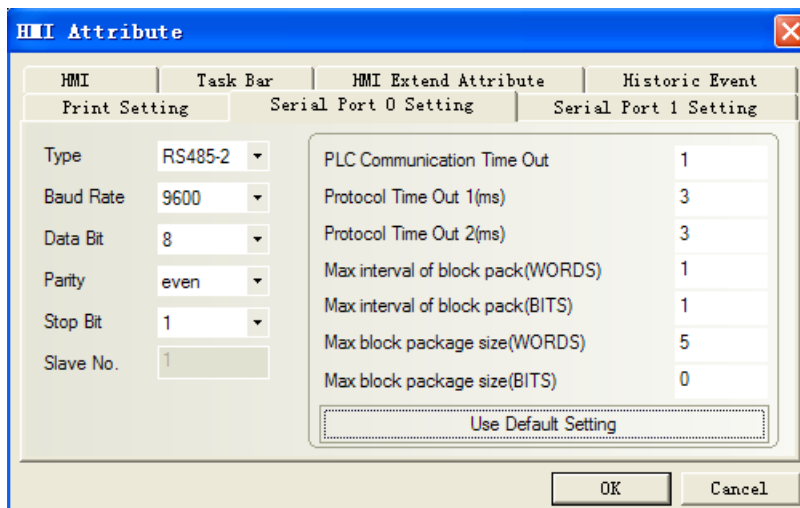

Supported Device

Device	Bit Address	Word Address	Format	Notes
Addr communication parameter	-----	Addr	HHHH	
A FWD	-----	A 0	D	
B REV	-----	B 0	D	
C FJOG	-----	C 0	D	
D RJOG	-----	D 0	D	
E Free halt	-----	E0	D	
F Slow down	-----	F 0	D	
G Reset failures	-----	G 0	D	

Address definition of frequency converter communication parameter

Please refer to XILIN frequency converter manual for details about device address.

Cable Diagram

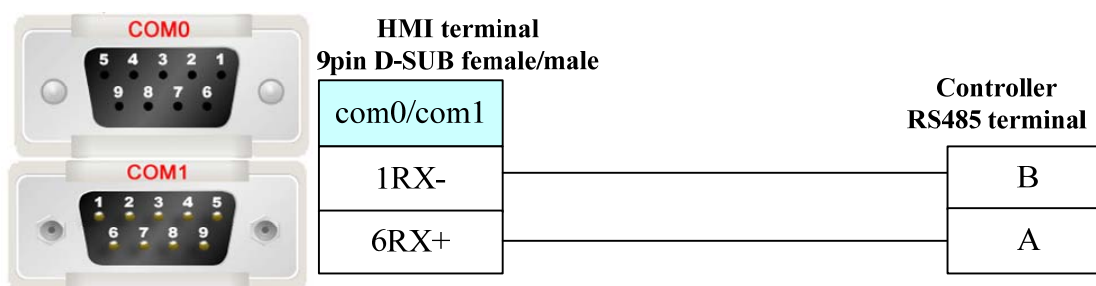

Yamatake Corporation

Serial Communication

Series	CPU	Link Module	Driver
DCP30	P30A□□□□□□2□□	RS485 on the CPU unit	Yamatake DCP30
SDC35/36	C35□□□□□□2□□	RS485 on the CPU unit	Yamatake SDC/DMC
	C35□□□□□□4□□		
	C36□□□□□□2□□		
	C36□□□□□□4□□		
DMC	DMC10D□□□□□□□□	RS485 on the CPU unit	
	DMC10S□□□□□□□□		

System configuration

Series	CPU	Link Module	COMM Type	Parameter	Cable
DCP30	P30A□□□□□□2□□	RS485 on the CPU unit	RS485	Setting	Your owner cable
SDC35/36	C35□□□□□□2□□	RS485 on the CPU unit	RS485	Setting	Your owner cable
	C35□□□□□□4□□				
	C36□□□□□□2□□				
	C36□□□□□□4□□				
DMC	DMC10D□□□□□□□□	RS485 on the CPU unit	RS485	Setting	Your owner cable
	DMC10S□□□□□□□□				

Communication Setting

HMI

DC30 RS485 default communication: 9600, 8, even, 1; station: 1

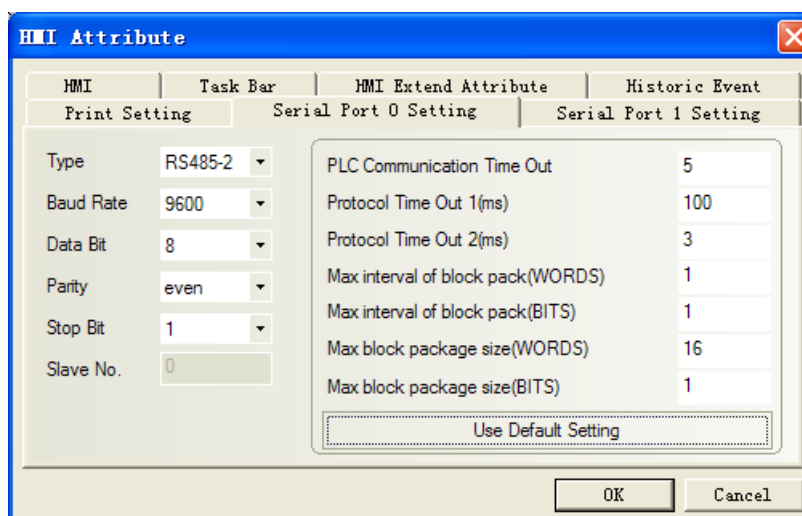

SDC36 RS485 default communication: 9600, 8, none, 1; station: 1

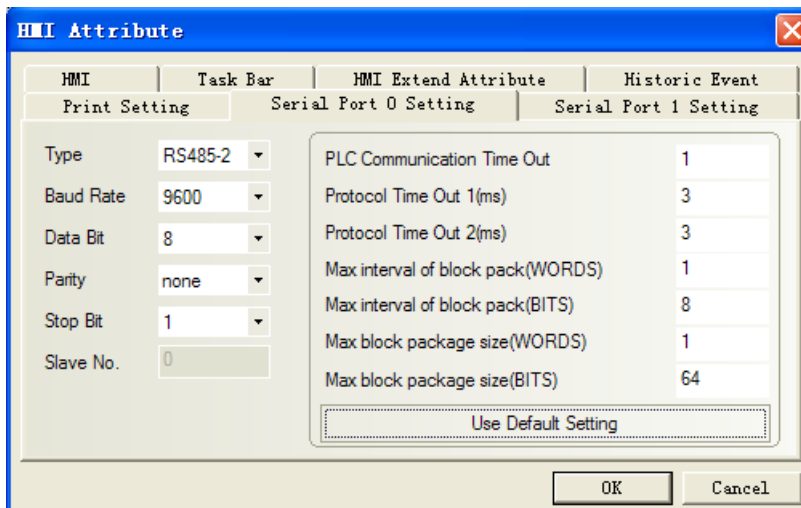

DMC RS485 default communication: 19200, 8, even, 1; station: 6.

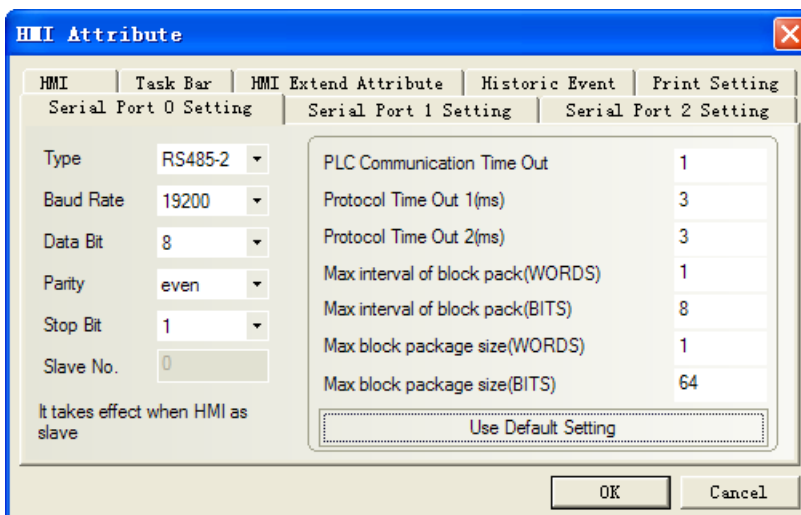

Plc 设置

1. Set modbus RTU in the SLP-D10, and then download.

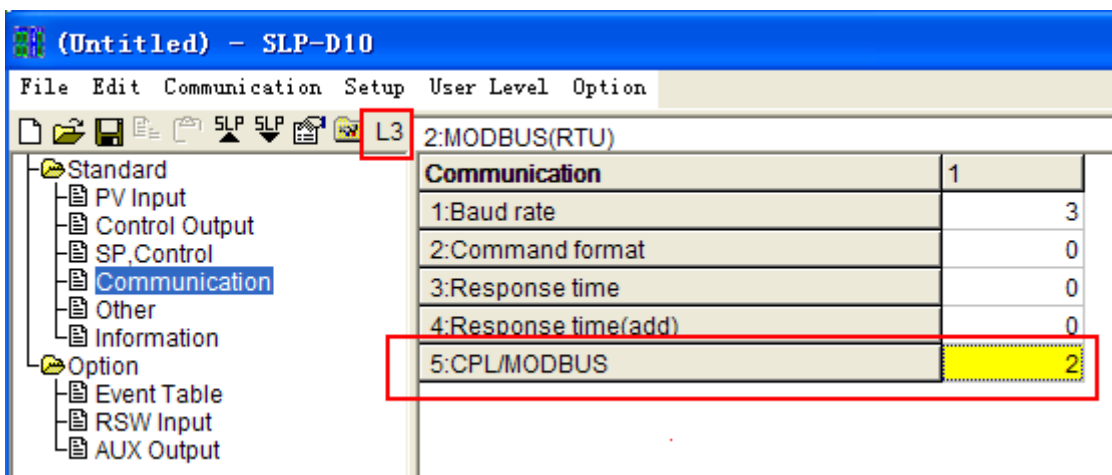

2. Station match with the switch on the device.

Supported Device

DCP30

Device	Bit Address	Word Address (Parameter code)	Format	Notes
RUN Status	-----	1-26	DDD	
PARA	-----	1-33	DDD	
EU	-----	1-13	DDD	
PID	-----	1-80	DDD	
SET	-----	1-99	DDD	
TBL	-----	1-22	DDD	
CNST	-----	1-26	DDD	
FO_R	1-19	-----	DDD	
FO_W	1-19	-----	DDD	
FC	1-19	-----	DDD	
FD	1-19	-----	DDD	
FBR1_R	-----	1.0-30.22	DDD.DD	
FBR2_R	-----	1.0-30.22	DDD.DD	
FBR3_R	-----	1.0-30.22	DDD.DD	
FBR4_R	-----	1.0-30.22	DDD.DD	
FBR5_R	-----	1.0-30.22	DDD.DD	
FBR6_R	-----	1.0-30.22	DDD.DD	
FBR7_R	-----	1.0-30.22	DDD.DD	
FBR8_R	-----	1.0-30.22	DDD.DD	
FBR9_R	-----	1.0-30.22	DDD.DD	
FBR10_R	-----	1.0-30.22	DDD.DD	
FBR11_R	-----	1.0-30.22	DDD.DD	
FBR12_R	-----	1.0-30.22	DDD.DD	
FBR13_R	-----	1.0-30.22	DDD.DD	
FBR14_R	-----	1.0-30.22	DDD.DD	
FBR15_R	-----	1.0-30.22	DDD.DD	
FBR16_R	-----	1.0-30.22	DDD.DD	
FBR17_R	-----	1.0-30.22	DDD.DD	
FBR18_R	-----	1.0-30.22	DDD.DD	
FBR19_R	-----	1.0-30.22	DDD.DD	

Please refer to the communication protocol for details.

H: HEX

Note:

1、SET C85 ----- Transmission rate, data type

0: 9600, even, stopbit 1;

1: 9600, none, stopbit 2;

2: 4800, even, stopbit 1;

3: 4800, none, stopbit 2.

2、SET C84 -----setting station No. **The value of C84 must be the same as the PLC's station No.**

When connecting multiple instruments, for distinguishing instruments, each instrument must be set C84 value with a different parameter. .

- 3、 Must press “FUNC+PARA” to set the parameter;
- 4、 PROG. have **19 numbers and** SEG have **30 numbers**, press DOWN key (sub) and PROG key (add) to change program number;
- 5、 Press “FUNC+PROG” to change the program.----every program must be set firstly and then communicate will be ok, or else “PLC Response Error” will print;
- 6、 After “RUN/HLD” light on, many parameters can't be modified(e.g. SET) In order to reset, press “ PROG+RUN/HOLD” .

Modify the parameter at the state of “DISP”, not at the state of “INPUT”;

- 7、 On the temperature controller, time parameters show number with sexagesimal.

(Example it shows 2222 on the screen, but on the controller panel shows 37.02---- $37.00 \times 60 + 2 = 2222$)

- 8、 PROG's address setting:

FBR1_R indicates prog 1. (e.g. PROG 1) format: DDD.DD. Main address DDD indicates seg No, subaddress DD indicates parameter value, the correspondence as follows

(Example: FBR1_R address 11.10 indicates PROG 1,SEG 1,T1 2nd)

Sub addr DD correspond to temperature controller:

Sub Addr	Parameter	Sub Addr	Parameter
.0	SP	.12	T2 2nd
.1	TM	.13	T3 1st
.2	None (Skip)	.14	T3 2nd
.3	EV1	.15	T4 1st
.4	Blank	.16	T4 2nd
.5	EV2	.17	T5 1st
.6	Blank	.18	T5 2nd
.7	EV3	.19	PID
.8	Blank	.20	None (Skip)
.9	T1 1st	.21	9.5.
.10	T1 2nd	.22	9.5.to
.11	T2 1st		

SDC36 (Please refer to the manual of yamatake SDC36 for details)

Device	Bit Address	Word Address	Format	Notes
Data Register	————	4X 0-65535	DDDDD	

DMC (Please refer to the manual of DMC-SPL for details, in 10-8 communication parameters)

Device	Bit Address	Word Address	Format	Notes
Data Register	————	4X 1002-65535	DDDDD	Address add 1 to the list of communication parameters

Example: ch1 pv is according to 4x1005 in the EV5000.

Cable Diagram

DC30 RS485 communication cable

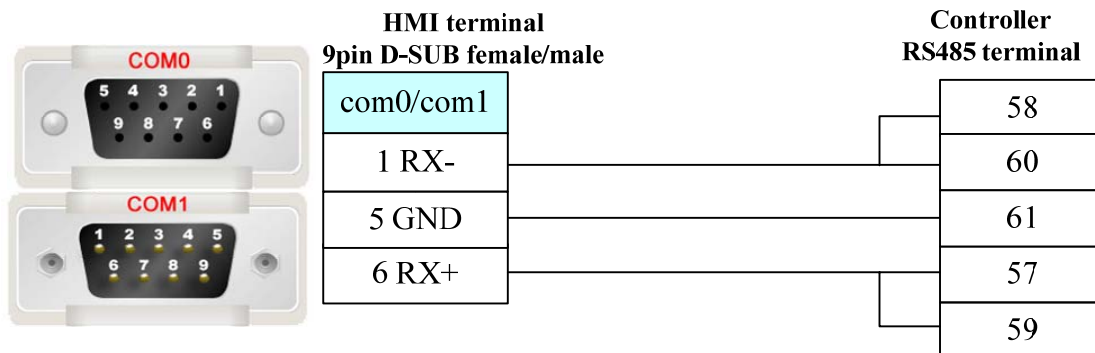

RS232 communication, need to use *RS-232 to RS-422/485* converter

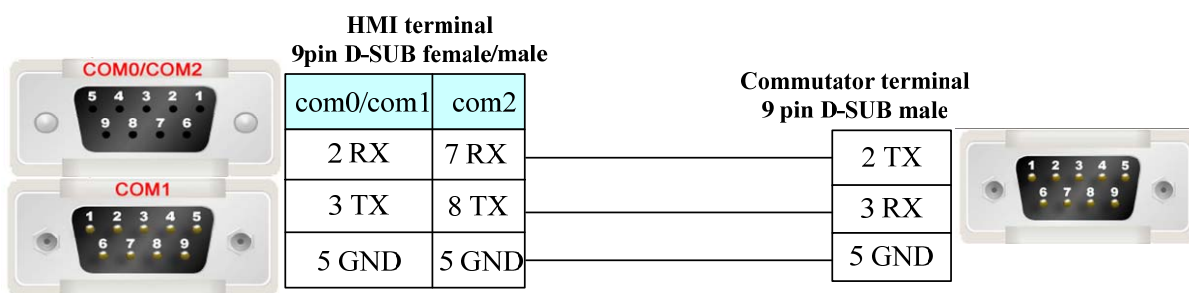

SDC36 RS485 communication

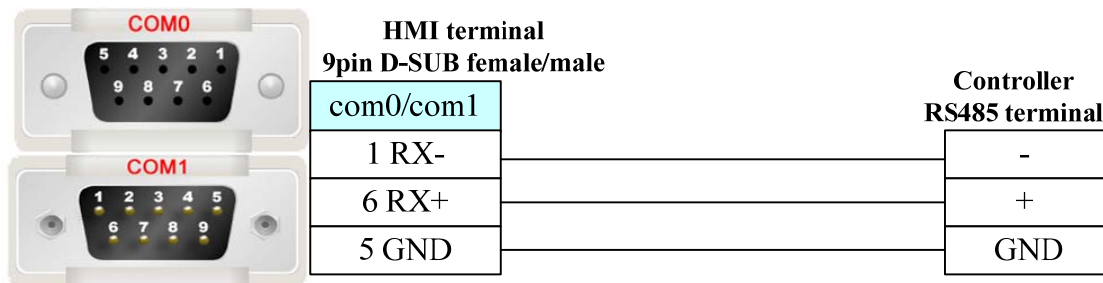

DMC RS485 communication

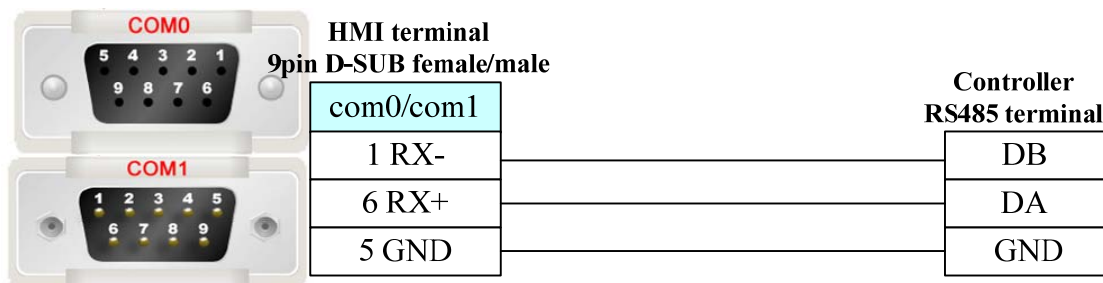

Yaskawa Inverter

Serial Communication

Series	CPU	Link Module	Driver
V		RS485 on the CPU unit	Yaskawa AH Modbus RTU

System configuration

Series	CPU	Link Module	COM Type	Parameter	Cable
V		RS485 on the CPU unit	RS485-2	Setting	Your owner cable

Communication Setting

Default communication: 9600, 8, even, 1; station: 1

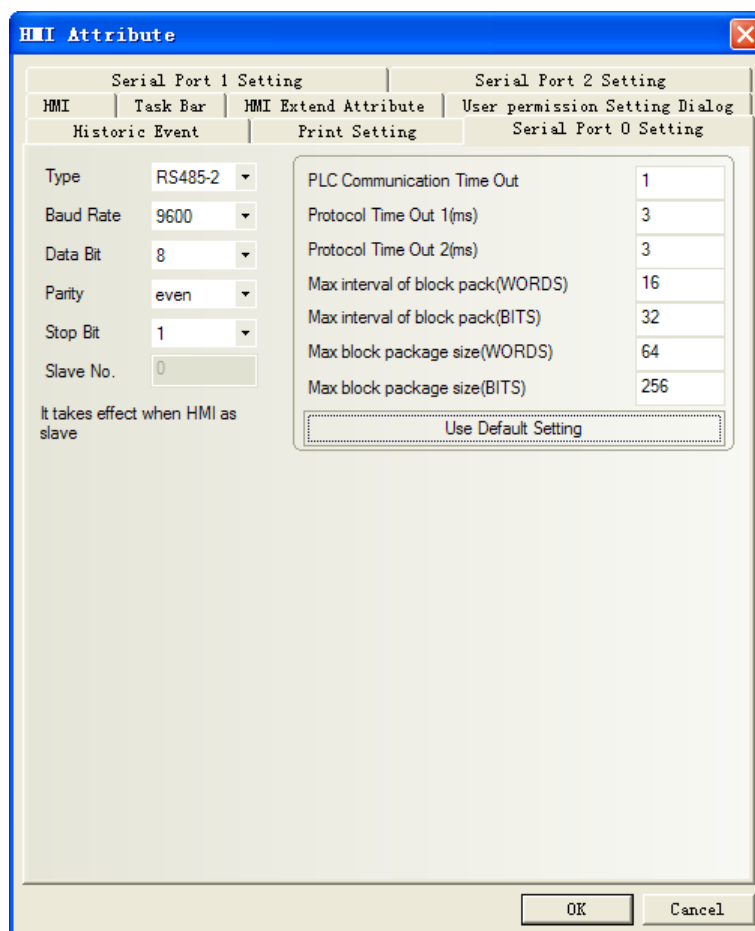

Supported Device

Device	Bit Address	Word Address	Format	Notes
Internal/external output node	0X1-65535	-----	DDDDD	
Internal/external input node	1X1-65535	-----	DDDDD	

Simulant input data register	-----	3X1-65535	DDDDD	
data register	-----	4X1-65535	DDDDD	

Node: this drive can not provide write batch of word part

Cable Diagram

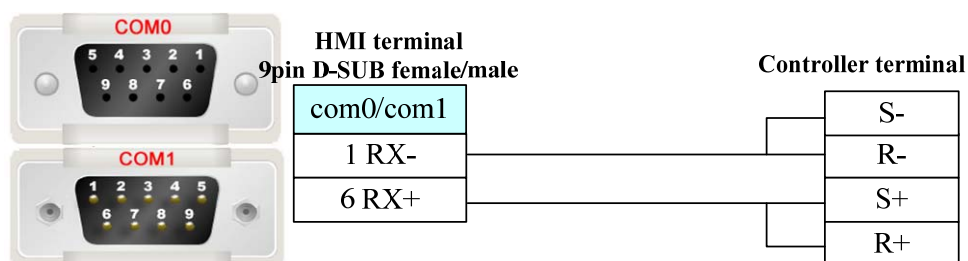

Yaskawa UDP

Network communication (support indirect online and direct online)

Series	CPU	Link Module	Driver
MP series	MP2400	ETH on the CPU unit	Yaskawa UDP

System configuration

Series	CPU	Link Module	COMM Type	Parameter	Cable
MP series	MP2400	ETH on the CPU unit	ETH	Setting	Your owner cable

Communication Setting

Network communication

※Project construction

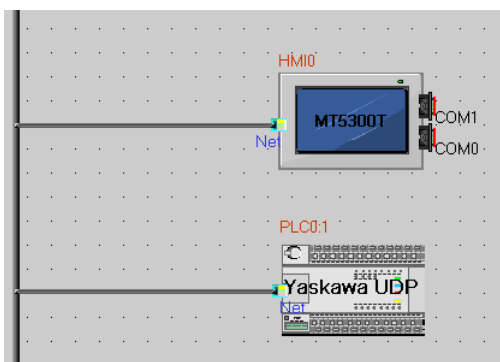

※HMI Attribute

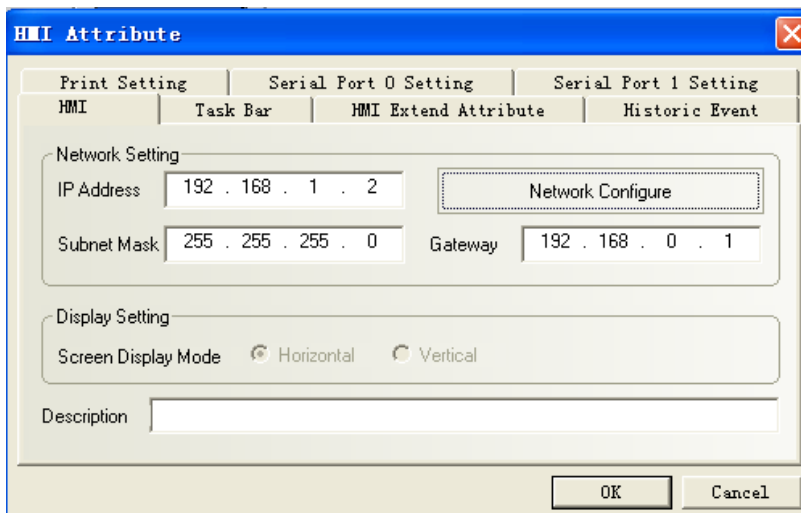

※PLC Attribute (station is not necessary)

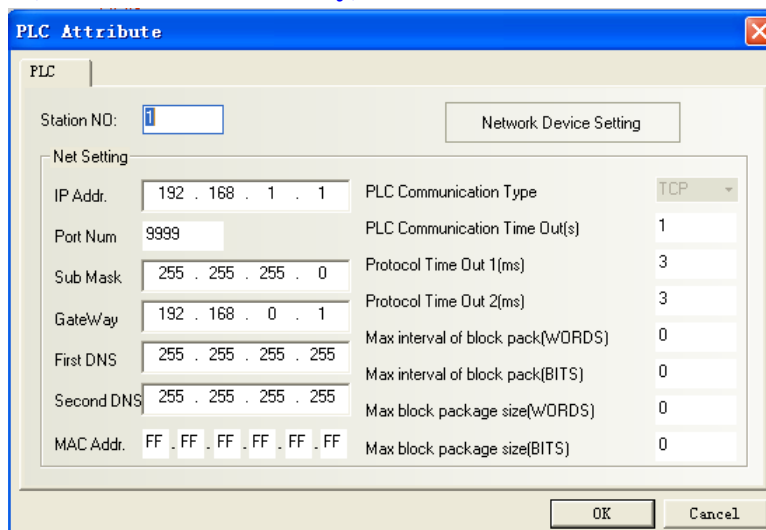

※Network configuration (Note: IP and port must be set correct, that is set as MPE720 software.)

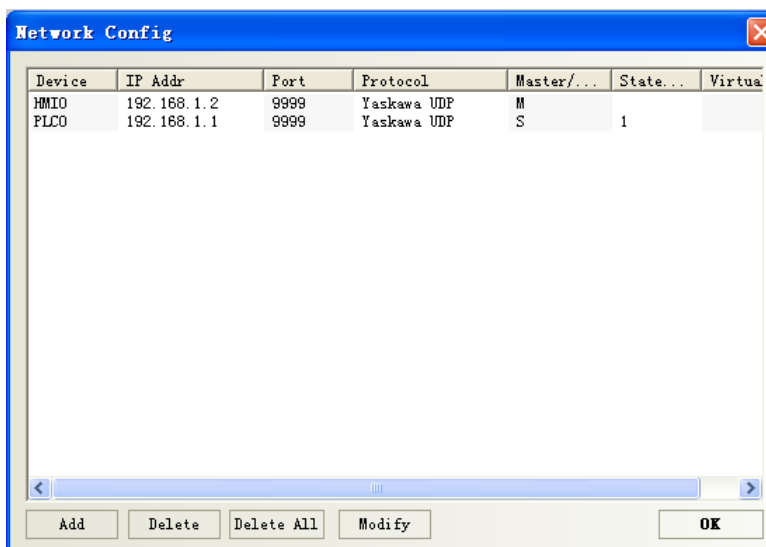

PLC software setting

1. set the IP, connect with the MPE720 software

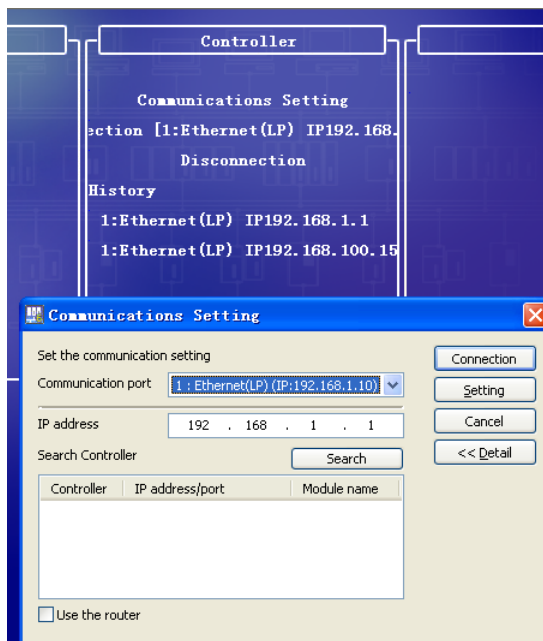

2. how to set the IP

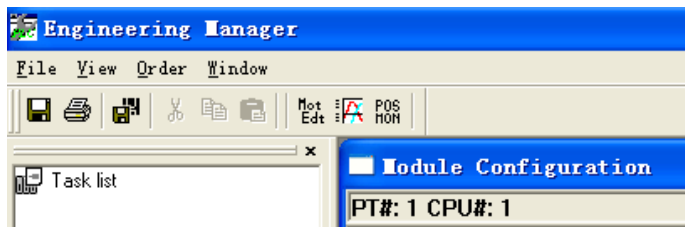
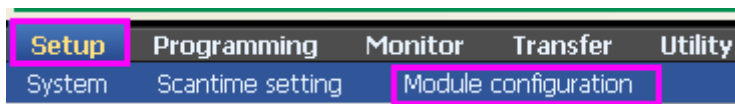

2	↑↓
2181FA	▼
01	
01	双击
0000	
07FF	
Enable	▼
Enable	▼

Running	

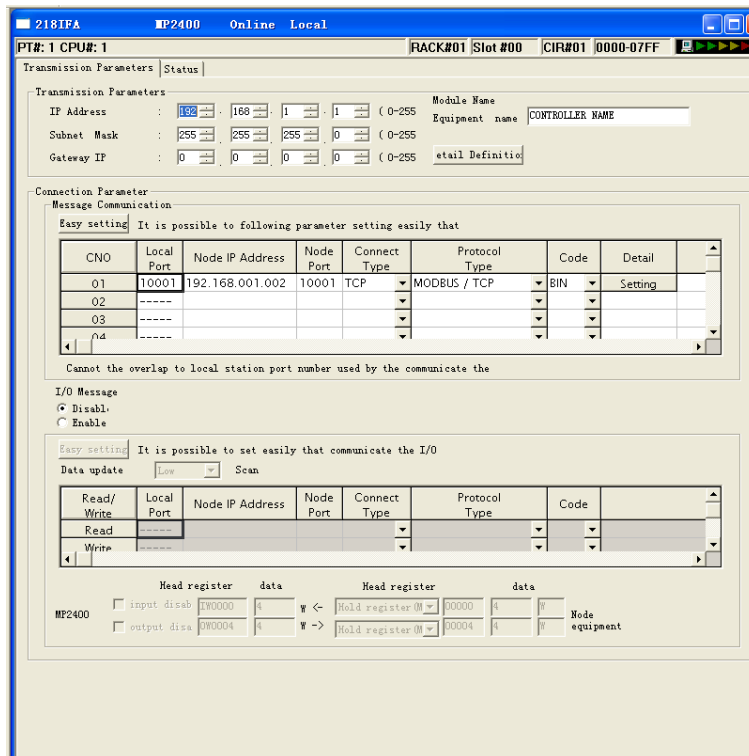

Change, save, and save to flash:

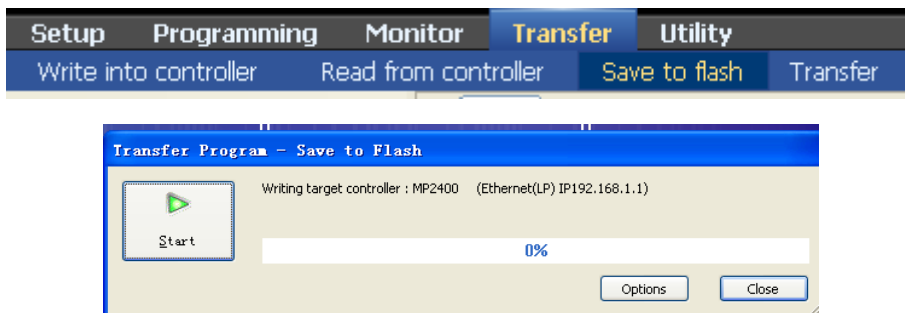

Restart the controller and the set is ok.

If online, then you can monitoring the data:

Monitor single data:

Watch 1		
Variable	Value	Comment
IW0000	-32768	
OW0000		

Monitor the Register:

Register List 1								
Register	0	1	2	3	4	5	6	7
MW00000	-1	1212	127	0	0	0	0	0
MW00016	0	0	0	0	0	0	0	0
MW00032	0	0	0	0	0	0	0	0
MW00048	0	0	0	0	0	0	0	0
MW00064	0	0	0	0	0	0	0	0
MW00080	0	0	0	0	0	0	0	0

Supported Device

Device	Bit Address	Word Address	Format	Notes
Input register node	IB0000.0-FFFF.F	-----	HHHHH.H	
Output register node	OB0000.0-FFFF.F	-----	HHHHH.H	
holding register node	MB00000.0-65534.F	-----	DDDDD.H	
Input register	-----	IW0000-FFFF	HHHH	
Output register	-----	OW0000-FFFF	HHHH	
Holding register	-----	MW00000-65534	DDDDD	

Note: In the EV5000 software, bit address format is HHHH.H, but there is no point in the controller. E.g.: In the EV5000 software, the bit address is MB65534.F, but there is no point in the controller, and it is MB65534F. We set the I/O address as large as enough, and we found the big address can't be written, but it is the same effect with the monitoring.

Cable Diagram

Cross-connection or crossover network cable can be used as communication cable via the hub or switch

a. Cross-connection cable diagram

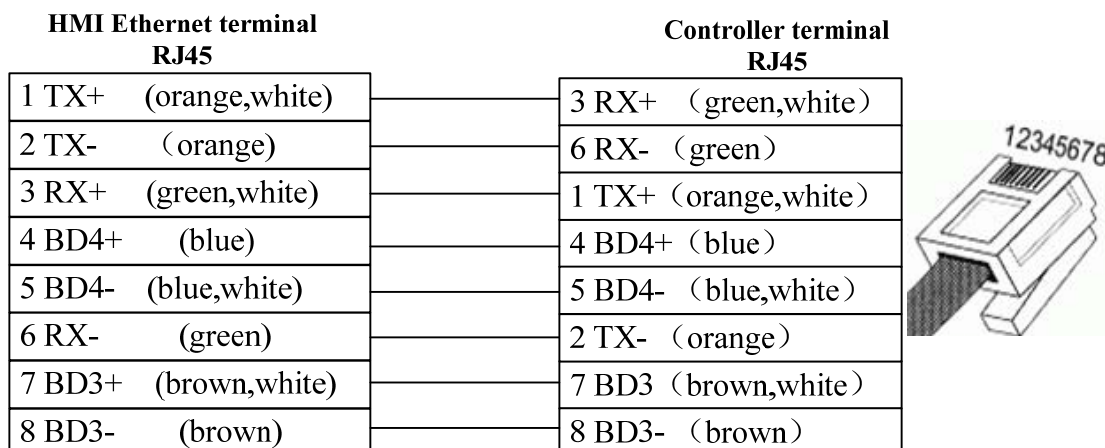

b. crossover network cable diagram

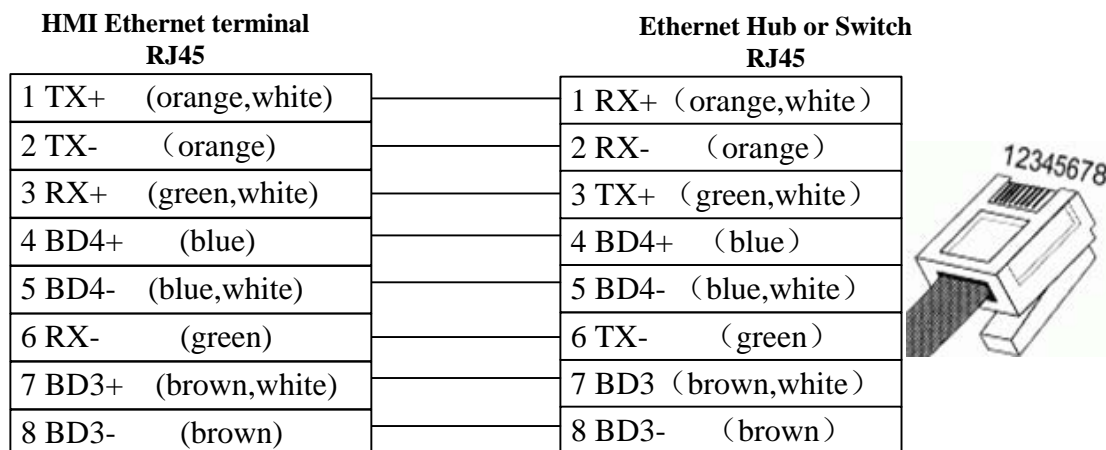

Yaskawa MP2300 (Motion Controller)

Serial Communication

Series	CPU	Link Module	Driver
MP	MP2300	RS232 on the CPU unit	YASKAWA MP2300

System configuration

Series	CPU	Link Module	COM Type	Parameter	Cable
MP	MP2300	RS232 on the CPU unit	RS232	Setting	Your owner cable

Supported Device

Device	Bit Address	Word Address	Format	Notes
Coil	MB0.0-4095.F	-----	DDDD.H	
Input Relay	IB 0.0-FFF.F	-----	HHHH.H	
Hold Register	-----	MW 0-65534	DDDDD	
Input Register	-----	IW 0-7FFF	HHHH	

Note: IB0.0-0.F are occupied by the system; IW0 is occupied by the system.

Communication Setting

Default communication: 19200, 8, even, 1; station: 1

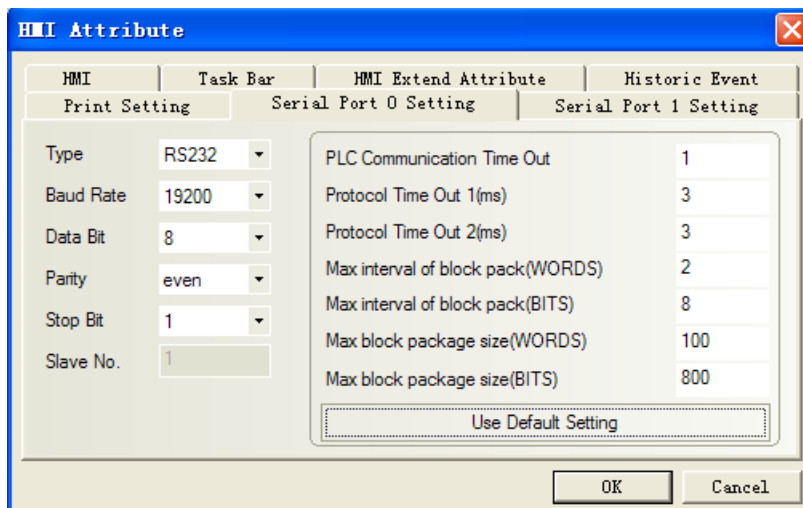

Cable Diagram

MP2300 RS232 communication cable

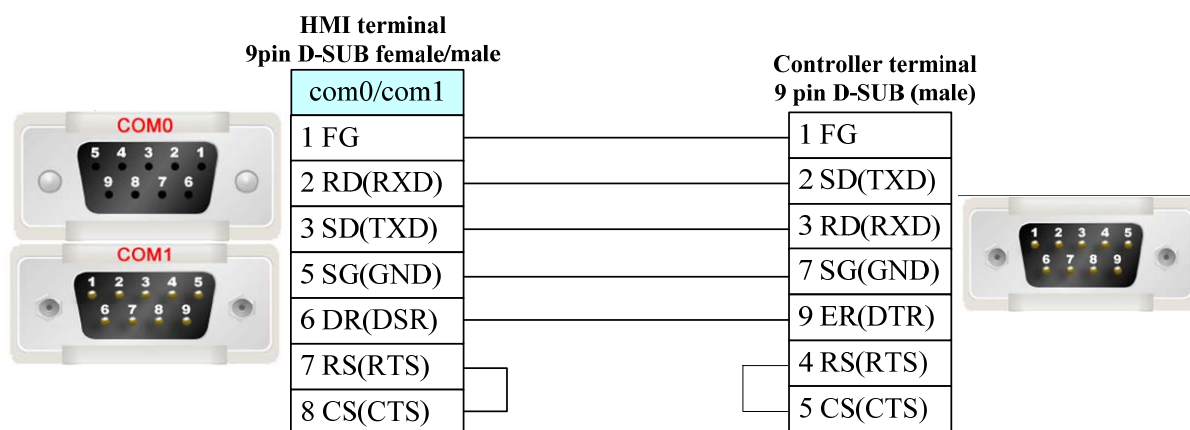

Yaskawa SGDM (Servo Controller)

Serial Communication

Series	CPU	Link Module	Driver
Σ II/Σ II Plus	SGDM	RS232 on the CPU unit	YASKAWA SGDM
		RS422 on the CPU unit	

System configuration

Series	CPU	Link Module	COM Type	Parameter	Cable
Σ II/Σ II Plus	SGDM	RS232 on the CPU unit	RS232	Setting	Your owner cable
		RS422 on the CPU unit	RS485-4	Setting	Your owner cable

Communication Setting

Default communication: 9600, 7, even, 1; station: 0

RS232 communication

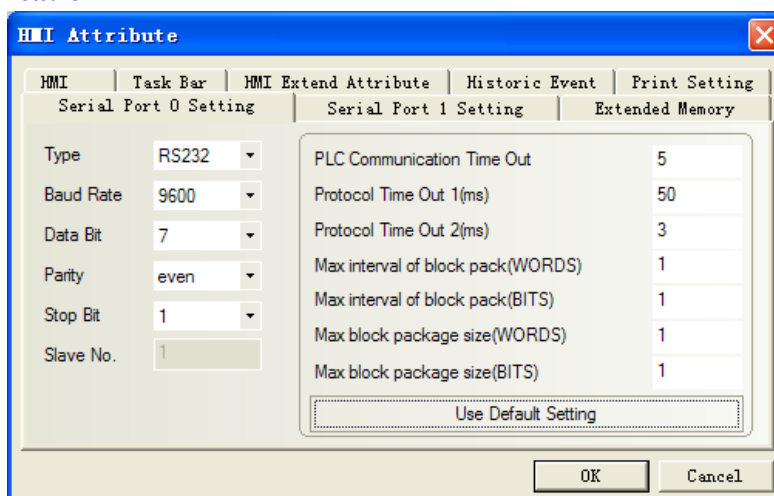

RS422 communication

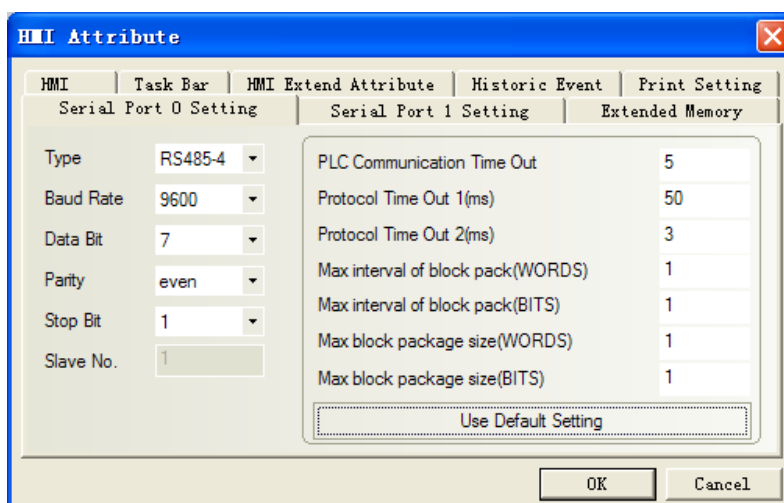

Supported Device

Device	Bit Address	Word Address	Format	Notes
Function Selection Basic Switches	-----	Pn000 ~ Pn003	HHH	
Speed Loop Gain and so on	-----	Pn100 ~ Pn118	HHH	
Position Control Reference	-----	Pn200 ~ Pn205	HHH	
Speed Control Reference	-----	Pn300 ~ Pn308	HHH	
Torque Control Reference	-----	Pn400 ~ Pn407	HHH	
Sequence Reference	-----	Pn500 ~ Pn510	HHH	
Other	-----	Pn600 ~ Pn601	HHH	
Monitor mode	-----	Un000 ~ Un00D	HHH	

Cable Diagram

RS232 communication cable

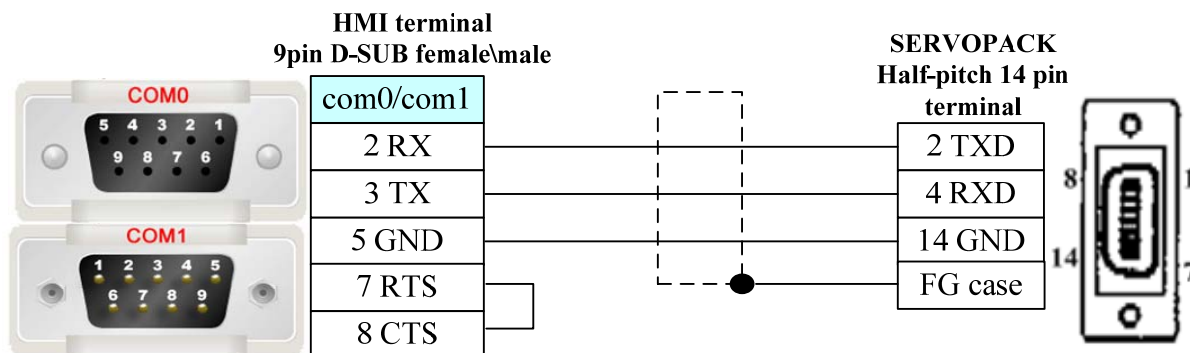

RS422 communication cable

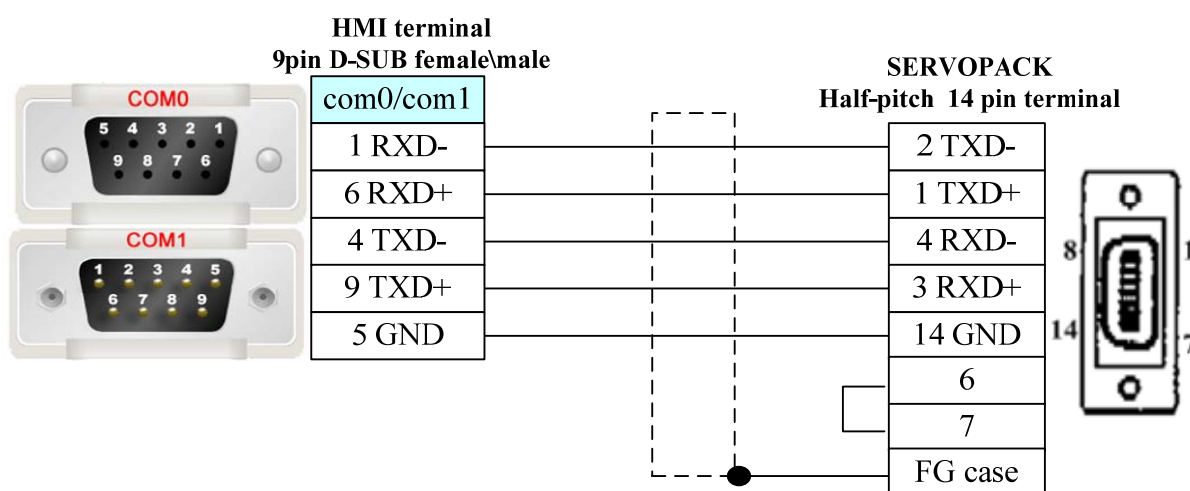

YuDian AI

Serial Communication

Series	CPU	Link Module	Driver
AI	AI-518 AI-701	RS485 on the CPU unit	YuDian AI Single_Loop
	AI-7048	RS485 on the CPU unit	YuDian AI 4_Loop

System configuration

Series	CPU	Link Module	COMM Type	Parameter	Cable
AI	AI-518 AI-701	RS485 on the CPU unit	RS485	Setting	Your owner cable
	AI-7048	RS485 on the CPU unit	RS485	Setting	Your owner cable

Communication Setting

RS485 default communication: 9600, 8, none, 1; station: 1

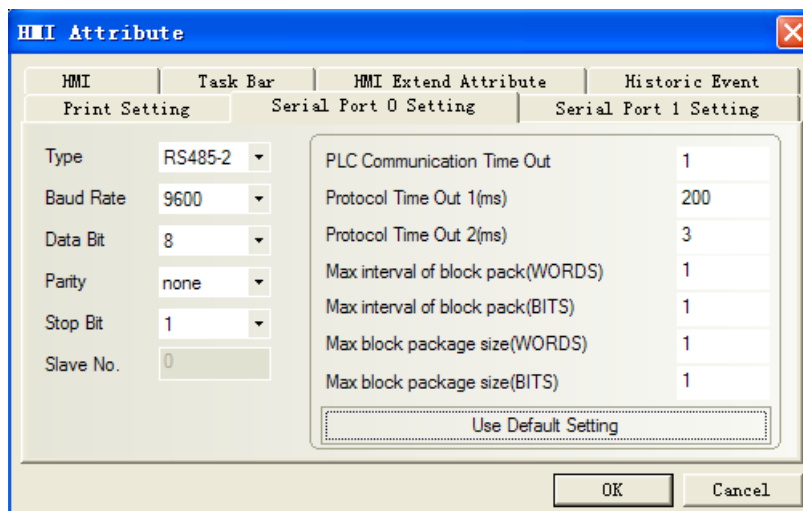

SPECIAL NOTE:

For example: If station number is 2, register PV0.0 denotes channel 2, and PV1.0 denotes channel 3 (station number 2+main address 1).

Thereinto the setting of station number is very important, it denotes start address of the controller (viz. instrument address in instrument parameter), and main address just denotes 4 channels. When main address is 0, it denotes channel (station number+0)

Supported Device

AI-518

Device	Bit Address	Word Address			Format
SV/STEP	-----	0	00H		DD
HIAL	-----	1	01H	-1999~+9999	DD
LoAL	-----	2	02H	-1999~+9999	DD
dHAL	-----	3	03H	0~9999	DD
dLAL	-----	4	04H	0~9999	DD
dF	-----	5	05H	0~2000	DD
Ctrl	-----	6	06H	0~4	DD
M5	-----	7	07H	0~9999	DD
P	-----	8	08H	1~9999	DD
t	-----	9	09H	0~2000	DD
CtI	-----	10	0AH	0~125	DD
Sn (Read Only)	-----	11	0BH	0~37	DD
dIP (Read Only)	-----	12	0CH	0~3	DD
dIL	-----	13	0DH	-1999~+9999	DD

dIH	-----	14	0EH	-1999~+9999	DD
ALP	-----	15	0FH	0~9999	DD
Sc	-----	16	10H	-1999~+4000 0.1℃	DD
Op1	-----	17	11H	0~48	DD
oPL	-----	18	12H	-110~+110%	DD
oPH	-----	19	13H	0~110%	DD
CF (Read Only)	-----	20	14H	0~127	DD
Baudrate(bAud)/808P running status control word: run:0 pause:4 stop:12(read only)	-----	21	15H	0~19.2K	DD
ADDR	-----	22	16H	0~100	DD
dL	-----	23	17H	0~20	DD
run	-----	24	18H	0~127	DD
Loc	-----	25	19H	0~9999	DD

AI-701

Device	Bit Address	Word Address			Format
HIAL	-----	1	01H	-9990~+30000	DD
LoAL	-----	2	02H	-9990~+30000	DD
HdAL	-----	3	03H	-9990~+30000	DD
LdAL	-----	4	04H	-9990~+30000	DD
AHYS	-----	5	05H	0~2000	DD
InP (Read Only)	-----	11	0BH	0~37	DD
dPt	-----	12	0CH	0~3	DD
SCL	-----	13	0DH	-9999~+30000	DD
SCH	-----	14	0EH	-9999~+30000	DD
AOP	-----	15	0FH	0~4444	DD
Scb	-----	16	10H	-1999~+4000 0.1℃	DD
Opt	-----	17	11H	0~48	DD
Baudrate(bAud)/808P running status control word: run:0 pause:4 stop:12(read only)	-----	21	15H	0~19.2K	DD
ADDR	-----	22	16H	0~80	DD
FILt	-----	23	17H	0~40	DD
Loc	-----	25	19H	0~255	DD

- Note:** 1、When setting the parameter of ADDR, it match the PLC Station Number .
2、If connecting many devices, you should set different ADDR values.

AI-7048

Device	Bit Address	Word Address	Format	Notes
PV	-----	0.0-3.0	D.D	Read only
SV	-----	0.0-3.0	D.D	
Reference	-----	0.0-3.86	D.D	

Reference

Device	Bit Address	Word Address		Format	
SP	-----	0	00H	-1999-30000	DDD.DDD
HIAL	-----	1	01H	-1999~+9999	DDD.DDD
LoAL	-----	2	02H	-1999~+9999	DDD.DDD
	-----	3	03H		DDD.DDD
	-----	4	04H		DDD.DDD
AHYS	-----	5	05H	0~2000	DDD.DDD
AT	-----	6	06H	0~4	DDD.DDD
P	-----	7	07H	0~9999	DDD.DDD
I	-----	8	08H	0~9999	DDD.DDD
d	-----	9	09H	0~2000	DDD.DDD
	-----	10	0AH		DDD.DDD
InP	-----	11	0BH	0~42	DDD.DDD
dPt	-----	12	0CH	0~3	DDD.DDD
SCL	-----	13	0DH	0~+9999	DDD.DDD
SCH	-----	14	0EH	0~+9999	DDD.DDD
AOP	-----	15	0FH	0~31	DDD.DDD
Scb	-----	16	10H	-1999~+2000 0.1℃	DDD.DDD
	-----	17	11H		DDD.DDD
	-----	18	12H		DDD.DDD
OPH	-----	19	13H	0~220	DDD.DDD
AF	-----	20	14H	0~15	DDD.DDD
Meter condition code	-----	21	15H	0~19.2K	DDD.DDD
ADDR	-----	22	16H	0~64	DDD.DDD
FILt	-----	23	17H	0~20	DDD.DDD
Nonc	-----	24	18H	0~7	DDD.DDD
Loc	-----	25	19H	0~9999	DDD.DDD
Cn	-----	26	1AH	0-4	DDD.DDD

NOTE:

- 1、 When setting the parameter of ADDR, it match the PLC Station Number.
- 2、 If connecting many devices, you should set different ADDR values.
- 3、 AI-7048 has 4 loops, so it occupies 4 address, For instance, Addr=5, address 5~8 were used by

this controller, other controller can't use address 5~8.

Cable Diagram

RS485 communication cable

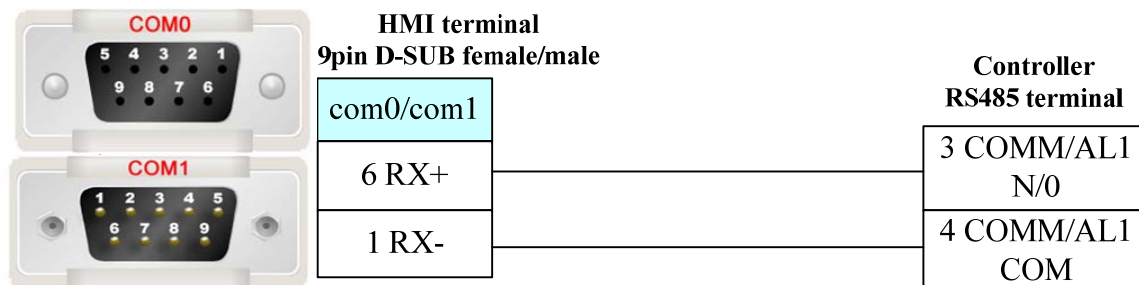

RS232 communication, need to use *RS-232 to RS-422/485* converter

